



SGM8261-1/SGM8261-2

Bipolar-Input, High Performance, Ultra-Low Noise Operational Amplifiers

GENERAL DESCRIPTION

The single SGM8261-1 and dual SGM8261-2 are bipolar-input, low noise operational amplifiers optimized for high voltage systems. These devices operate from 3.6V to 36V single supply or from $\pm 1.8V$ to $\pm 18V$ dual power supplies, while consuming 3.8mA quiescent current per amplifier.

The SGM8261-1/2 have impressive dynamic characteristics with various loads. The rail-to-rail output swing with a 2k Ω load is within 185mV of the rails. This results in large headroom and wide dynamic range. The SGM8261-1/2 are unity-gain stable and offer a $\pm 65mA$ high output current. They feature $1.6nV/\sqrt{Hz}$ ultra-low noise at 1kHz with 0.00002% distortion.

The SGM8261-1 is available in a Green SOIC-8 package. The SGM8261-2 is available in Green SOIC-8, MSOP-8 and TDFN-3 \times 3-8BL packages. They operate over an ambient temperature range of $-40^{\circ}C$ to $+85^{\circ}C$.

FEATURES

- **Excellent Sound Quality**
- **Ultra-Low Input Voltage Noise: $1.6nV/\sqrt{Hz}$ at 1kHz**
- **Ultra-Low Distortion: 0.00002% at 1kHz**
- **Unity-Gain Stable**
- **Gain-Bandwidth Product: 16MHz (G = +1)**
- **High Slew Rate: 16V/ μ s**
- **High Open-Loop Gain: 140dB**
- **Low Offset Voltage: $\pm 350\mu V$ (MAX)**
- **Rail-to-Rail Output**
- **Support Single or Dual Power Supplies:
3.6V to 36V or $\pm 1.8V$ to $\pm 18V$**
- **Low Quiescent Current: 3.8mA/Amplifier**
- **$-40^{\circ}C$ to $+85^{\circ}C$ Operating Temperature Range**
- **Small Packaging:
SGM8261-1 Available in a Green SOIC-8 Package
SGM8261-2 Available in Green SOIC-8, MSOP-8
and TDFN-3 \times 3-8BL Packages**

APPLICATIONS

Professional Audio Instrument
High-End A/V Receiving Machines
Analog and Digital Mixing Control Boards

PACKAGE/ORDERING INFORMATION

MODEL	PACKAGE DESCRIPTION	SPECIFIED TEMPERATURE RANGE	ORDERING NUMBER	PACKAGE MARKING	PACKING OPTION
SGM8261-1	SOIC-8	-40°C to +85°C	SGM8261-1YS8G/TR	SGM 82611YS8 XXXXXX	Tape and Reel, 2500
SGM8261-2	SOIC-8	-40°C to +85°C	SGM8261-2YS8G/TR	SGM 82612YS8 XXXXXX	Tape and Reel, 2500
	MSOP-8	-40°C to +85°C	SGM8261-2YMS8G/TR	SGM82612 YMS8 XXXXXX	Tape and Reel, 4000
	TDFN-3x3-8BL	-40°C to +85°C	SGM8261-2YTDD8G/TR	SGM 82612DD XXXXXX	Tape and Reel, 4000

MARKING INFORMATION

NOTE: XXXXX = Date Code and Vendor Code.

XXXXX

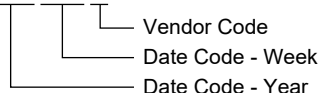

Green (RoHS & HSF): SG Micro Corp defines "Green" to mean Pb-Free (RoHS compatible) and free of halogen substances. If you have additional comments or questions, please contact your SGMICRO representative directly.

ABSOLUTE MAXIMUM RATINGS

- Supply Voltage, +Vs to -Vs 40V
- Input Voltage Range (-Vs) - 0.3V to (+Vs) + 0.3V
- Input Current (All pins except power supply pins)..... ±10mA
- Output Short-Circuit Current ±100mA
- Junction Temperature +150°C
- Storage Temperature Range -65°C to +150°C
- Lead Temperature (Soldering, 10s) +260°C
- ESD Susceptibility
- HBM 8000V
- MM 300V
- CDM 1000V

RECOMMENDED OPERATING CONDITIONS

- Operating Temperature Range -40°C to +85°C

OVERSTRESS CAUTION

Stresses beyond those listed in Absolute Maximum Ratings may cause permanent damage to the device. Exposure to absolute maximum rating conditions for extended periods

may affect reliability. Functional operation of the device at any conditions beyond those indicated in the Recommended Operating Conditions section is not implied.

ESD SENSITIVITY CAUTION

This integrated circuit can be damaged if ESD protections are not considered carefully. SGMICRO recommends that all integrated circuits be handled with appropriate precautions. Failure to observe proper handling and installation procedures can cause damage. ESD damage can range from subtle performance degradation to complete device failure. Precision integrated circuits may be more susceptible to damage because even small parametric changes could cause the device not to meet the published specifications.

DISCLAIMER

SG Micro Corp reserves the right to make any change in circuit design, or specifications without prior notice.

PIN CONFIGURATIONS

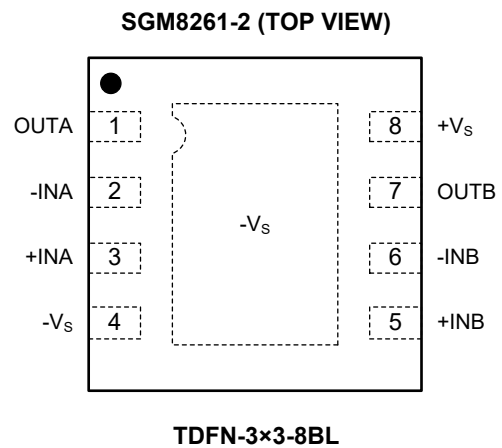
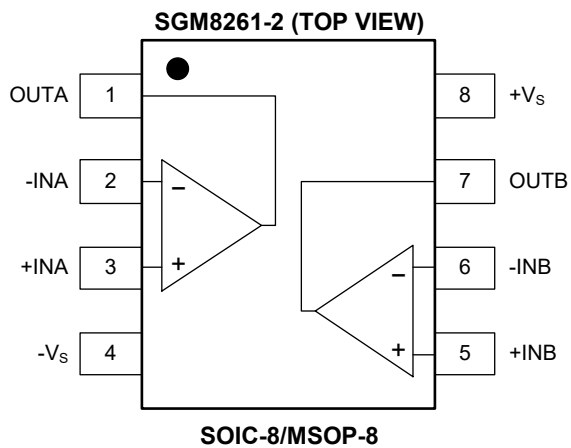
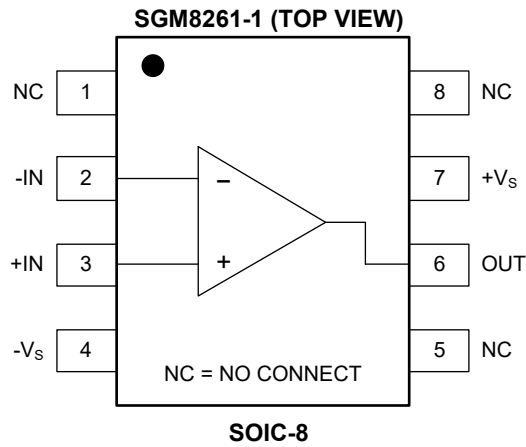

NOTE: For TDFN-3x3-8BL package, connect exposed pad to -Vs.

ELECTRICAL CHARACTERISTICS

(At $T_A = +25^\circ\text{C}$, $V_S = 4.5\text{V}$ to 36V or $V_S = \pm 2.25\text{V}$ to $\pm 18\text{V}$, $R_L = 2\text{k}\Omega$, $V_{CM} = V_{OUT} = V_S/2$, unless otherwise noted.)

PARAMETER	CONDITIONS	MIN	TYP	MAX	UNITS
Input Characteristics					
Input Offset Voltage (V_{OS})	$V_S = \pm 15\text{V}$		± 100	± 350	μV
	$-40^\circ\text{C} \leq T_A \leq +85^\circ\text{C}$			± 450	
Input Offset Voltage Drift ($\Delta V_{OS}/\Delta T$)	$V_S = \pm 15\text{V}$		1		$\mu\text{V}/^\circ\text{C}$
Input Bias Current (I_B)	$V_{CM} = V_{OUT} = V_S/2$		± 40	± 300	nA
	$-40^\circ\text{C} \leq T_A \leq +85^\circ\text{C}$			± 550	
Input Offset Current (I_{OS})	$V_{CM} = V_{OUT} = V_S/2$		± 25	± 165	nA
Input Common Mode Voltage Range (V_{CM})		$(-V_S) + 1.8$		$(+V_S) - 1.8$	V
Common Mode Rejection Ratio (CMRR)	$V_S = 4.5\text{V}$, $(-V_S) + 1.8\text{V} \leq V_{CM} \leq (+V_S) - 1.8\text{V}$	102	120		dB
	$-40^\circ\text{C} \leq T_A \leq +85^\circ\text{C}$	99			
	$V_S = 36\text{V}$, $(-V_S) + 1.8\text{V} \leq V_{CM} \leq (+V_S) - 1.8\text{V}$	122	135		
	$-40^\circ\text{C} \leq T_A \leq +85^\circ\text{C}$	110			
Open-Loop Voltage Gain (A_{OL})	$(-V_S) + 0.2\text{V} \leq V_{OUT} \leq (+V_S) - 0.2\text{V}$, $R_L = 10\text{k}\Omega$	110	140		dB
	$-40^\circ\text{C} \leq T_A \leq +85^\circ\text{C}$	107			
	$(-V_S) + 0.6\text{V} \leq V_{OUT} \leq (+V_S) - 0.6\text{V}$, $R_L = 2\text{k}\Omega$	112	140		
	$-40^\circ\text{C} \leq T_A \leq +85^\circ\text{C}$	109			
Input Impedance					
Differential			$32\text{k} \parallel 10$		$\Omega \parallel \text{pF}$
Common Mode			$10^9 \parallel 4$		$\Omega \parallel \text{pF}$
Output Characteristics					
Output Voltage Swing from Rail	$R_L = 10\text{k}\Omega$		± 40	± 65	mV
	$R_L = 2\text{k}\Omega$		± 185	± 275	
Output Short-Circuit Current (I_{SC})			± 65		mA
Audio Performance					
Total Harmonic Distortion + Noise (THD+N)	$G = +1$, $V_{OUT} = 3V_{RMS}$, $f = 1\text{kHz}$		0.00002		%
			-134		dB
Intermodulation Distortion (IMD)	$G = +1$, $V_{OUT} = 3V_{RMS}$, SMPTE/DIN, Two-Tone, 4:1 (60Hz and 7kHz)		0.000015		%
			-136		dB
	$G = +1$, $V_{OUT} = 3V_{RMS}$, DIM 30, (3kHz square wave and 15kHz sine wave)		0.000032		%
			-130		dB
$G = +1$, $V_{OUT} = 3V_{RMS}$, CCIF Twin-Tone, (19kHz and 20kHz)		0.00013		%	
		-118		dB	
Frequency Response					
Gain-Bandwidth Product (GBP)	$G = +100$		45		MHz
	$G = +1$		16		
Slew Rate (SR)	$G = -1$		16		V/ μs
Full Power Bandwidth ⁽¹⁾	$V_{OUT} = 1V_{P-P}$		2		MHz
Overload Recovery Time	$G = -10$		500		ns
Channel Separation (Dual)	$f = 1\text{kHz}$		-140		dB

NOTE: 1. Full-Power Bandwidth = Slew Rate/($2\pi \times V_P$).

ELECTRICAL CHARACTERISTICS (continued)

(At $T_A = +25^\circ\text{C}$, $V_S = 4.5\text{V}$ to 36V or $V_S = \pm 2.25\text{V}$ to $\pm 18\text{V}$, $R_L = 2\text{k}\Omega$, $V_{CM} = V_{OUT} = V_S/2$, unless otherwise noted.)

PARAMETER	CONDITIONS	MIN	TYP	MAX	UNITS
Noise Performance					
Input Voltage Noise	$f = 20\text{Hz}$ to 20kHz		1.7		μV_{P-P}
Input Voltage Noise Density (e_n)	$f = 10\text{Hz}$		5		$\text{nV}/\sqrt{\text{Hz}}$
	$f = 100\text{Hz}$		2		
	$f = 1\text{kHz}$		1.6		
Input Current Noise Density (i_n)	$f = 1\text{kHz}$		6		$\text{pA}/\sqrt{\text{Hz}}$
Power Supply					
Supply Voltage (V_S)		± 1.8		± 18	V
Specified Voltage (V_S)		± 2.25		± 18	V
Quiescent Current/Amplifier (I_Q)	$V_S = 3.6\text{V}$ to 36V , $I_{OUT} = 0$		3.8	5	mA
	$-40^\circ\text{C} \leq T_A \leq +85^\circ\text{C}$			5.5	
Power Supply Rejection Ratio (PSRR)	$V_S = \pm 1.8\text{V}$ to $\pm 18\text{V}$		0.1	1	$\mu\text{V}/\text{V}$
	$-40^\circ\text{C} \leq T_A \leq +85^\circ\text{C}$			1.5	

TYPICAL PERFORMANCE CHARACTERISTICS

At $T_A = +25^\circ\text{C}$, $V_S = \pm 15\text{V}$ and $R_L = 2\text{k}\Omega$, unless otherwise noted.

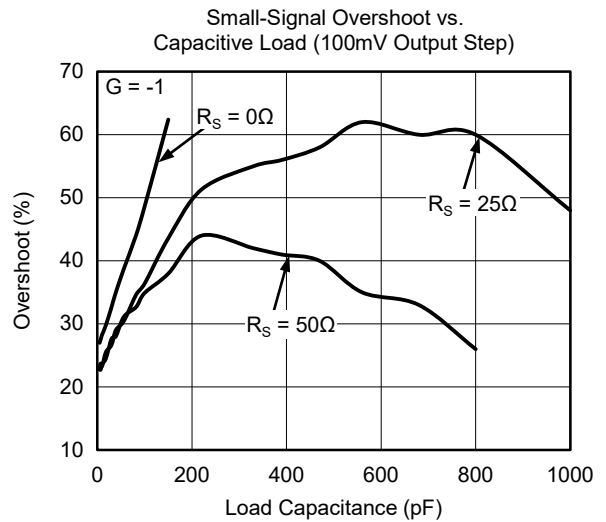
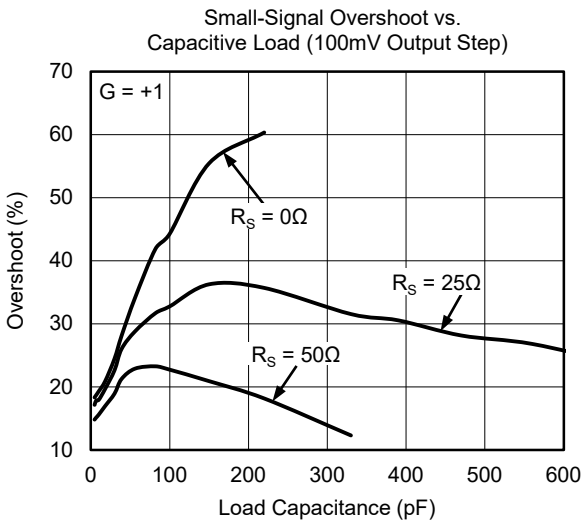
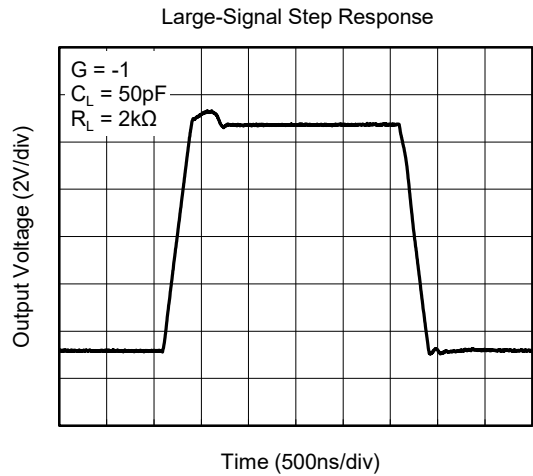
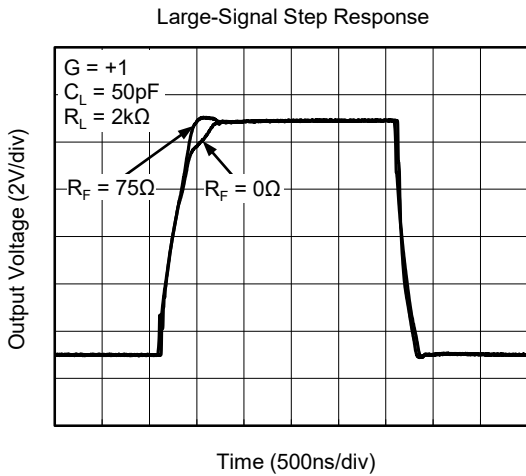
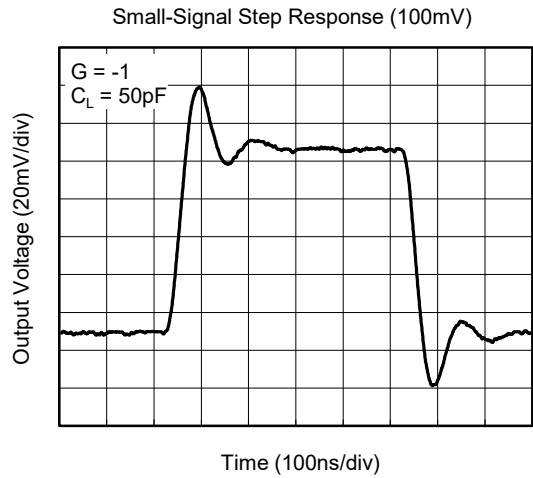
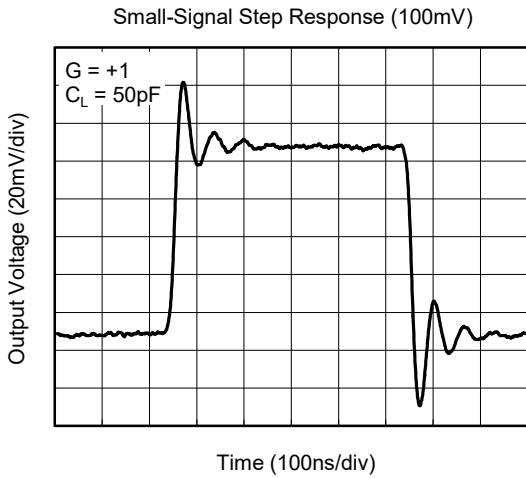

TYPICAL PERFORMANCE CHARACTERISTICS (continued)

At $T_A = +25^\circ\text{C}$, $V_S = \pm 15\text{V}$ and $R_L = 2\text{k}\Omega$, unless otherwise noted.

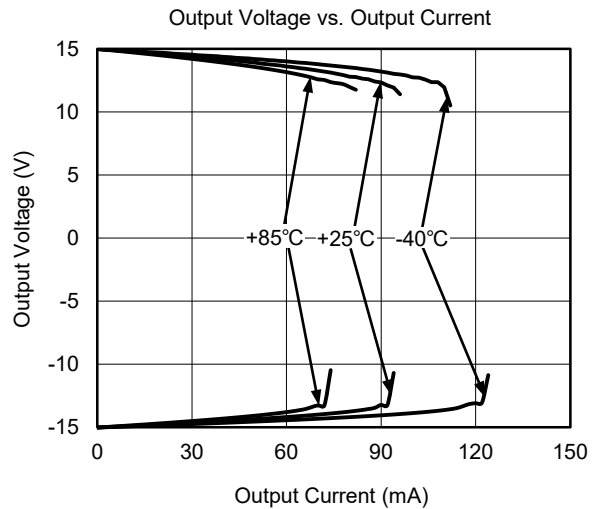
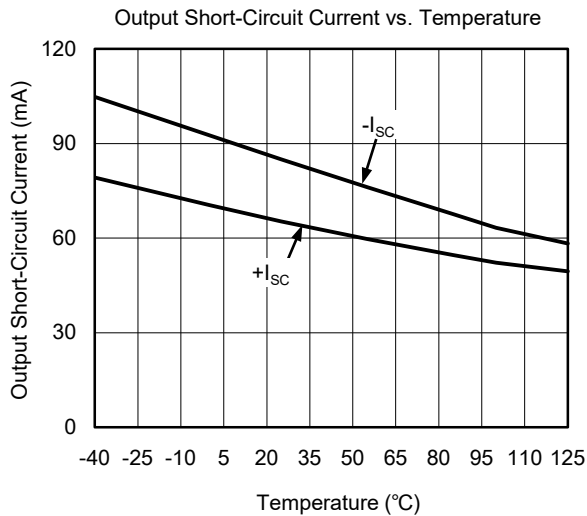
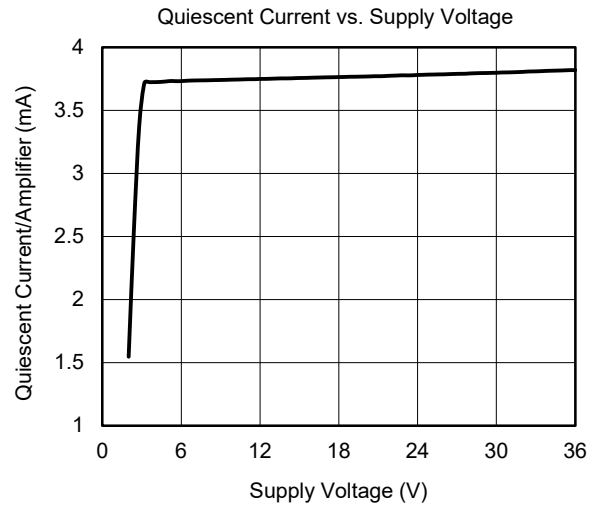
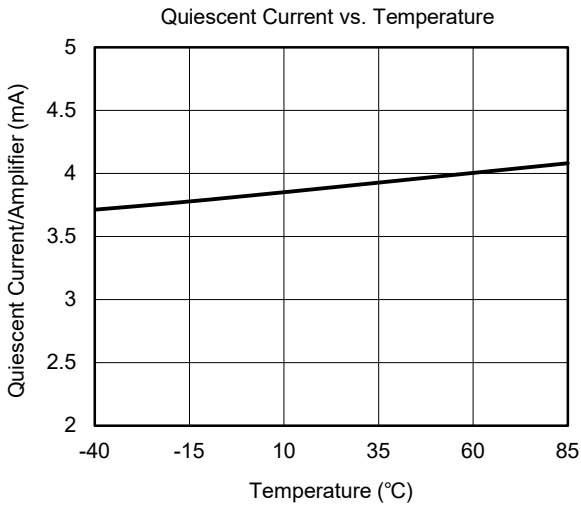
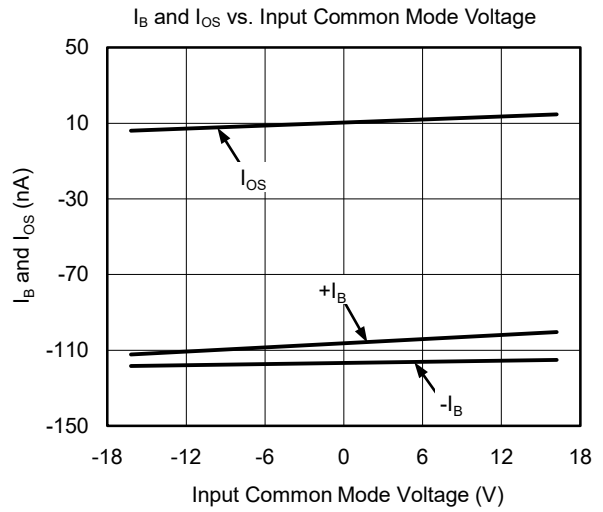
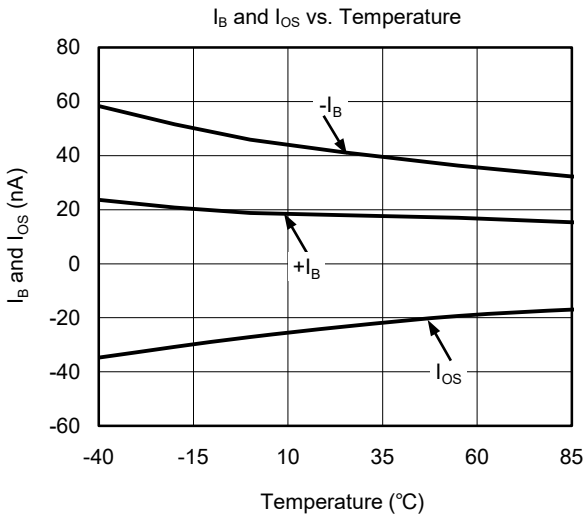

TYPICAL PERFORMANCE CHARACTERISTICS (continued)

At $T_A = +25^\circ\text{C}$, $V_S = \pm 15\text{V}$ and $R_L = 2\text{k}\Omega$, unless otherwise noted.

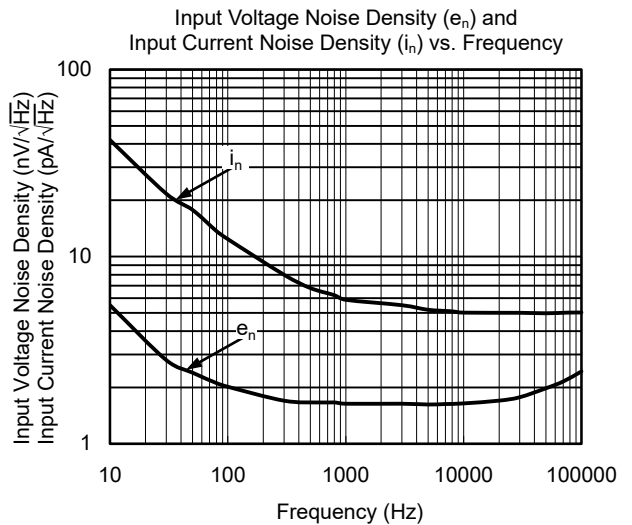
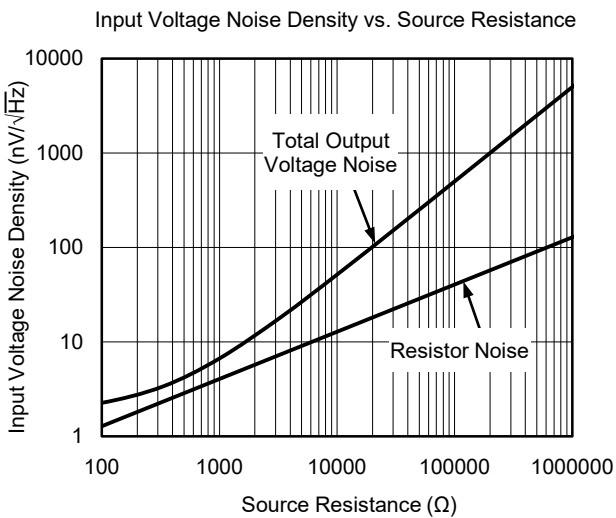
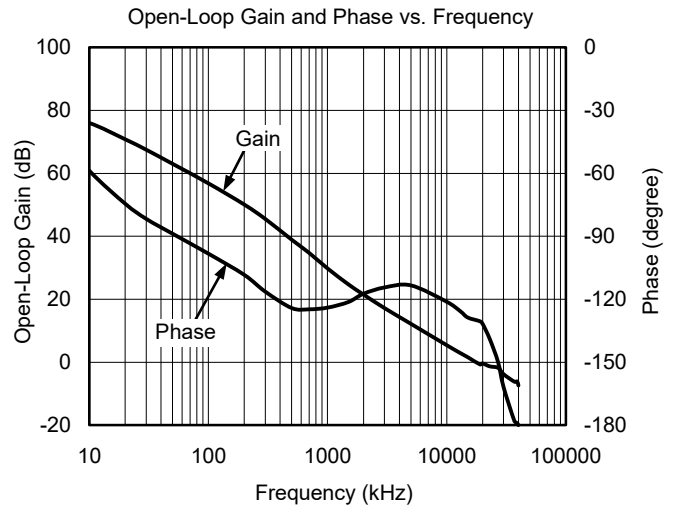
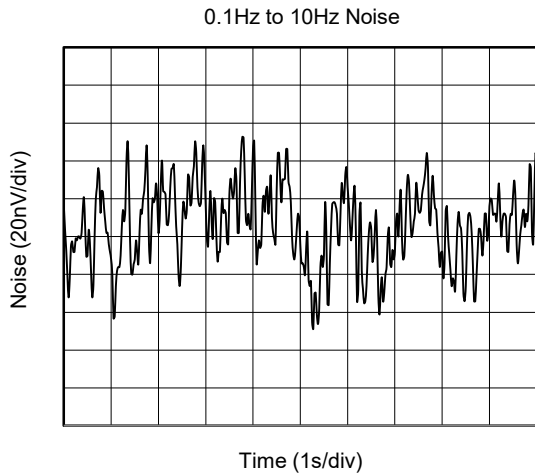
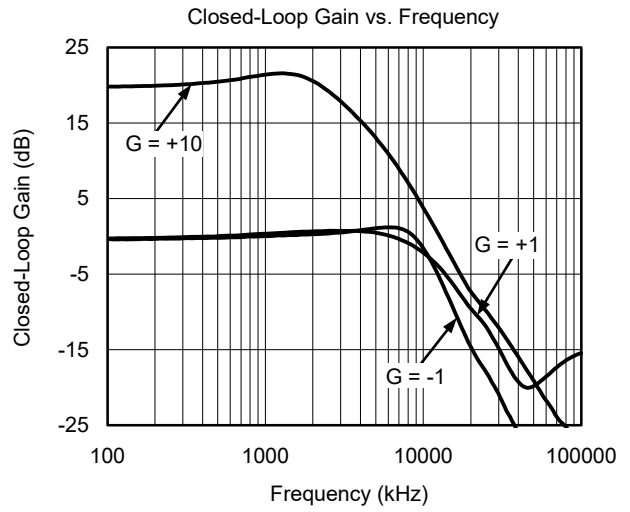
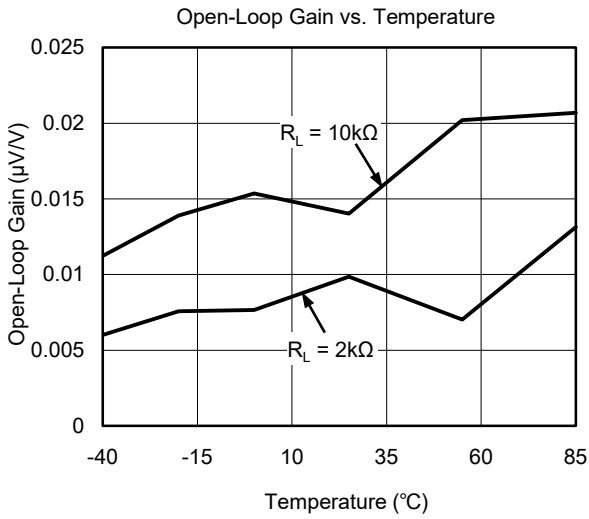

TYPICAL PERFORMANCE CHARACTERISTICS (continued)

At $T_A = +25^\circ\text{C}$, $V_S = \pm 15\text{V}$ and $R_L = 2\text{k}\Omega$, unless otherwise noted.

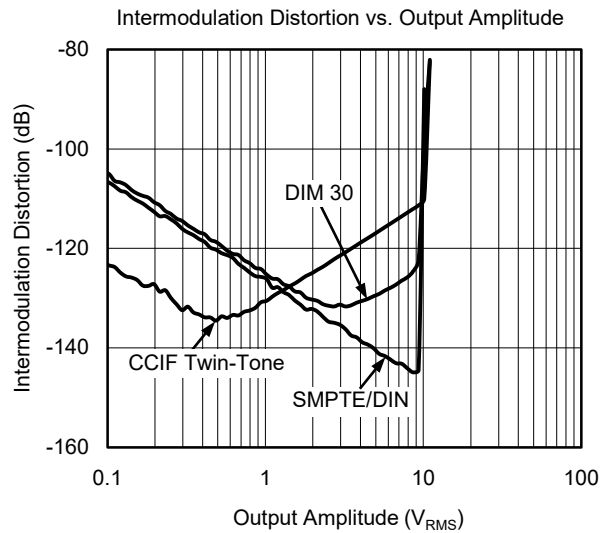
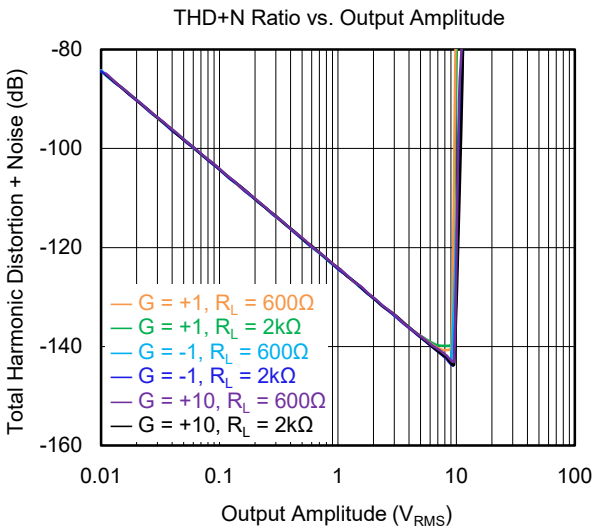
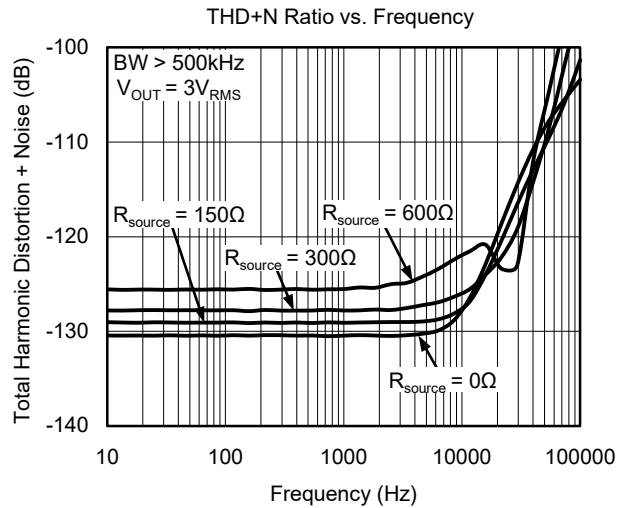
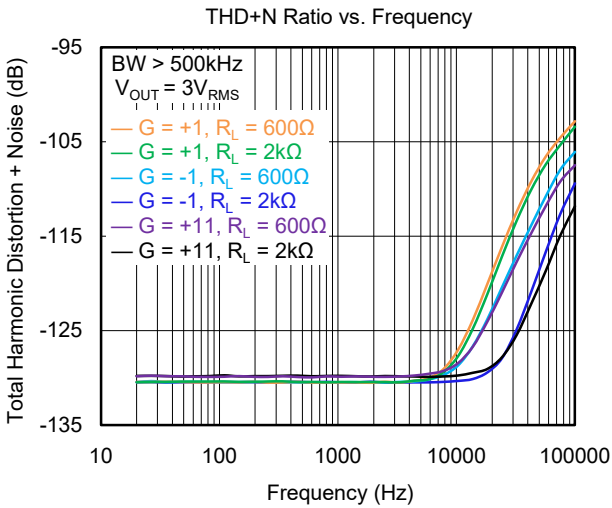
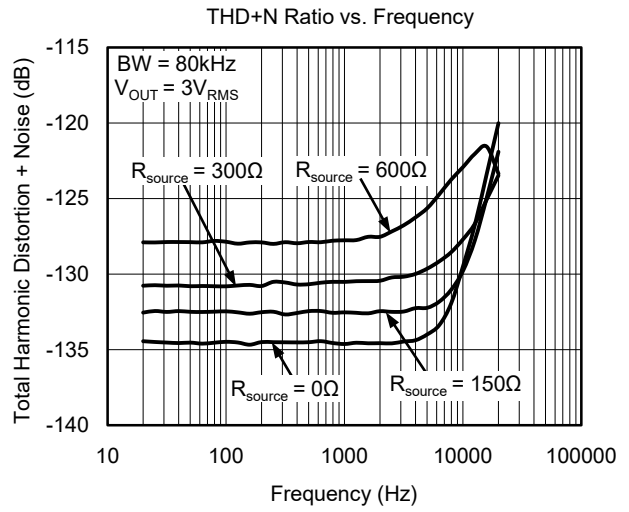
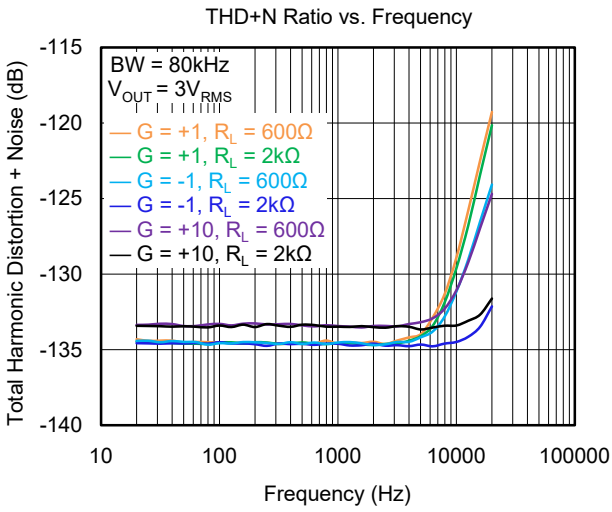

TYPICAL PERFORMANCE CHARACTERISTICS (continued)

At $T_A = +25^\circ\text{C}$, $V_S = \pm 15\text{V}$ and $R_L = 2\text{k}\Omega$, unless otherwise noted.

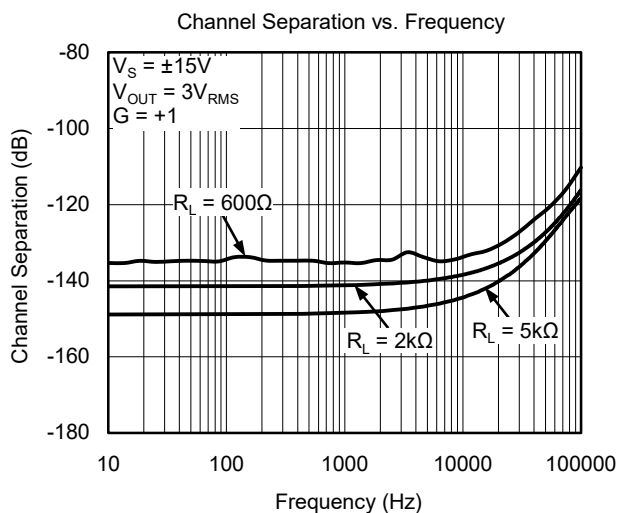
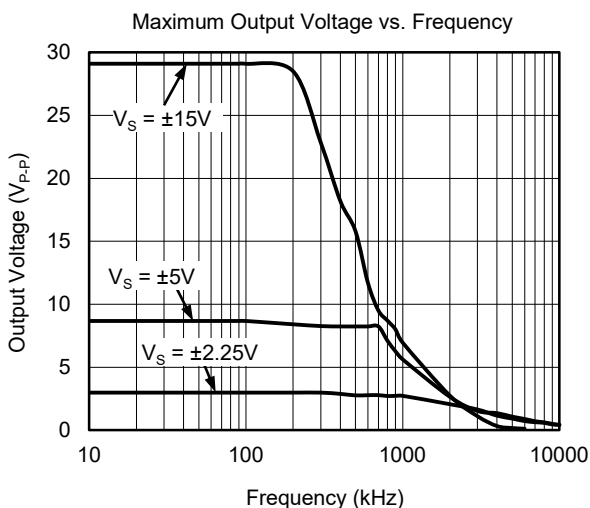
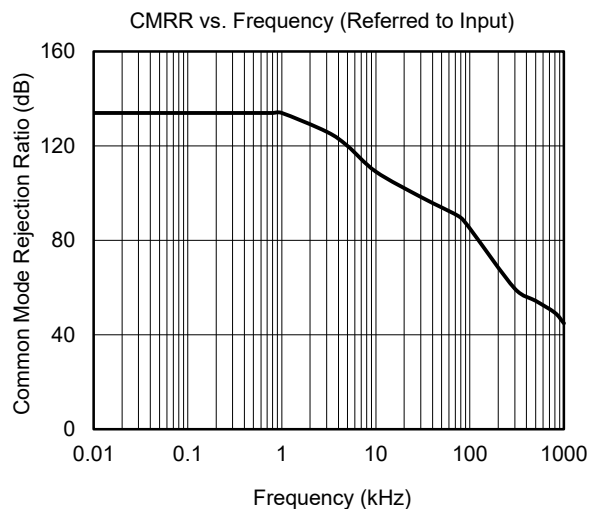
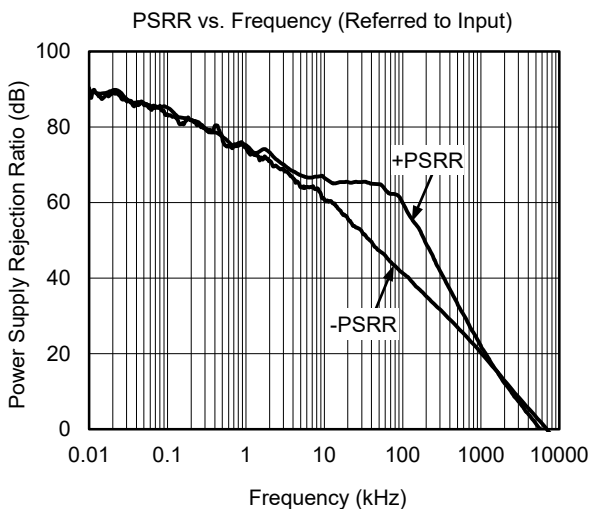

REVISION HISTORY

NOTE: Page numbers for previous revisions may differ from page numbers in the current version.

APRIL 2020 – REV.A.1 to REV.A.2	Page
Deleted TDFN-3×3-8AL Package	All
Updated Typical Performance Characteristics section	8, 9

MAY 2017 – REV.A to REV.A.1	Page
Changed supply voltage range	1

Changes from Original (MAY 2017) to REV.A	Page
Changed from product preview to production data.....	All

PACKAGE OUTLINE DIMENSIONS

SOIC-8

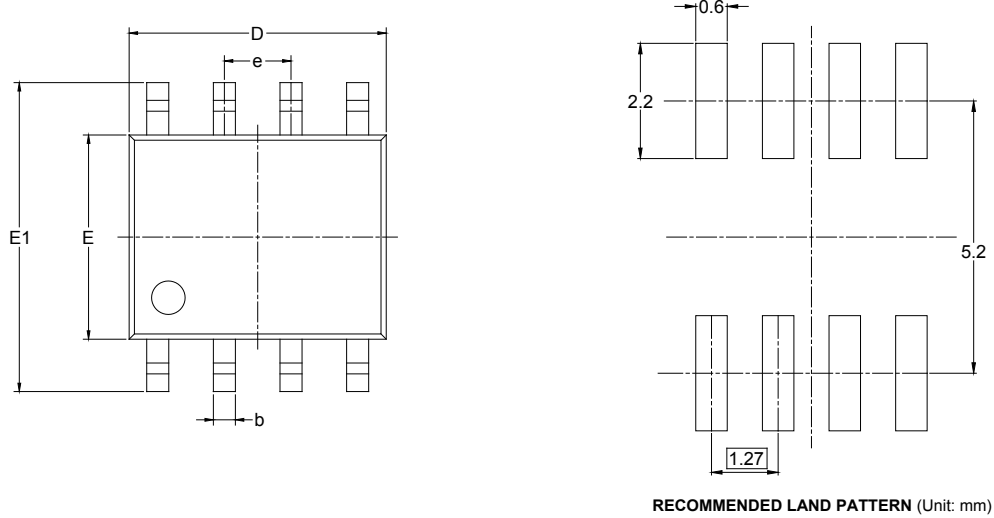

Symbol	Dimensions In Millimeters		Dimensions In Inches	
	MIN	MAX	MIN	MAX
A	1.350	1.750	0.053	0.069
A1	0.100	0.250	0.004	0.010
A2	1.350	1.550	0.053	0.061
b	0.330	0.510	0.013	0.020
c	0.170	0.250	0.006	0.010
D	4.700	5.100	0.185	0.200
E	3.800	4.000	0.150	0.157
E1	5.800	6.200	0.228	0.244
e	1.27 BSC		0.050 BSC	
L	0.400	1.270	0.016	0.050
θ	0°	8°	0°	8°

PACKAGE OUTLINE DIMENSIONS

MSOP-8

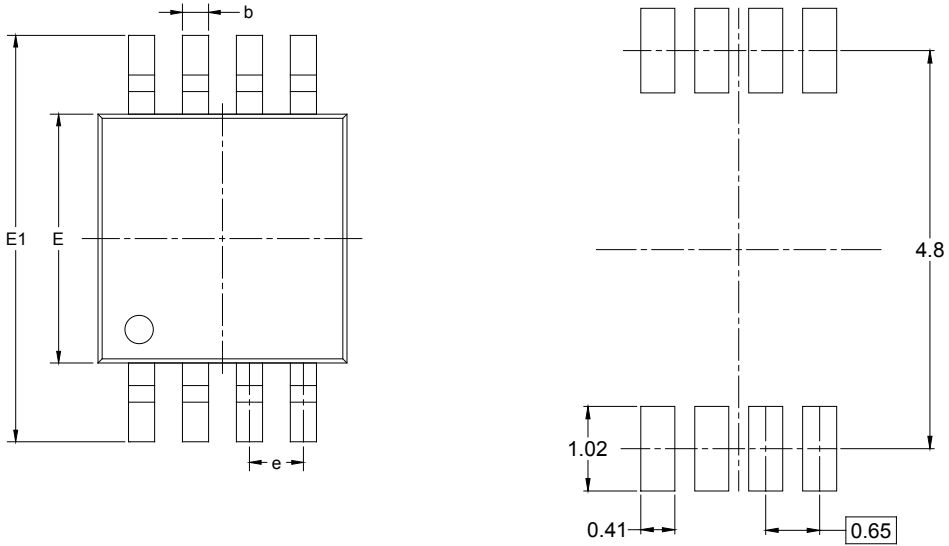

RECOMMENDED LAND PATTERN (Unit: mm)

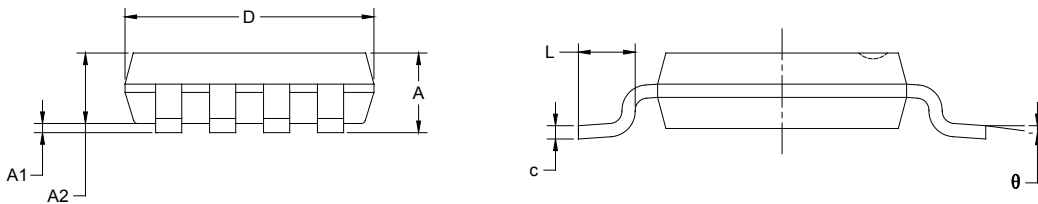

Symbol	Dimensions In Millimeters		Dimensions In Inches	
	MIN	MAX	MIN	MAX
A	0.820	1.100	0.032	0.043
A1	0.020	0.150	0.001	0.006
A2	0.750	0.950	0.030	0.037
b	0.250	0.380	0.010	0.015
c	0.090	0.230	0.004	0.009
D	2.900	3.100	0.114	0.122
E	2.900	3.100	0.114	0.122
E1	4.750	5.050	0.187	0.199
e	0.650 BSC		0.026 BSC	
L	0.400	0.800	0.016	0.031
θ	0°	6°	0°	6°

PACKAGE OUTLINE DIMENSIONS

TDFN-3x3-8BL

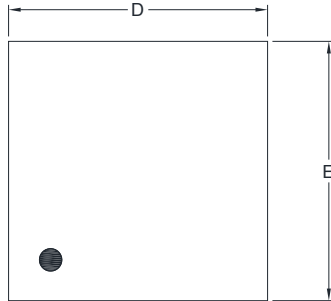

TOP VIEW

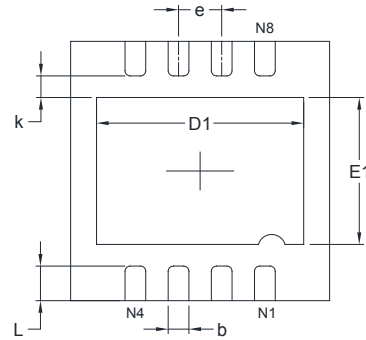

BOTTOM VIEW

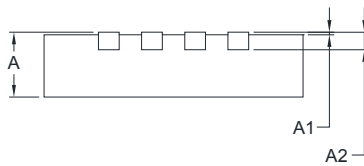

SIDE VIEW

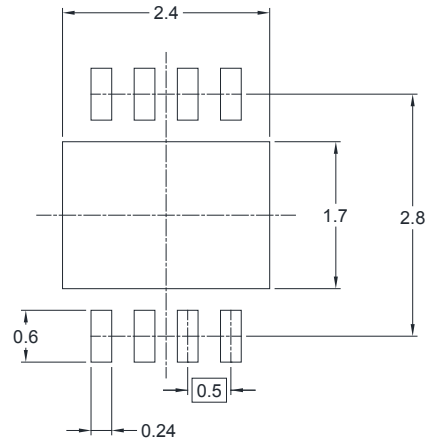

RECOMMENDED LAND PATTERN (Unit: mm)

Symbol	Dimensions In Millimeters		Dimensions In Inches	
	MIN	MAX	MIN	MAX
A	0.700	0.800	0.028	0.031
A1	0.000	0.050	0.000	0.002
A2	0.203 REF		0.008 REF	
D	2.900	3.100	0.114	0.122
D1	2.300	2.500	0.091	0.098
E	2.900	3.100	0.114	0.122
E1	1.600	1.800	0.063	0.071
k	0.200 MIN		0.008 MIN	
b	0.180	0.300	0.007	0.012
e	0.500 TYP		0.020 TYP	
L	0.300	0.500	0.012	0.020

PACKAGE INFORMATION

TAPE AND REEL INFORMATION

REEL DIMENSIONS



TAPE DIMENSIONS



NOTE: The picture is only for reference. Please make the object as the standard.

KEY PARAMETER LIST OF TAPE AND REEL

Package Type	Reel Diameter	Reel Width W1 (mm)	A0 (mm)	B0 (mm)	K0 (mm)	P0 (mm)	P1 (mm)	P2 (mm)	W (mm)	Pin1 Quadrant
SOIC-8	13"	12.4	6.40	5.40	2.10	4.0	8.0	2.0	12.0	Q1
MSOP-8	13"	12.4	5.20	3.30	1.50	4.0	8.0	2.0	12.0	Q1
TDFN-3×3-8BL	13"	12.4	3.35	3.35	1.13	4.0	8.0	2.0	12.0	Q1

DD0001

PACKAGE INFORMATION

CARTON BOX DIMENSIONS



NOTE: The picture is only for reference. Please make the object as the standard.

KEY PARAMETER LIST OF CARTON BOX

Reel Type	Length (mm)	Width (mm)	Height (mm)	Pizza/Carton
13"	386	280	370	5

DD0002