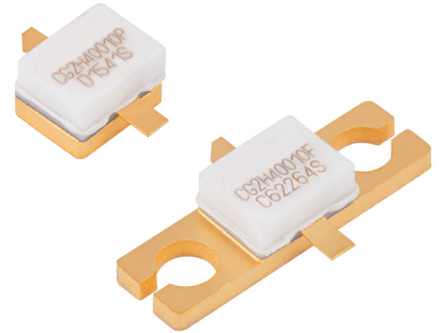


# CG2H40010

10 W, DC - 8 GHz, RF Power GaN HEMT

## Description

The CG2H40010 is an unmatched, gallium nitride (GaN) high electron mobility transistor (HEMT). The CG2H40010, operating from a 28 volt rail, offers a general purpose, broadband solution to a variety of RF and microwave applications. GaN HEMTs offer high efficiency, high gain and wide bandwidth capabilities making the CG2H40010 ideal for linear and compressed amplifier circuits. The transistor is available in both screw-down, flange and solderdown, pill packages.



Package Types: 440196, & 440166  
PNs: CG2H40010P & CG2H40010F

## Features

- Up to 8 GHz Operation
- 18 dB Small Signal Gain at 2.0 GHz
- 16 dB Small Signal Gain at 4.0 GHz
- 17 W typical  $P_{SAT}$
- 70% Efficiency at  $P_{SAT}$
- 28 V Operation

## Applications

- 2-Way Private Radio
- Broadband Amplifiers
- Cellular Infrastructure
- Test Instrumentation
- Class A, AB, Linear amplifiers suitable for OFDM, W-CDMA, EDGE, CDMA waveforms



**Large Signal Models Available for ADS and MWO**



### Absolute Maximum Ratings (not simultaneous) at 25°C Case Temperature

Parameter	Symbol	Rating	Units	Conditions
Drain-Source Voltage	$V_{DSS}$	120	V	25°C
Gate-to-Source Voltage	$V_{GS}$	-10, +2		
Storage Temperature	$T_{STG}$	-65, +150	°C	
Operating Junction Temperature	$T_J$	225		
Maximum Forward Gate Current	$I_{GMAX}$	4.0	mA	25°C
Maximum Drain Current <sup>1</sup>	$I_{DMAX}$	1.5	A	
Soldering Temperature <sup>2</sup>	$T_S$	245	°C	
Screw Torque	$\tau$	40	in-oz	
Thermal Resistance, Junction to Case <sup>3</sup>	$R_{\theta JC}$	7.83	°C/W	85°C
Case Operating Temperature <sup>3,4</sup>	$T_C$	-40, +150	°C	

## Notes:

<sup>1</sup> Current limit for long term, reliable operation<sup>2</sup> Refer to the Application Note on soldering<sup>3</sup> Measured for the CG2H40010F at  $P_{DISS} = 14$  W<sup>4</sup> See also, the Power Dissipation De-rating Curve on Page 6

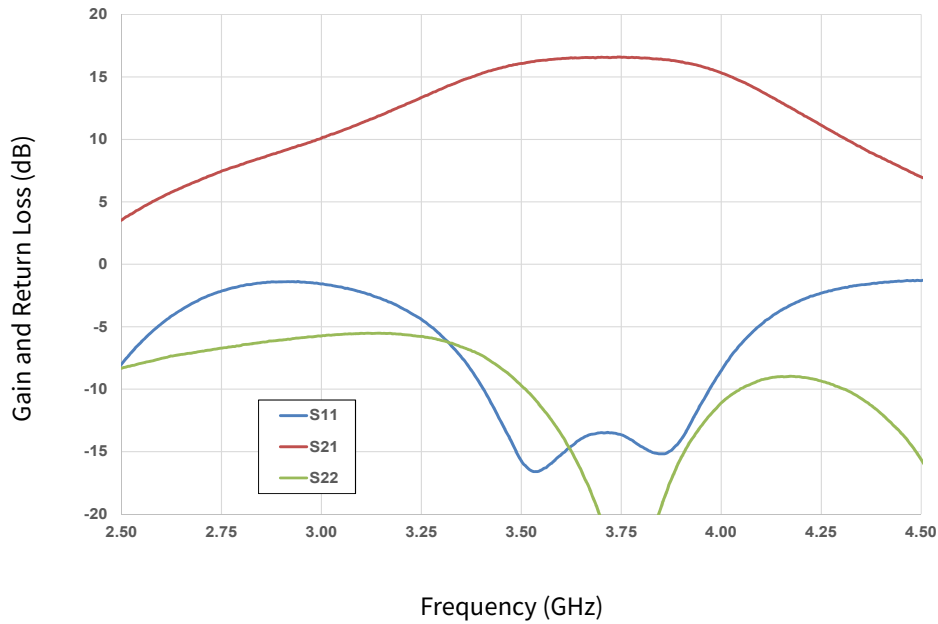
### Electrical Characteristics ( $T_C = 25^\circ\text{C}$ )

Parameter	Symbol	Min.	Typ.	Max.	Units	Conditions
<b>DC Characteristics<sup>1</sup></b>						
Gate Threshold Voltage	$V_{GS(th)}$	-3.6	-3.0	-2.4	$V_{DC}$	$V_{DS} = 10$ V, $I_D = 3.6$ mA
Gate Quiescent Voltage	$V_{GS(Q)}$	—	-2.7	—		$V_{DS} = 28$ V, $I_D = 200$ mA
Saturated Drain Current	$I_{DS}$	2.59	3.6	—	A	$V_{DS} = 6.0$ V, $V_{GS} = 2.0$ V
Drain-Source Breakdown Voltage	$V_{BR}$	84	—	—	$V_{DC}$	$V_{GS} = -8$ V, $I_D = 3.6$ mA
<b>RF Characteristics<sup>2</sup> (<math>T_C = 25^\circ\text{C}</math>, <math>F_0 = 3.7</math> GHz unless otherwise noted)</b>						
Small Signal Gain	$G_{SS}$	15.0	16.7	—	dB	$V_{DD} = 28$ V, $I_{DQ} = 200$ mA
Output Power <sup>3</sup>	$P_{SAT}$	11.0	16.5	—	W	
Drain Efficiency <sup>4</sup>	$\eta$	60	70	—	%	$V_{DD} = 28$ V, $I_{DQ} = 200$ mA, $P_{SAT}$
Output Mismatch Stress	VSWR	—	—	10 : 1	Y	No damage at all phase angles, $V_{DD} = 28$ V, $I_{DQ} = 200$ mA, $P_{OUT} = 10$ W CW
<b>Dynamic Characteristics</b>						
Input Capacitance	$C_{GS}$	—	4.19	—	pF	$V_{DS} = 28$ V, $V_{GS} = -8$ V, $f = 1$ MHz
Output Capacitance	$C_{DS}$	—	1.84	—		
Feedback Capacitance	$C_{GD}$	—	0.186	—		

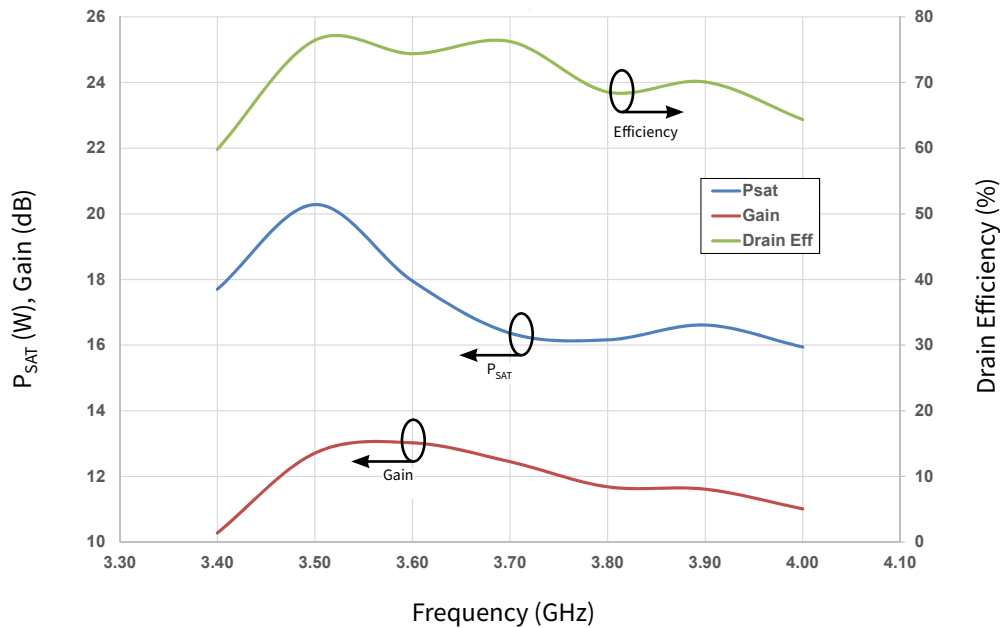
## Notes:

<sup>1</sup> Measured on wafer prior to packaging<sup>2</sup> Measured in CG2H40010-AMP<sup>3</sup>  $P_{SAT}$  is defined as  $I_G = 0.36$  mA<sup>4</sup> Drain Efficiency =  $P_{OUT} / P_{DC}$

Typical Performance

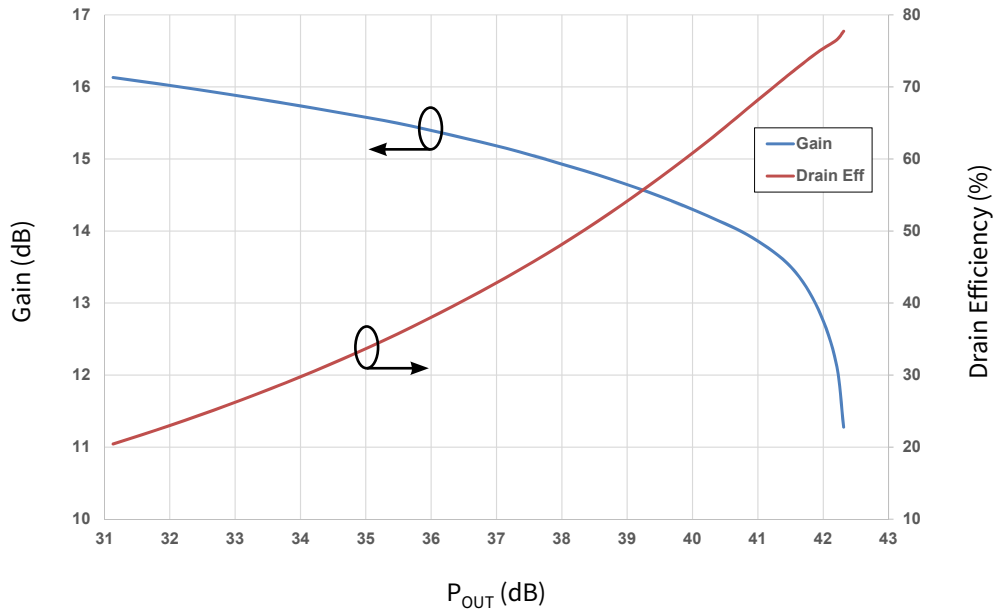


**Figure 1.** Small Signal Gain and Return Loss vs Frequency of the CG2H40010F in the CG2H40010-AMP  
 $V_{DD} = 28\text{ V}$ ,  $I_{DQ} = 100\text{ mA}$

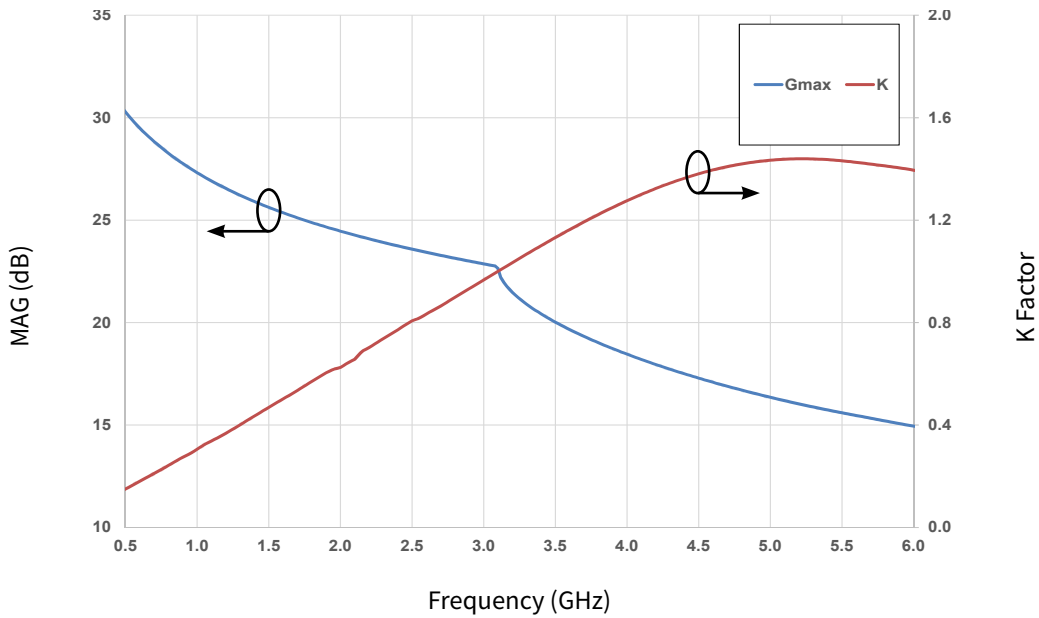


**Figure 2.**  $P_{SAT}$ , Gain, and Drain Efficiency vs Frequency of the CG2H40010F in the CG2H40010-AMP  
 $V_{DD} = 28\text{ V}$ ,  $I_{DQ} = 100\text{ mA}$

Typical Performance

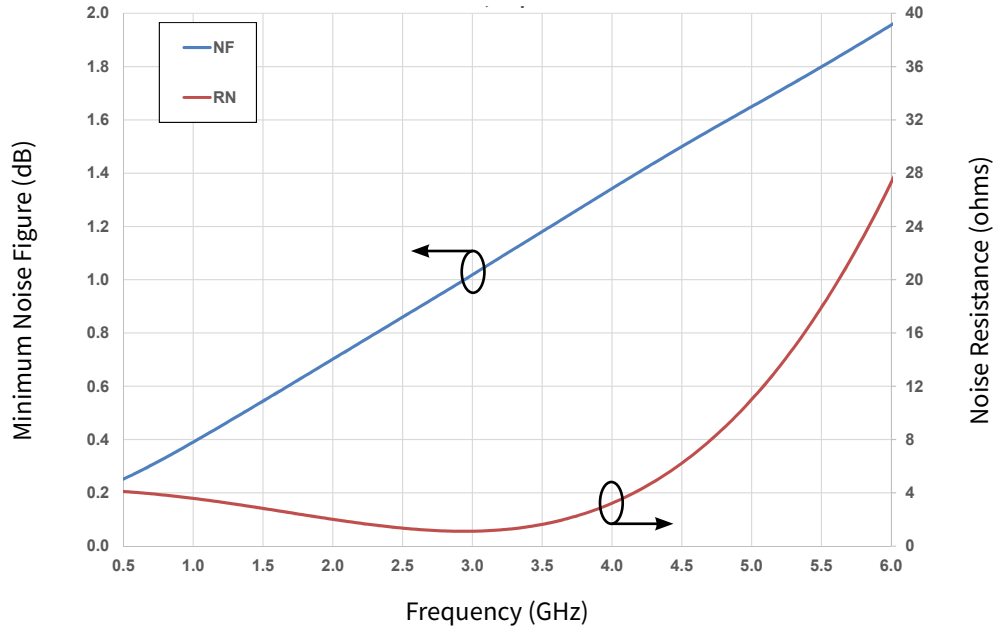


**Figure 3.** Swept CW Data of CG2H40010F vs. Output Power Measured in CG2H40010-AMP at 3.7 GHz  
 $V_{DD} = 28\text{ V}$ ,  $I_{DQ} = 100\text{ mA}$



**Figure 4.** Simulated Maximum Available Gain and K Factor of CG2H40010F  
 $V_{DD} = 28\text{ V}$ ,  $I_{DQ} = 100\text{ mA}$

## Typical Noise Performance

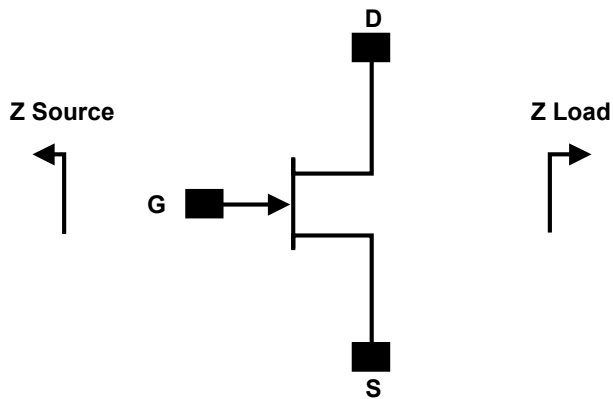


**Figure 5.** Simulated Minimum Noise Figure and Noise Resistance vs Frequency of the CG2H40010F  
 $V_{DD} = 28\text{ V}$ ,  $I_{DQ} = 100\text{ mA}$

## Electrostatic Discharge (ESD) Classifications

Parameter	Symbol	Class	Classification Level	Test Methodology
Human Body Model	HBM	2	ANSI/ESDA/JEDEC JS-001 Table 3	JEDEC JESD22 A114-D
Charge Device Model	CDM	C3	ANSI/ESDA/JEDEC JS-002 Table 3	JEDEC JESD22 C101-C

## Source and Load Impedances



Frequency (MHz)	Z Source	Z Load
0.50	55.3 + j27.6	40.9 + j2.34
1.00	30.9 + j17.8	26 + j7.7
1.50	20.4 + j5.17	27 + j6.5
2.00	16.7 + j0.60	18.3 + j5.94
2.50	9.7 - j4.6	11.5 + j10.9
3.00	6.6 - j7.75	20.6 + j8.75
3.50	5.1 - j11.5	15.2 + j3.43
4.00	6.21 - j14.1	11.6 - j4.77
4.50	4.89 - j19.8	8.58 - j5.11
5.00	5.22 - j25.9	10.8 - j6.23
5.50	5.77 - j30.8	9.06 - j13.3
6.00	8.04 - j37.2	10.2 - j15.3

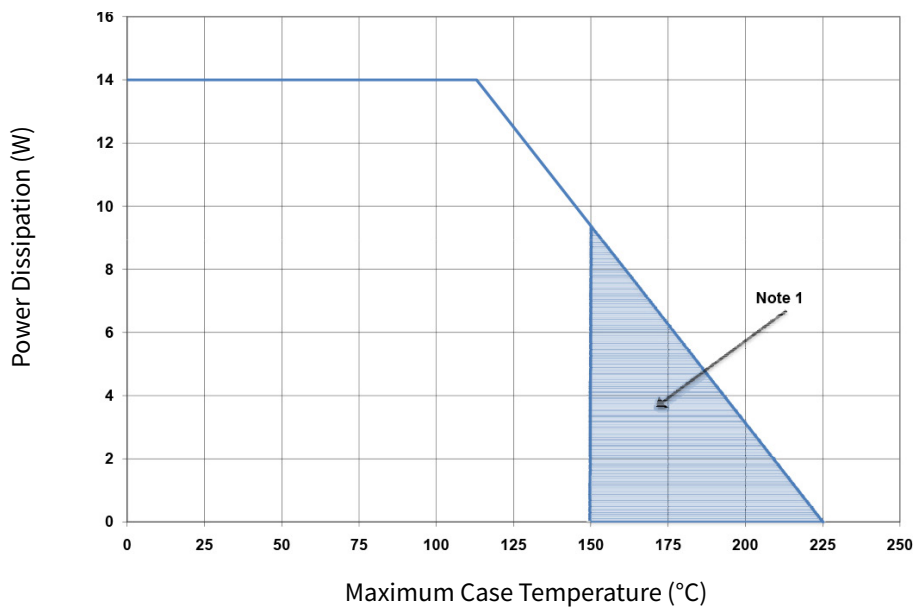
### Notes:

<sup>1</sup>  $V_{DD} = 28V$ ,  $I_{DQ} = 100$  mA in the 440166 package

<sup>2</sup> Optimized for power, gain,  $P_{SAT}$  and PAE

<sup>3</sup> When using this device at low frequency, series resistors should be used to maintain amplifier stability

## CG2H40010 Power Dissipation De-rating Curve



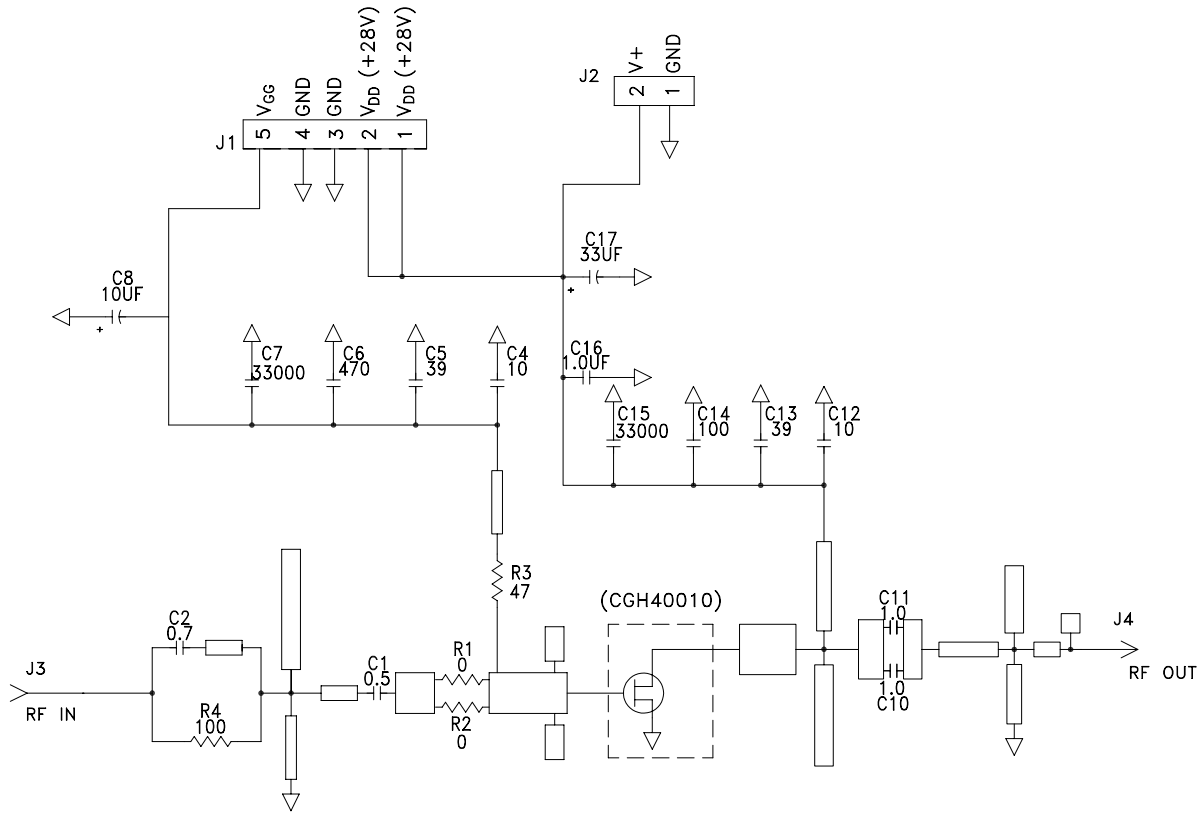
### Note:

<sup>1</sup> Area exceeds Maximum Case Operating Temperature (See Page 2)

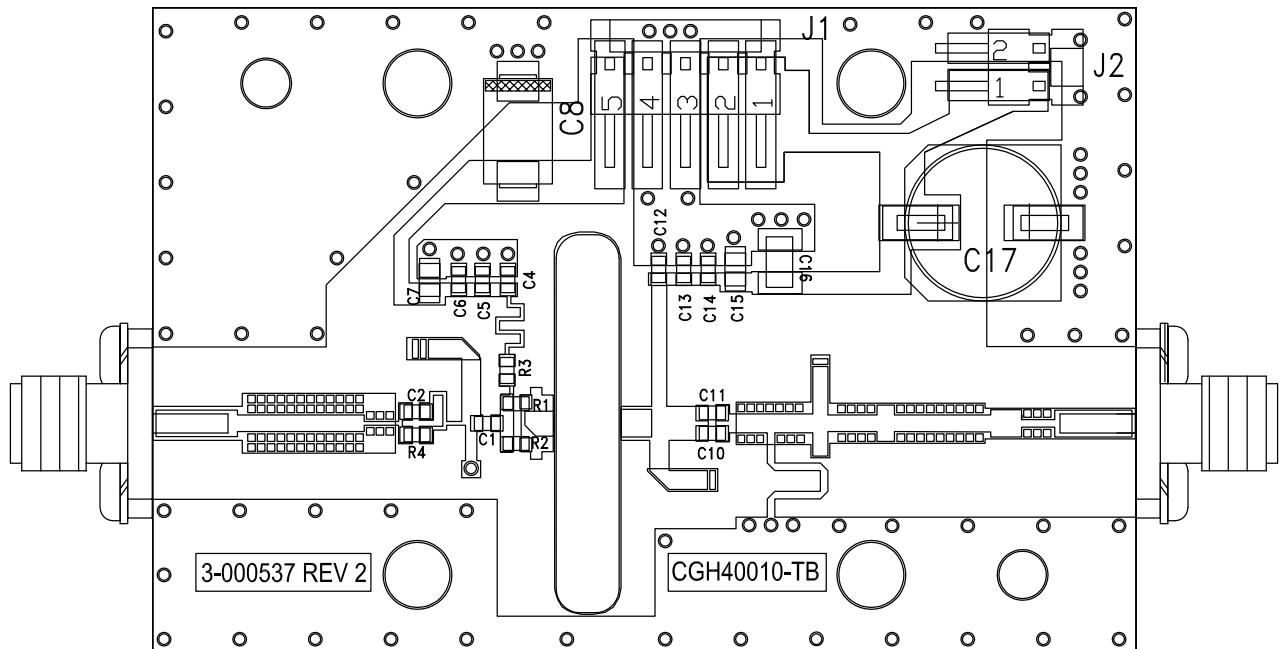
**CG2H40010-AMP Demonstration Amplifier Circuit Bill of Materials**

Designator	Description	Qty
R1, R2	RES, 1/16W, 0603, 1%,0 ohms	1
R3	RES, 1/16W, 0603, 1%,47 ohms	1
R4	RES, 1/16W, 0603, 1%,100 ohms	1
C6	CAP, 470pF, 5%, 100V, 0603, X7R, RoHS COMPLIANT	1
C17	CAP, 33μF, 20%, G CASE	1
C16	CAP, 1.μF, 100V, 10%, X7R, 1210	1
C8	CAP, 10μF, 16V, TANTALUM	1
C14	CAP, 100.0pF, +/-5%, 0603	1
C1	CAP, 0.5pF, +/-0.05pF, 0603	1
C2	CAP, 0.7pF, +/-0.1pF, 0603	1
C10, C11	CAP, 1.0pF, +/-0.1pF, 0603	2
C4, C12	CAP, 10.0pF, +/-5%, 0603	2
C5, C13	CAP, 39pF, +/-5%, 0603	2
C7, C15	CAP, 33000PF, 0805,100V, X7R	2
J3, J4	CONN, SMA, STR PANEL, JACK RECP	1
J2	HEADER RT>PLZ .1CEN LK 2 POS	1
J1	HEADER RT>PLZ .1CEN LK 5POS	1
-	PCB, RO4350B, Er = 3.48, h = 20 mil	1
Q1	CG2H40010F or CG2H40010P	1

**CG2H40010-AMP Demonstration Amplifier Circuit Schematic**



**CG2H40010-AMP Demonstration Amplifier Circuit Outline**





**Typical Package S-Parameters for CG2H40010**  
**(Small Signal,  $V_{DS} = 28\text{ V}$ ,  $I_{DQ} = 100\text{ mA}$ , angle in degrees)**

Frequency	Mag S11	Ang S11	Mag S21	Ang S21	Mag S12	Ang S12	Mag S22	Ang S22
0.50	0.872	-116.75	21.365	110.57	0.0279	24.89	0.417	-103.52
0.60	0.860	-126.97	18.584	103.99	0.0290	19.19	0.407	-112.55
0.70	0.851	-135.13	16.376	98.45	0.0298	14.53	0.401	-119.61
0.80	0.845	-141.80	14.600	93.64	0.0302	10.60	0.398	-125.24
0.90	0.841	-147.38	13.151	89.35	0.0306	7.22	0.397	-129.81
1.00	0.837	-152.15	11.950	85.47	0.0307	4.24	0.398	-133.60
1.10	0.835	-156.31	10.942	81.88	0.0308	1.56	0.399	-136.79
1.20	0.833	-159.98	10.086	78.52	0.0309	-0.87	0.402	-139.53
1.30	0.831	-163.28	9.350	75.34	0.0309	-3.10	0.405	-141.92
1.40	0.830	-166.28	8.712	72.32	0.0308	-5.17	0.409	-144.05
1.50	0.829	-169.04	8.155	69.41	0.0307	-7.11	0.413	-145.96
1.60	0.829	-171.60	7.663	66.61	0.0306	-8.93	0.417	-147.72
1.70	0.828	-174.01	7.227	63.89	0.0305	-10.65	0.422	-149.34
1.80	0.828	-176.27	6.838	61.24	0.0304	-12.28	0.427	-150.87
1.90	0.827	-178.43	6.488	58.65	0.0302	-13.82	0.432	-152.32
2.00	0.827	179.50	6.173	56.11	0.0300	-15.29	0.437	-153.71
2.10	0.827	177.51	5.888	53.62	0.0299	-16.70	0.442	-155.05
2.20	0.826	175.58	5.628	51.17	0.0297	-18.03	0.447	-156.36
2.30	0.826	173.70	5.391	48.76	0.0295	-19.31	0.453	-157.64
2.40	0.826	171.87	5.174	46.38	0.0293	-20.52	0.458	-158.90
2.50	0.825	170.07	4.975	44.02	0.0291	-21.68	0.463	-160.15
2.60	0.825	168.30	4.791	41.69	0.0288	-22.78	0.468	-161.38
2.70	0.825	166.56	4.622	39.37	0.0286	-23.83	0.473	-162.61
2.80	0.824	164.83	4.465	37.08	0.0284	-24.82	0.478	-163.84
2.90	0.824	163.12	4.320	34.80	0.0282	-25.76	0.483	-165.07
3.00	0.824	161.41	4.185	32.54	0.0280	-26.64	0.488	-166.31
3.20	0.823	158.01	3.941	28.06	0.0276	-28.24	0.496	-168.79
3.40	0.821	154.60	3.730	23.61	0.0272	-29.61	0.505	-171.31
3.60	0.820	151.17	3.545	19.19	0.0268	-30.76	0.512	-173.86
3.80	0.818	147.68	3.382	14.76	0.0265	-31.70	0.519	-176.46
4.00	0.816	144.13	3.239	10.34	0.0262	-32.41	0.525	-179.10
4.20	0.814	140.49	3.113	5.89	0.0260	-32.91	0.531	178.20
4.40	0.811	136.74	3.002	1.42	0.0259	-33.20	0.535	175.44
4.60	0.809	132.85	2.905	-3.10	0.0259	-33.31	0.539	172.61
4.80	0.806	128.81	2.821	-7.68	0.0261	-33.28	0.542	169.69
5.00	0.802	124.60	2.746	-12.33	0.0264	-33.14	0.544	166.67
5.20	0.799	120.21	2.680	-17.05	0.0269	-32.94	0.545	163.54
5.40	0.795	115.62	2.622	-21.86	0.0276	-32.76	0.545	160.28
5.60	0.791	110.82	2.569	-26.77	0.0286	-32.65	0.544	156.88
5.80	0.787	105.80	2.522	-31.78	0.0297	-32.69	0.542	153.33
6.00	0.783	100.56	2.479	-36.91	0.0311	-32.95	0.540	149.60

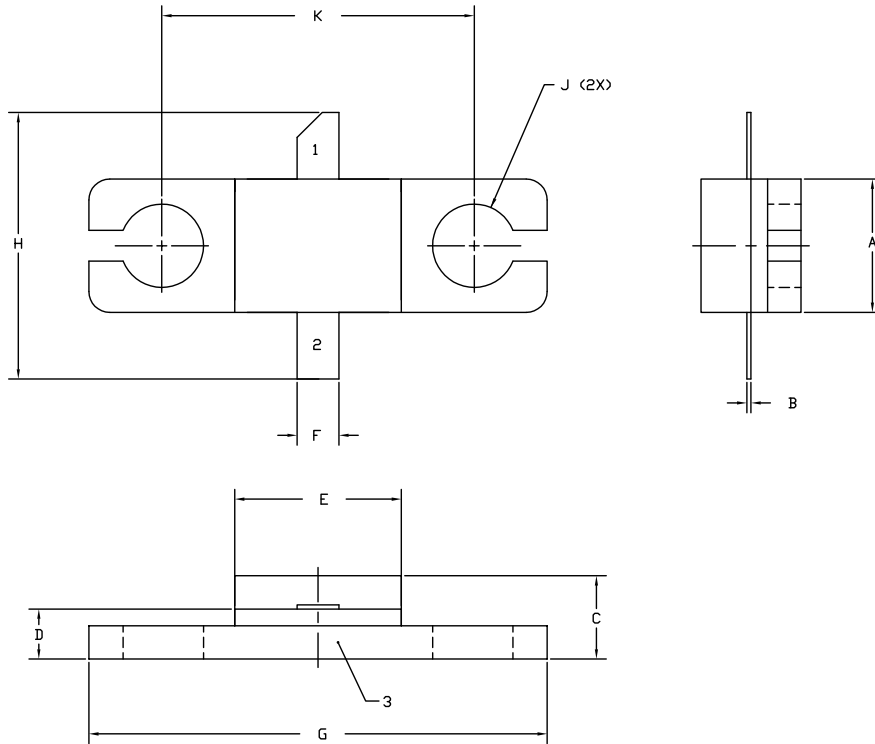
**Typical Package S-Parameters for CG2H40010**  
 (Small Signal,  $V_{DS} = 28\text{ V}$ ,  $I_{DQ} = 200\text{ mA}$ , angle in degrees)

Frequency	Mag S11	Ang S11	Mag S21	Ang S21	Mag S12	Ang S12	Mag S22	Ang S22
0.50	0.874	-125.62	23.065	107.16	0.0231	22.83	0.390	-121.46
0.60	0.865	-135.15	19.881	101.04	0.0238	17.87	0.389	-129.56
0.70	0.858	-142.64	17.413	95.93	0.0243	13.91	0.390	-135.68
0.80	0.853	-148.74	15.461	91.50	0.0246	10.65	0.391	-140.43
0.90	0.850	-153.82	13.887	87.55	0.0248	7.88	0.393	-144.22
1.00	0.848	-158.16	12.595	83.95	0.0249	5.47	0.395	-147.32
1.10	0.846	-161.95	11.518	80.62	0.0250	3.34	0.397	-149.92
1.20	0.844	-165.32	10.608	77.50	0.0250	1.43	0.400	-152.13
1.30	0.843	-168.35	9.830	74.53	0.0251	-0.30	0.403	-154.05
1.40	0.842	-171.12	9.158	71.70	0.0250	-1.89	0.406	-155.75
1.50	0.841	-173.68	8.572	68.96	0.0250	-3.36	0.410	-157.29
1.60	0.840	-176.06	8.057	66.32	0.0250	-4.72	0.413	-158.68
1.70	0.839	-178.31	7.600	63.74	0.0249	-5.99	0.417	-159.98
1.80	0.839	179.55	7.194	61.23	0.0249	-7.17	0.420	-161.20
1.90	0.838	177.51	6.830	58.76	0.0248	-8.29	0.424	-162.36
2.00	0.838	175.55	6.502	56.34	0.0247	-9.33	0.428	-163.47
2.10	0.837	173.65	6.206	53.96	0.0247	-10.31	0.432	-164.54
2.20	0.836	171.80	5.936	51.60	0.0246	-11.23	0.436	-165.60
2.30	0.836	170.00	5.690	49.28	0.0245	-12.10	0.440	-166.63
2.40	0.835	168.24	5.466	46.98	0.0244	-12.91	0.444	-167.65
2.50	0.835	166.50	5.259	44.70	0.0244	-13.66	0.447	-168.67
2.60	0.834	164.79	5.070	42.43	0.0243	-14.37	0.451	-169.68
2.70	0.833	163.09	4.894	40.19	0.0242	-15.02	0.455	-170.70
2.80	0.832	161.41	4.732	37.95	0.0242	-15.63	0.459	-171.72
2.90	0.832	159.73	4.582	35.73	0.0241	-16.19	0.462	-172.74
3.00	0.831	158.06	4.443	33.52	0.0241	-16.70	0.466	-173.78
3.20	0.829	154.72	4.192	29.12	0.0241	-17.58	0.472	-175.88
3.40	0.827	151.37	3.974	24.74	0.0241	-18.30	0.478	-178.04
3.60	0.825	147.98	3.783	20.37	0.0241	-18.86	0.484	179.75
3.80	0.822	144.53	3.615	15.99	0.0243	-19.28	0.489	177.48
4.00	0.820	141.00	3.467	11.59	0.0245	-19.59	0.493	175.13
4.20	0.817	137.38	3.337	7.16	0.0248	-19.82	0.497	172.72
4.40	0.813	133.65	3.223	2.69	0.0253	-20.00	0.500	170.22
4.60	0.810	129.77	3.122	-1.84	0.0259	-20.17	0.502	167.64
4.80	0.806	125.74	3.034	-6.43	0.0267	-20.38	0.504	164.95
5.00	0.802	121.53	2.956	-11.09	0.0276	-20.67	0.504	162.15
5.20	0.798	117.14	2.887	-15.84	0.0287	-21.10	0.504	159.21
5.40	0.794	112.55	2.825	-20.68	0.0300	-21.69	0.503	156.13
5.60	0.789	107.75	2.770	-25.62	0.0315	-22.49	0.502	152.90
5.80	0.785	102.74	2.719	-30.66	0.0331	-23.54	0.499	149.49
6.00	0.780	97.50	2.672	-35.82	0.0350	-24.86	0.496	145.89

**Typical Package S-Parameters for CG2H40010**  
**(Small Signal,  $V_{DS} = 28\text{ V}$ ,  $I_{DQ} = 500\text{ mA}$ , angle in degrees)**

Frequency	Mag S11	Ang S11	Mag S21	Ang S21	Mag S12	Ang S12	Mag S22	Ang S22
0.50	0.884	-133.72	22.181	103.56	0.0199	20.32	0.356	-129.90
0.60	0.878	-142.44	18.972	97.82	0.0203	15.95	0.358	-136.80
0.70	0.873	-149.25	16.532	93.01	0.0206	12.53	0.360	-141.87
0.80	0.870	-154.75	14.626	88.83	0.0208	9.75	0.363	-145.73
0.90	0.868	-159.35	13.103	85.08	0.0209	7.42	0.366	-148.77
1.00	0.866	-163.28	11.861	81.66	0.0210	5.42	0.369	-151.23
1.10	0.865	-166.73	10.830	78.47	0.0210	3.68	0.373	-153.26
1.20	0.864	-169.80	9.963	75.46	0.0210	2.13	0.376	-154.99
1.30	0.863	-172.59	9.223	72.59	0.0210	0.75	0.380	-156.50
1.40	0.862	-175.15	8.585	69.83	0.0210	-0.50	0.384	-157.83
1.50	0.861	-177.52	8.030	67.17	0.0210	-1.64	0.388	-159.04
1.60	0.861	-179.75	7.543	64.58	0.0209	-2.67	0.393	-160.15
1.70	0.860	178.13	7.112	62.05	0.0209	-3.61	0.397	-161.19
1.80	0.860	176.12	6.729	59.58	0.0208	-4.47	0.402	-162.19
1.90	0.859	174.18	6.386	57.15	0.0208	-5.25	0.406	-163.15
2.00	0.859	172.31	6.077	54.76	0.0207	-5.97	0.411	-164.08
2.10	0.858	170.49	5.797	52.40	0.0207	-6.61	0.415	-165.00
2.20	0.857	168.71	5.544	50.07	0.0207	-7.20	0.420	-165.92
2.30	0.857	166.97	5.313	47.76	0.0206	-7.72	0.424	-166.83
2.40	0.856	165.25	5.101	45.48	0.0206	-8.19	0.429	-167.74
2.50	0.856	163.56	4.907	43.21	0.0206	-8.60	0.433	-168.66
2.60	0.855	161.89	4.729	40.96	0.0205	-8.95	0.438	-169.59
2.70	0.854	160.23	4.564	38.72	0.0205	-9.26	0.442	-170.53
2.80	0.853	158.57	4.412	36.50	0.0205	-9.51	0.446	-171.48
2.90	0.853	156.92	4.271	34.28	0.0205	-9.71	0.451	-172.45
3.00	0.852	155.27	4.140	32.08	0.0206	-9.87	0.455	-173.43
3.20	0.850	151.96	3.904	27.68	0.0207	-10.05	0.462	-175.45
3.40	0.848	148.62	3.699	23.31	0.0209	-10.08	0.469	-177.54
3.60	0.846	145.23	3.520	18.93	0.0212	-10.00	0.476	-179.70
3.80	0.843	141.78	3.362	14.55	0.0215	-9.85	0.482	178.06
4.00	0.840	138.24	3.223	10.14	0.0220	-9.66	0.487	175.75
4.20	0.837	134.60	3.101	5.70	0.0227	-9.48	0.492	173.36
4.40	0.834	130.83	2.994	1.21	0.0235	-9.38	0.495	170.88
4.60	0.831	126.92	2.899	-3.33	0.0244	-9.39	0.498	168.30
4.80	0.827	122.84	2.816	-7.93	0.0256	-9.56	0.500	165.62
5.00	0.823	118.59	2.743	-12.62	0.0269	-9.95	0.502	162.83
5.20	0.819	114.14	2.678	-17.39	0.0284	-10.59	0.502	159.90
5.40	0.815	109.50	2.619	-22.25	0.0301	-11.49	0.502	156.82
5.60	0.811	104.65	2.566	-27.21	0.0320	-12.69	0.501	153.59
5.80	0.807	99.58	2.518	-32.28	0.0341	-14.20	0.499	150.18
6.00	0.802	94.29	2.473	-37.47	0.0364	-16.03	0.496	146.59

**Product Dimensions CG2H40010F (Package Type — 440166)**



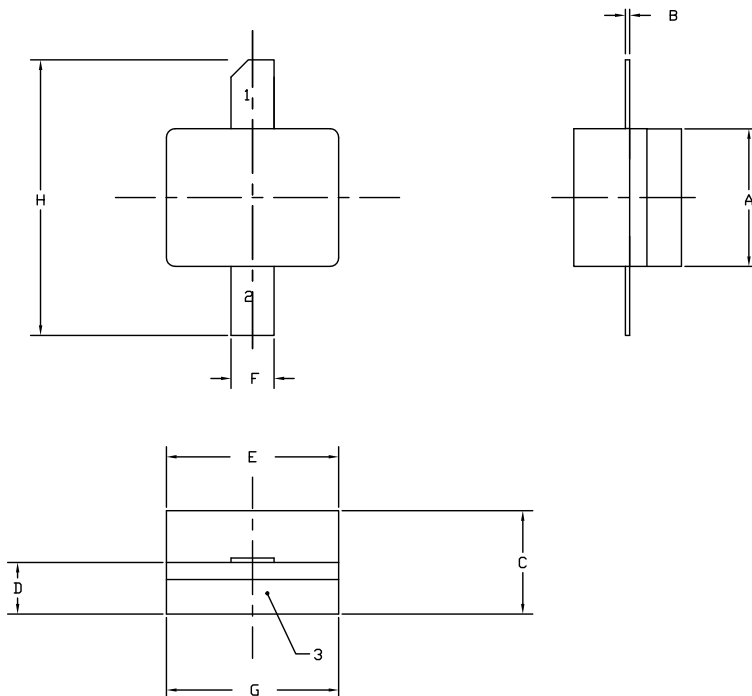
NOTES:

1. DIMENSIONING AND TOLERANCING PER ANSI Y14.5M, 1982.
2. CONTROLLING DIMENSION: INCH.
3. ADHESIVE FROM LID MAY EXTEND A MAXIMUM OF 0.020" BEYOND EDGE OF LID.
4. LID MAY BE MISALIGNED TO THE BODY OF THE PACKAGE BY A MAXIMUM OF 0.008" IN ANY DIRECTION.
5. ALL PLATED SURFACES ARE NI/AU

DIM	INCHES		MILLIMETERS	
	MIN	MAX	MIN	MAX
A	0.155	0.165	3.94	4.19
B	0.004	0.006	0.10	0.15
C	0.115	0.135	2.92	3.43
D	0.057	0.067	1.45	1.70
E	0.195	0.205	4.95	5.21
F	0.045	0.055	1.14	1.40
G	0.545	0.555	13.84	14.09
H	0.280	0.360	7.11	9.14
J	Ø .100		2.54	
K	0.375		9.53	

PIN 1. GATE  
 PIN 2. DRAIN  
 PIN 3. SOURCE

**Product Dimensions CG2H40010P (Package Type — 440196)**





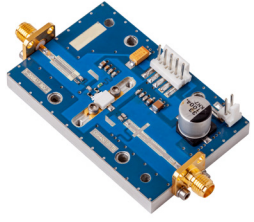
NOTES:

1. DIMENSIONING AND TOLERANCING PER ANSI Y14.5M, 1982.
2. CONTROLLING DIMENSION: INCH.
3. ADHESIVE FROM LID MAY EXTEND A MAXIMUM OF 0.020" BEYOND EDGE OF LID.
4. LID MAY BE MISALIGNED TO THE BODY OF THE PACKAGE BY A MAXIMUM OF 0.008" IN ANY DIRECTION.
5. ALL PLATED SURFACES ARE NI/AU

DIM	INCHES		MILLIMETERS	
	MIN	MAX	MIN	MAX
A	0.155	0.165	3.94	4.19
B	0.003	0.006	0.10	0.15
C	0.115	0.135	2.92	3.17
D	0.057	0.067	1.45	1.70
E	0.195	0.205	4.95	5.21
F	0.045	0.055	1.14	1.40
G	0.195	0.205	4.95	5.21
H	0.280	0.360	7.11	9.14

PIN 1. GATE  
 PIN 2. DRAIN  
 PIN 3. SOURCE

**Product Ordering Information**

Order Number	Description	Unit of Measure	Image
CG2H40010F	GaN HEMT	Each	
CG2H40010P	GaN HEMT	Each	
CG2H40010F-AMP	Test board with GaN HEMT installed	Each	

## Notes & Disclaimer

---

MACOM Technology Solutions Inc. ("MACOM"). All rights reserved.

These materials are provided in connection with MACOM's products as a service to its customers and may be used for informational purposes only. Except as provided in its Terms and Conditions of Sale or any separate agreement, MACOM assumes no liability or responsibility whatsoever, including for (i) errors or omissions in these materials; (ii) failure to update these materials; or (iii) conflicts or incompatibilities arising from future changes to specifications and product descriptions, which MACOM may make at any time, without notice. These materials grant no license, express or implied, to any intellectual property rights.

THESE MATERIALS ARE PROVIDED "AS IS" WITH NO WARRANTY OR LIABILITY, EXPRESS OR IMPLIED, RELATING TO SALE AND/OR USE OF MACOM PRODUCTS INCLUDING FITNESS FOR A PARTICULAR PURPOSE, MERCHANTABILITY, INFRINGEMENT OF INTELLECTUAL PROPERTY RIGHT, ACCURACY OR COMPLETENESS, OR SPECIAL, INDIRECT, INCIDENTAL, OR CONSEQUENTIAL DAMAGES WHICH MAY RESULT FROM USE OF THESE MATERIALS.

MACOM products are not intended for use in medical, lifesaving or life sustaining applications. MACOM customers using or selling MACOM products for use in such applications do so at their own risk and agree to fully indemnify MACOM for any damages resulting from such improper use or sale.