

DS25CP102 3.125 Gbps 2X2 LVDS Crosspoint Switch with Transmit Pre-Emphasis and Receive Equalization

Check for Samples: [DS25CP102](#)

FEATURES

- DC - 3.125 Gbps Low Jitter, Low Skew, Low Power Operation
- Pin Configurable, Fully Differential, Non-Blocking Architecture
- Pin Selectable Transmit Pre-Emphasis and Receive Equalization Eliminate Data Dependant Jitter
- Wide Input Common Mode Voltage Range Allows DC-Coupled Interface to CML and LVPECL Drivers
- On-Chip 100Ω Input and Output Termination Minimizes Insertion and Return Losses, Reduces Component Count, Minimizes Board Space
- 8 kV ESD on LVDS I/O Pins Protects Adjoining Components
- Small 4 mm x 4 mm WQFN-16 Space Saving Package

APPLICATIONS

- High-Speed Channel Select Applications
- Clock and Data Buffering and Muxing
- OC-48 / STM-16
- SD/HD/3GHD SDI Routers

DESCRIPTION

The DS25CP102 is a 3.125 Gbps 2x2 LVDS crosspoint switch optimized for high-speed signal routing and switching over lossy FR-4 printed circuit board backplanes and balanced cables. Fully differential signal paths ensure exceptional signal integrity and noise immunity. The non-blocking architecture allows connections of any input to any output or outputs.

The DS25CP102 features two levels (Off and On) of transmit pre-emphasis (PE) and two levels (Off and On) of receive equalization (EQ).

Wide input common mode range allows the switch to accept signals with LVDS, CML and LVPECL levels; the output levels are LVDS. A very small package footprint requires a minimal space on the board while the flow-through pinout allows easy board layout. Each differential input and output is internally terminated with a 100Ω resistor to lower device insertion and return losses, reduce component count and further minimize board space.



Please be aware that an important notice concerning availability, standard warranty, and use in critical applications of Texas Instruments semiconductor products and disclaimers thereto appears at the end of this data sheet.

All trademarks are the property of their respective owners.

Typical Application

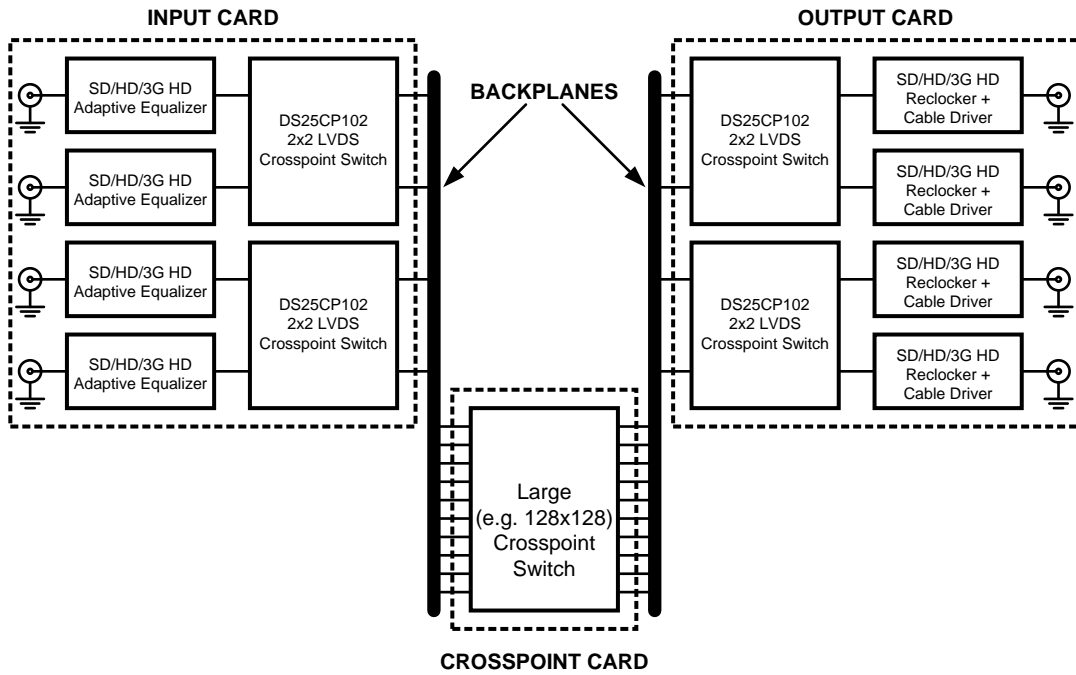

Block Diagram

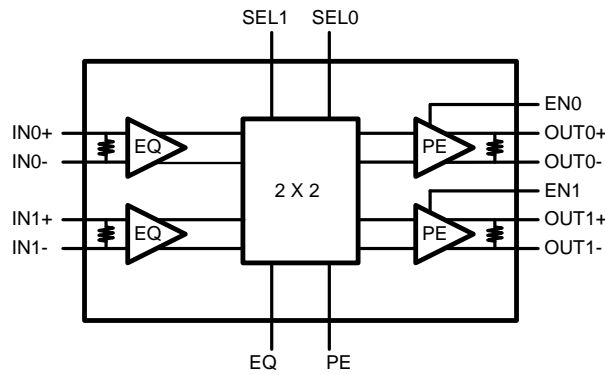

Connection Diagram

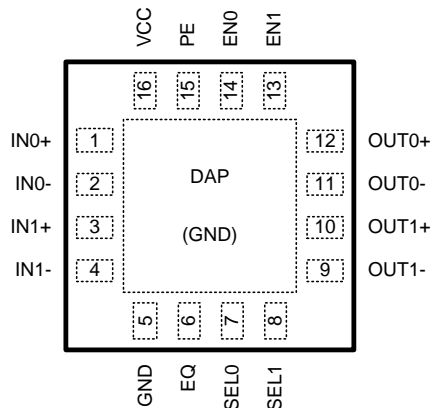

PIN DESCRIPTIONS

Pin Name	Pin Number	I/O, Type	Pin Description
IN0+, IN0-, IN1+, IN1-	1, 2, 3, 4	I, LVDS	Inverting and non-inverting high speed LVDS input pins.
OUT0+, OUT0-, OUT1+, OUT1-	12, 11, 10, 9	O, LVDS	Inverting and non-inverting high speed LVDS output pins.
SEL0, SEL1	7, 8	I, LVCMOS	Switch configuration pins. There is a 20k pulldown resistor on this pin.
EN0, EN1	14, 13	I, LVCMOS	Output enable pins. There is a 20k pulldown resistor on this pin.
PE	15	I, LVCMOS	Transmit Pre-Emphasis select pin. There is a 20k pulldown resistor on this pin.
EQ	6	I, LVCMOS	Receive Equalization select pin. There is a 20k pulldown resistor on this pin.
VDD	16	Power	Power supply pin.
GND	5, DAP	Power	Ground pin and Device Attach Pad (DAP) ground.



These devices have limited built-in ESD protection. The leads should be shorted together or the device placed in conductive foam during storage or handling to prevent electrostatic damage to the MOS gates.

Absolute Maximum Ratings⁽¹⁾⁽²⁾

Supply Voltage	-0.3V to +4V
LVCMOS Input Voltage	-0.3V to (V _{CC} + 0.3V)
LVDS Input Voltage	-0.3V to +4V
Differential Input Voltage VID	1.0V
LVDS Output Voltage	-0.3V to (V _{CC} + 0.3V)
LVDS Differential Output Voltage	0V to 1.0V
LVDS Output Short Circuit Current Duration	5 ms
Junction Temperature	+150°C
Storage Temperature Range	-65°C to +150°C
Lead Temperature Range	
Soldering (4 sec.)	+260°C
Maximum Package Power Dissipation at 25°C	
RGH0016A Package	2.99W
Derate RGH0016A Package	23.9 mW/°C above +25°C
Package Thermal Resistance	
θ_{JA}	+41.8°C/W
θ_{JC}	+6.9°C/W
ESD Susceptibility	
HBM ⁽³⁾	≥8 kV
MM ⁽⁴⁾	≥250V
CDM ⁽⁵⁾	≥1250V

- (1) "Absolute Maximum Ratings" indicate limits beyond which damage to the device may occur, including inoperability and degradation of device reliability and/or performance. Functional operation of the device and/or non-degradation at the [Absolute Maximum Ratings](#) or other conditions beyond those indicated in the [Recommended Operating Conditions](#) is not implied. The Recommended Operating Conditions indicate conditions at which the device is functional and the device should not be operated beyond such conditions.
- (2) If Military/Aerospace specified devices are required, please contact the TI Sales Office/Distributors for availability and specifications.
- (3) Human Body Model, applicable std. JESD22-A114C
- (4) Machine Model, applicable std. JESD22-A115-A
- (5) Field Induced Charge Device Model, applicable std. JESD22-C101-C

Recommended Operating Conditions

	Min	Typ	Max	Units
Supply Voltage (V_{CC})	3.0	3.3	3.6	V
Receiver Differential Input Voltage (V_{ID})	0		1	V
Operating Free Air Temperature (T_A)	-40	+25	+85	°C

DC Electrical Characteristics ⁽¹⁾⁽²⁾⁽³⁾

Over recommended operating supply and temperature ranges unless otherwise specified.

Symbol	Parameter	Conditions	Min	Typ	Max	Units
LVCMOS DC SPECIFICATIONS						
V_{IH}	High Level Input Voltage		2.0		V_{CC}	V
V_{IL}	Low Level Input Voltage		GND		0.8	V
I_{IH}	High Level Input Current	$V_{IN} = 3.6V$ $V_{CC} = 3.6V$	40	175	250	μA
I_{IL}	Low Level Input Current	$V_{IN} = GND$ $V_{CC} = 3.6V$		0	± 10	μA
V_{CL}	Input Clamp Voltage	$I_{CL} = -18 mA$, $V_{CC} = 0V$		-0.9	-1.5	V
LVDS INPUT DC SPECIFICATIONS						
V_{ID}	Input Differential Voltage		0		1	V
V_{TH}	Differential Input High Threshold	$V_{CM} = +0.05V$ or $V_{CC}-0.05V$		0	+100	mV
V_{TL}	Differential Input Low Threshold		-100	0		mV
V_{CMR}	Common Mode Voltage Range	$V_{ID} = 100 mV$	0.05		$V_{CC} - 0.05$	V
I_{IN}	Input Current	$V_{IN} = +3.6V$ or $0V$ $V_{CC} = 3.6V$ or $0V$		± 1	± 10	μA
C_{IN}	Input Capacitance	Any LVDS Input Pin to GND		1.7		pF
R_{IN}	Input Termination Resistor	Between IN+ and IN-		100		Ω
LVDS OUTPUT DC SPECIFICATIONS						
V_{OD}	Differential Output Voltage	$R_L = 100\Omega$	250	350	450	mV
ΔV_{OD}	Change in Magnitude of V_{OD} for Complimentary Output States		-35		35	mV
V_{OS}	Offset Voltage	$R_L = 100\Omega$	1.05	1.2	1.375	V
ΔV_{OS}	Change in Magnitude of V_{OS} for Complimentary Output States		-35		35	mV
I_{OS}	Output Short Circuit Current ⁽⁴⁾	OUT to GND		-35	-55	mA
		OUT to V_{CC}		7	55	mA
C_{OUT}	Output Capacitance	Any LVDS Output Pin to GND		1.2		pF
R_{OUT}	Output Termination Resistor	Between OUT+ and OUT-		100		Ω
SUPPLY CURRENT						
I_{CC}	Supply Current	PE = OFF, EQ = OFF		77	90	mA
I_{CCZ}	Supply Current with Outputs Disabled	EN0 = EN1 = 0		23	29	mA

- (1) The Electrical Characteristics tables list guaranteed specifications under the listed [Recommended Operating Conditions](#) except as otherwise modified or specified by the Electrical Characteristics Conditions and/or Notes. Typical specifications are estimations only and are not guaranteed.
- (2) Current into device pins is defined as positive. Current out of device pins is defined as negative. All voltages are referenced to ground except V_{OD} and ΔV_{OD} .
- (3) Typical values represent most likely parametric norms for $V_{CC} = +3.3V$ and $T_A = +25^\circ C$, and at the Recommended Operation Conditions at the time of product characterization and are not guaranteed.
- (4) Output short circuit current (I_{OS}) is specified as magnitude only, minus sign indicates direction only.

AC Electrical Characteristics ⁽¹⁾

Over recommended operating supply and temperature ranges unless otherwise specified. ⁽²⁾ ⁽³⁾

Symbol	Parameter	Conditions	Min	Typ	Max	Units
LVDS OUTPUT AC SPECIFICATIONS						
t_{PLHD}	Differential Propagation Delay Low to High	$R_L = 100\Omega$		365	500	ps
t_{PHLD}	Differential Propagation Delay High to Low			345	500	ps
t_{SKD1}	Pulse Skew $ t_{PLHD} - t_{PHLD} $ ⁽⁴⁾			20	55	ps
t_{SKD2}	Channel to Channel Skew ⁽⁵⁾			12	25	ps
t_{SKD3}	Part to Part Skew ⁽⁶⁾			50	150	ps
t_{LHT}	Rise Time	$R_L = 100\Omega$		65	120	ps
t_{HLT}	Fall Time			65	120	ps
t_{ON}	Output Enable Time	ENn = LH to output active		7	20	μ s
t_{OFF}	Output Disable Time	ENn = HL to output inactive		5	12	ns
t_{SEL}	Select Time	SELn LH or HL to output		3.5	12	ns
JITTER PERFORMANCE WITH EQ = Off, PE = Off (Figure 5)						
t_{RJ1}	Random Jitter (RMS Value) No Test Channels ⁽⁷⁾	$V_{ID} = 350\text{ mV}$ $V_{CM} = 1.2\text{ V}$ Clock (RZ)	2.5 Gbps	0.5	1	ps
t_{RJ2}			3.125 Gbps	0.5	1	ps
t_{DJ1}	Deterministic Jitter (Peak to Peak) No Test Channels ⁽⁸⁾	$V_{ID} = 350\text{ mV}$ $V_{CM} = 1.2\text{ V}$ K28.5 (NRZ)	2.5 Gbps	6	22	ps
t_{DJ2}			3.125 Gbps	6	22	ps
t_{TJ1}	Total Jitter (Peak to Peak) No Test Channels ⁽⁹⁾	$V_{ID} = 350\text{ mV}$ $V_{CM} = 1.2\text{ V}$ PRBS-23 (NRZ)	2.5 Gbps	0.03	0.08	UI _{P-P}
t_{TJ2}			3.125 Gbps	0.05	0.11	UI _{P-P}
JITTER PERFORMANCE WITH EQ = Off, PE = On (Figure 6, Figure 9)						
t_{RJ1B}	Random Jitter (RMS Value) Test Channel B ⁽⁷⁾	$V_{ID} = 350\text{ mV}$ $V_{CM} = 1.2\text{ V}$ Clock (RZ)	2.5 Gbps	0.5	1	ps
t_{RJ2B}			3.125 Gbps	0.5	1	ps
t_{DJ1B}	Deterministic Jitter (Peak to Peak) Test Channel B ⁽⁸⁾	$V_{ID} = 350\text{ mV}$ $V_{CM} = 1.2\text{ V}$ K28.5 (NRZ)	2.5 Gbps	3	12	ps
t_{DJ2B}			3.125 Gbps	3	12	ps
t_{TJ1B}	Total Jitter (Peak to Peak) Test Channel B ⁽⁹⁾	$V_{ID} = 350\text{ mV}$ $V_{CM} = 1.2\text{ V}$ PRBS-23 (NRZ)	2.5 Gbps	0.03	0.06	UI _{P-P}
t_{TJ2B}			3.125 Gbps	0.04	0.09	UI _{P-P}
JITTER PERFORMANCE WITH EQ = On, PE = Off (Figure 7, Figure 9)						
t_{RJ1D}	Random Jitter (RMS Value) Test Channel D ⁽⁷⁾	$V_{ID} = 350\text{ mV}$ $V_{CM} = 1.2\text{ V}$ Clock (RZ)	2.5 Gbps	0.5	1	ps
t_{RJ2D}			3.125 Gbps	0.5	1	ps
t_{DJ1D}	Deterministic Jitter (Peak to Peak) Test Channel D ⁽⁸⁾	$V_{ID} = 350\text{ mV}$ $V_{CM} = 1.2\text{ V}$ K28.5 (NRZ)	2.5 Gbps	16	24	ps
t_{DJ2D}			3.125 Gbps	12	24	ps

- (1) Specification is guaranteed by characterization and is not tested in production.
- (2) The Electrical Characteristics tables list guaranteed specifications under the listed [Recommended Operating Conditions](#) except as otherwise modified or specified by the Electrical Characteristics Conditions and/or Notes. Typical specifications are estimations only and are not guaranteed.
- (3) Typical values represent most likely parametric norms for $V_{CC} = +3.3\text{ V}$ and $T_A = +25^\circ\text{ C}$, and at the Recommended Operation Conditions at the time of product characterization and are not guaranteed.
- (4) t_{SKD1} , $|t_{PLHD} - t_{PHLD}|$, Pulse Skew, is the magnitude difference in differential propagation delay time between the positive going edge and the negative going edge of the same channel.
- (5) t_{SKD2} , Channel to Channel Skew, is the difference in propagation delay (t_{PLHD} or t_{PHLD}) among all output channels in Broadcast mode (any one input to all outputs).
- (6) t_{SKD3} , Part to Part Skew, is defined as the difference between the minimum and maximum differential propagation delays. This specification applies to devices at the same V_{CC} and within 5° C of each other within the operating temperature range.
- (7) Measured on a clock edge with a histogram and an accumulation of 1500 histogram hits. Input stimulus jitter is subtracted geometrically.
- (8) Tested with a combination of the 110000101 (K28.5+ character) and 0011111010 (K28.5- character) patterns. Input stimulus jitter is subtracted algebraically.
- (9) Measured on an eye diagram with a histogram and an accumulation of 3500 histogram hits. Input stimulus jitter is subtracted.

AC Electrical Characteristics ⁽¹⁾ (continued)

Over recommended operating supply and temperature ranges unless otherwise specified. ⁽²⁾ ⁽³⁾

Symbol	Parameter	Conditions	Min	Typ	Max	Units
t_{TJ1D}	Total Jitter (Peak to Peak) Test Channel D	$V_{ID} = 350\text{ mV}$ $V_{CM} = 1.2\text{V}$ PRBS-23 (NRZ)	2.5 Gbps	0.07	0.11	UI _{P-P}
t_{TJ2D}	(9)		3.125 Gbps	0.07	0.11	UI _{P-P}
JITTER PERFORMANCE WITH EQ = On, PE = On (Figure 8, Figure 9)						
t_{RJ1BD}	Random Jitter (RMS Value) Input Test Channel D	$V_{ID} = 350\text{ mV}$ $V_{CM} = 1.2\text{V}$ Clock (RZ)	2.5 Gbps	0.5	1	ps
t_{RJ2BD}	Output Test Channel B (7)		3.125 Gbps	0.5	1	ps
t_{DJ1BD}	Deterministic Jitter (Peak to Peak) Input Test Channel D	$V_{ID} = 350\text{ mV}$ $V_{CM} = 1.2\text{V}$ K28.5 (NRZ)	2.5 Gbps	14	31	ps
t_{DJ2BD}	Output Test Channel B (8)		3.125 Gbps	6	21	ps
t_{TJ1BD}	Total Jitter (Peak to Peak) Input Test Channel D	$V_{ID} = 350\text{ mV}$ $V_{CM} = 1.2\text{V}$ PRBS-23 (NRZ)	2.5 Gbps	0.08	0.15	UI _{P-P}
t_{TJ2BD}	Output Test Channel B (9)		3.125 Gbps	0.10	0.16	UI _{P-P}

DC TEST CIRCUITS

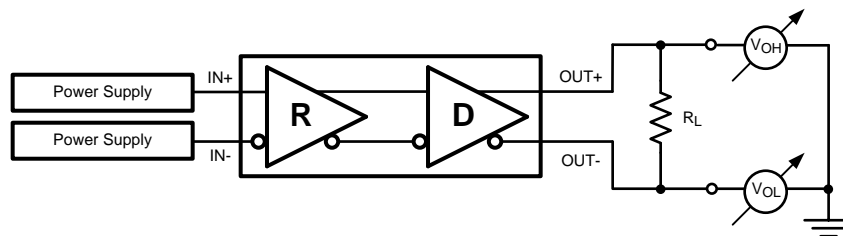

Figure 1. Differential Driver DC Test Circuit

AC Test Circuits and Timing Diagrams

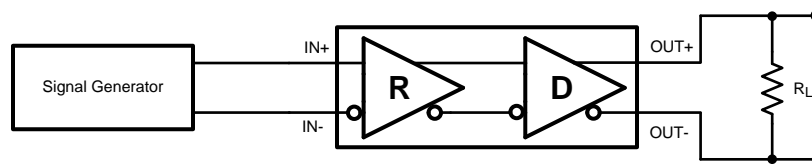

Figure 2. Differential Driver AC Test Circuit

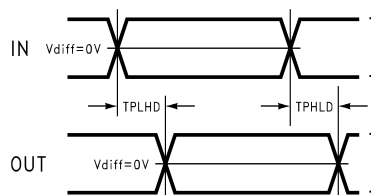

Figure 3. Propagation Delay Timing Diagram

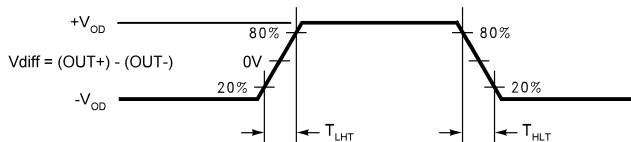

Figure 4. LVDS Output Transition Times

Pre-Emphasis and Equalization Test Circuits

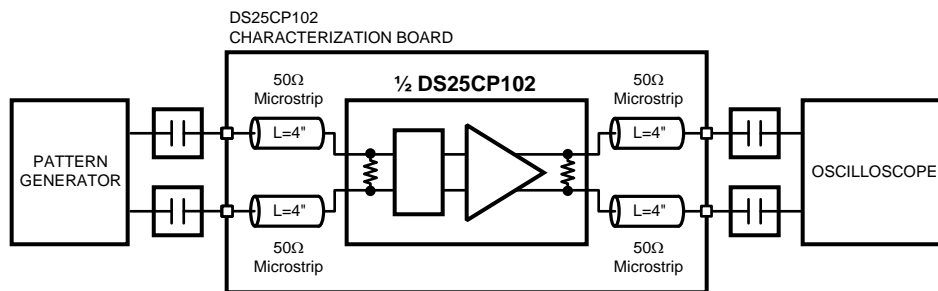

Figure 5. Jitter Performance Test Circuit

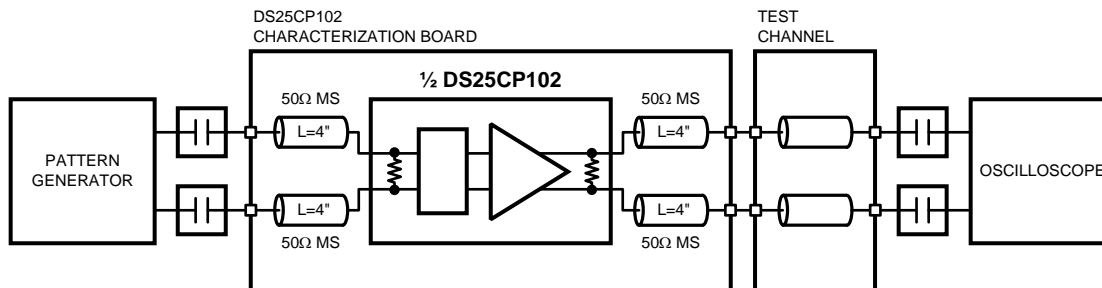

Figure 6. Pre-Emphasis Performance Test Circuit

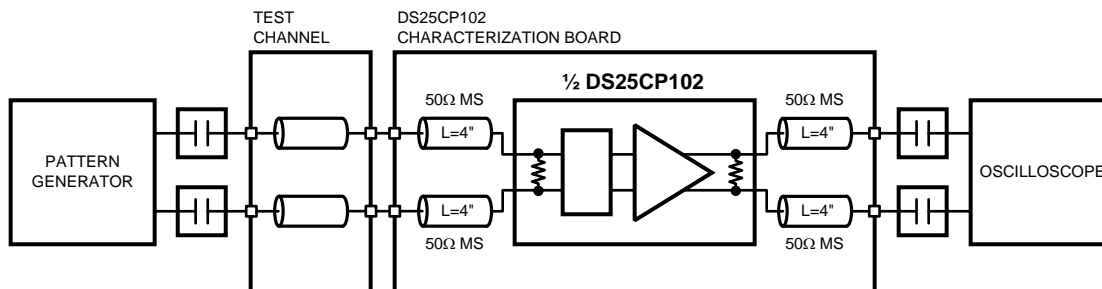

Figure 7. Equalization Performance Test Circuit

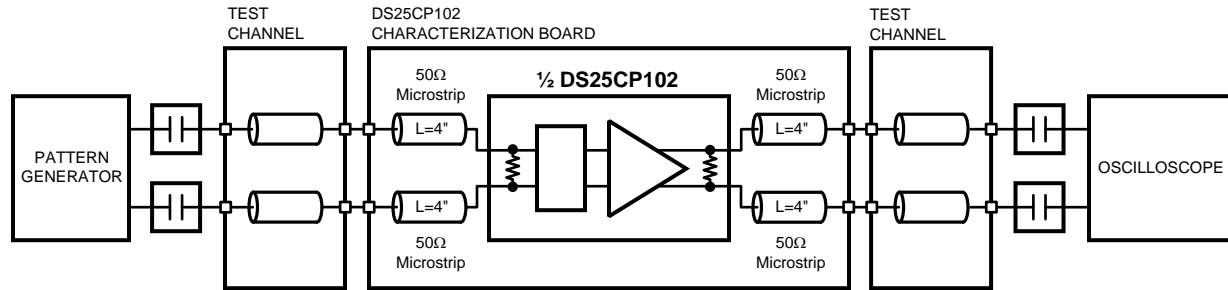

Figure 8. Pre-Emphasis and Equalization Performance Test Circuit

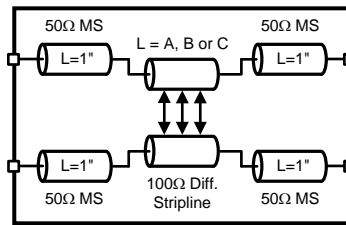

Figure 9. Test Channel Block Diagram

Test Channel Loss Characteristics

The test channel was fabricated with Polyclad PCL-FR-370-Laminate/PCL-FRP-370 Prepreg materials (Dielectric constant of 3.7 and Loss Tangent of 0.02). The edge coupled differential striplines have the following geometries: Trace Width (W) = 5 mils, Gap (S) = 5 mils, Height (B) = 16 mils.

Test Channel	Length (inches)	Insertion Loss (dB)					
		500 MHz	750 MHz	1000 MHz	1250 MHz	1500 MHz	1560 MHz
A	10	-1.2	-1.7	-2.0	-2.4	-2.7	-2.8
B	20	-2.6	-3.5	-4.1	-4.8	-5.5	-5.6
C	30	-4.3	-5.7	-7.0	-8.2	-9.4	-9.7
D	15	-1.6	-2.2	-2.7	-3.2	-3.7	-3.8
E	30	-3.4	-4.5	-5.6	-6.6	-7.7	-7.9
F	60	-7.8	-10.3	-12.4	-14.5	-16.6	-17.0

Functional Description

The DS25CP102 is a 3.125 Gbps 2x2 LVDS digital crosspoint switch optimized for high-speed signal routing and switching over lossy FR-4 printed circuit board backplanes and balanced cables.

Table 1. Switch Configuration Truth Table

SEL1	SEL0	OUT1	OUT0
0	0	IN0	IN0
0	1	IN0	IN1
1	0	IN1	IN0
1	1	IN1	IN1

Table 2. Output Enable Truth Table

EN1	EN0	OUT1	OUT0
0	0	Disabled	Disabled
0	1	Disabled	Enabled
1	0	Enabled	Disabled
1	1	Enabled	Enabled

In addition, the DS25CP102 has a pre-emphasis control pin for switching the transmit pre-emphasis to ON and OFF setting and an equalization control pin for switching the receive equalization to ON and OFF setting. The following are the transmit pre-emphasis and receive equalization truth tables.

Table 3. Transmit Pre-Emphasis Truth Table⁽¹⁾

OUTPUTS OUT0 and OUT1	
CONTROL Pin (PE) State	Pre-Emphasis Level
0	OFF
1	ON

(1) Transmit Pre-Emphasis Level Selection

Table 4. Receive Equalization Truth Table⁽¹⁾

INPUTS IN0 and IN1	
CONTROL Pin (EQ) State	Equalization Level
0	OFF
1	ON

(1) Receive Equalization Level Selection

Input Interfacing

The DS25CP102 accepts differential signals and allows simple AC or DC coupling. With a wide common mode range, the DS25CP102 can be DC-coupled with all common differential drivers (i.e. LVPECL, LVDS, CML). The following three figures illustrate typical DC-coupled interface to common differential drivers. Note that the DS25CP102 inputs are internally terminated with a 100Ω resistor.

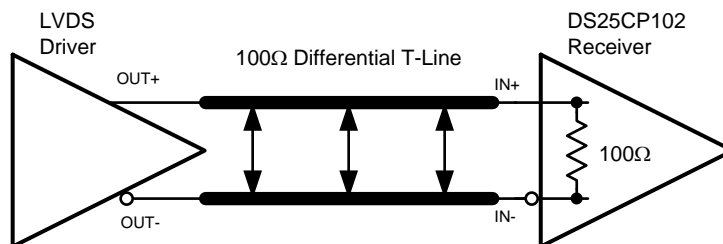

Figure 10. Typical LVDS Driver DC-Coupled Interface to DS25CP102 Input

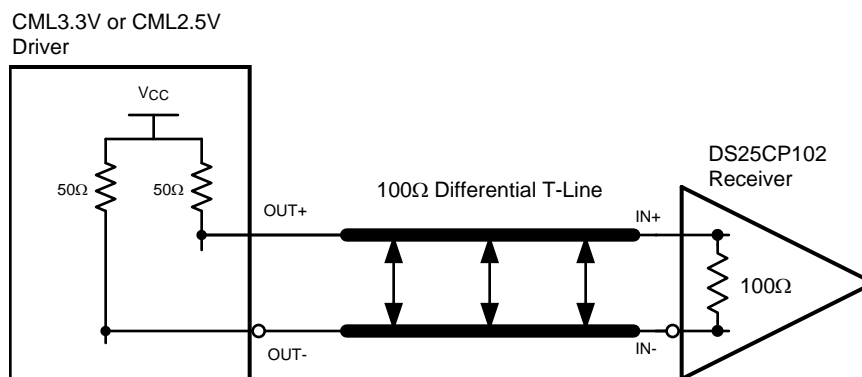

Figure 11. Typical CML Driver DC-Coupled Interface to DS25CP102 Input

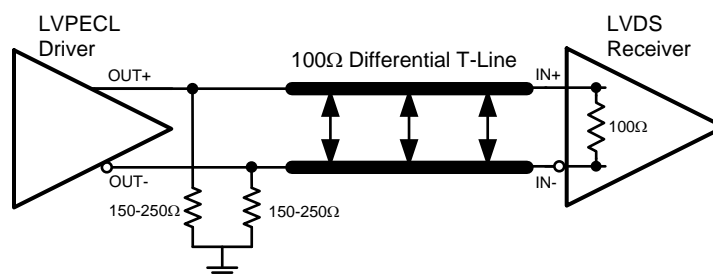

Figure 12. Typical LVPECL Driver DC-Coupled Interface to DS25CP102 Input

Output Interfacing

The DS25CP102 outputs signals that are compliant to the LVDS standard. Its outputs can be DC-coupled to most common differential receivers. The following figure illustrates typical DC-coupled interface to common differential receivers and assumes that the receivers have high impedance inputs. While most differential receivers have a common mode input range that can accommodate LVDS compliant signals, it is recommended to check respective receiver's data sheet prior to implementing the suggested interface implementation.

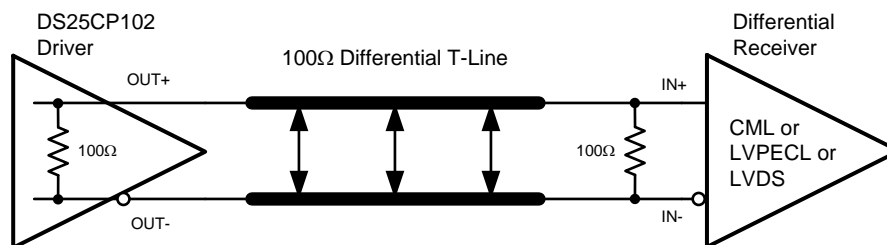

Figure 13. Typical DS25CP102 Output DC-Coupled Interface to an LVDS, CML or LVPECL Receiver

Typical Performance Characteristics

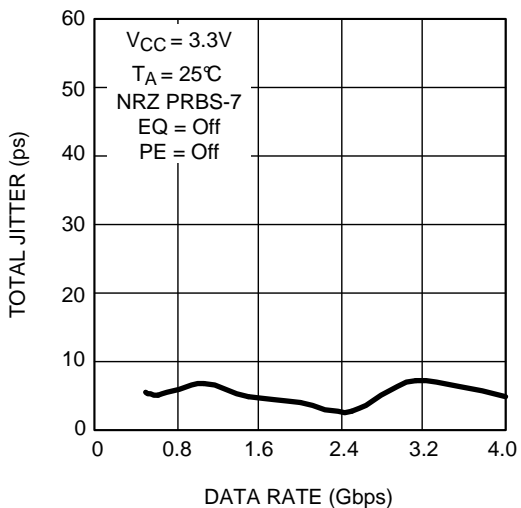

Figure 14. Total Jitter as a Function of Data Rate

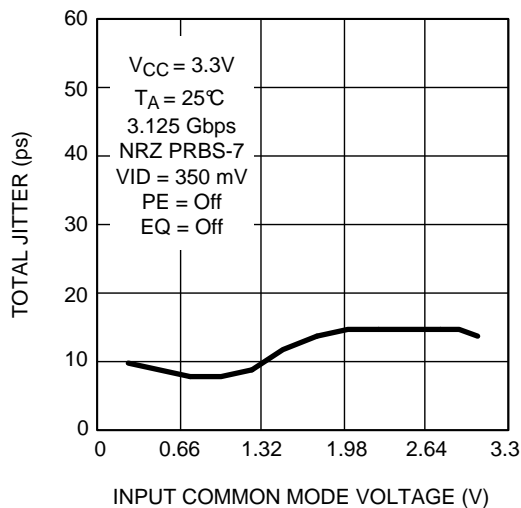

Figure 15. Total Jitter as a Function of Input Common Mode Voltage

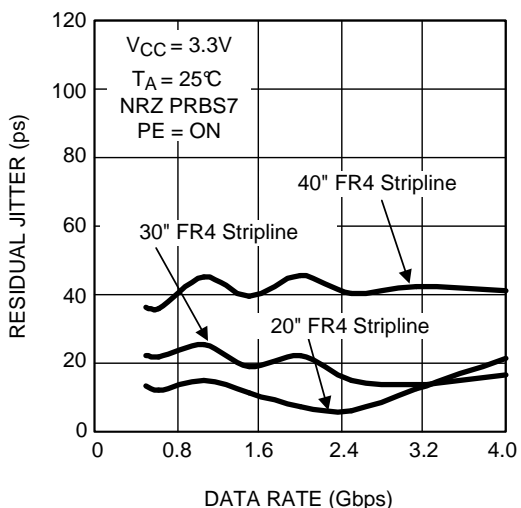

Figure 16. Residual Jitter as a Function of Data Rate, FR4 Stripline Length and PE Level

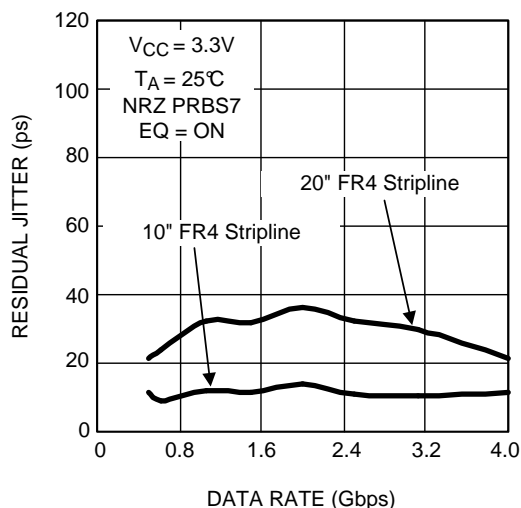

Figure 17. Residual Jitter as a Function of Data Rate, FR4 Stripline Length and EQ Level

Typical Performance Characteristics (continued)

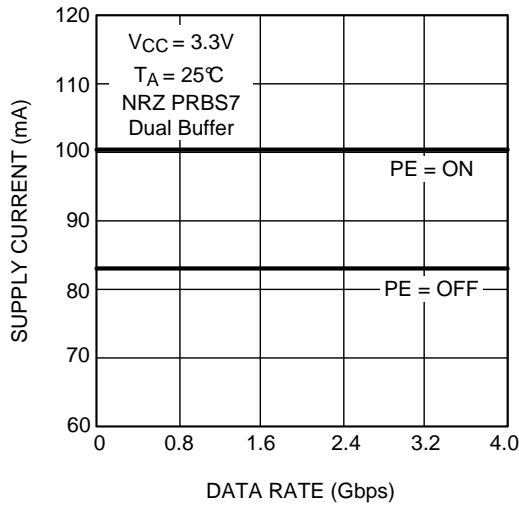

Figure 18. Supply Current as a Function of Data Rate and PE Level

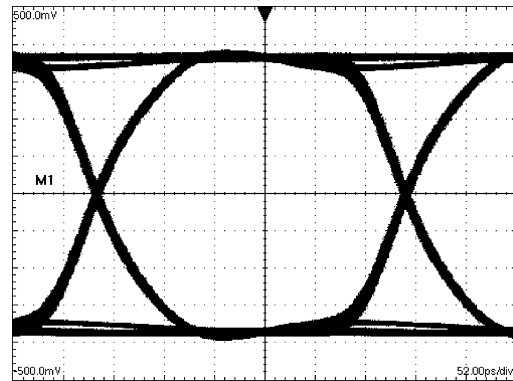

Figure 19. A 3.125 Gbps NRZ PRBS-7 without PE or EQ After 2" Differential FR-4 Stripline
H: 50 ps / DIV, V: 100 mV / DIV

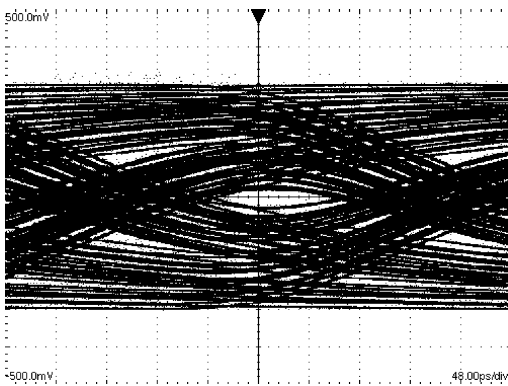

Figure 20. A 3.125 Gbps NRZ PRBS-7 without PE or EQ After 40" Differential FR-4 Stripline
H: 50 ps / DIV, V: 100 mV / DIV

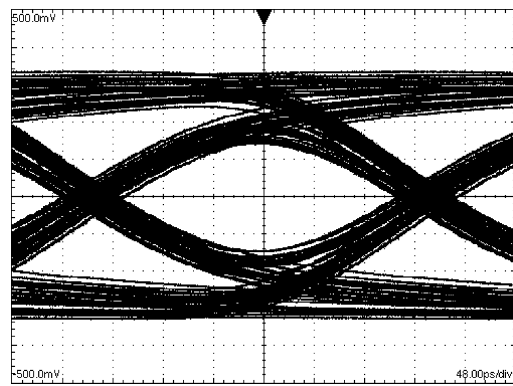

Figure 21. A 3.125 Gbps NRZ PRBS-7 with PE After 40" Differential FR-4 Stripline
H: 50 ps / DIV, V: 100 mV / DIV

REVISION HISTORY

Changes from Revision D (March 2013) to Revision E	Page
<hr/> <ul style="list-style-type: none">• Changed layout of National Data Sheet to TI format	<hr/> 12

PACKAGING INFORMATION

Orderable Device	Status (1)	Package Type	Package Drawing	Pins	Package Qty	Eco Plan (2)	Lead/Ball Finish (6)	MSL Peak Temp (3)	Op Temp (°C)	Device Marking (4/5)	Samples
DS25CP102TSQ/NOPB	ACTIVE	WQFN	RGH	16	1000	Green (RoHS & no Sb/Br)	CU SN	Level-1-260C-UNLIM	-40 to 85	2C102SQ	Samples

(1) The marketing status values are defined as follows:

ACTIVE: Product device recommended for new designs.

LIFEBUY: TI has announced that the device will be discontinued, and a lifetime-buy period is in effect.

NRND: Not recommended for new designs. Device is in production to support existing customers, but TI does not recommend using this part in a new design.

PREVIEW: Device has been announced but is not in production. Samples may or may not be available.

OBSELETE: TI has discontinued the production of the device.

(2) Eco Plan - The planned eco-friendly classification: Pb-Free (RoHS), Pb-Free (RoHS Exempt), or Green (RoHS & no Sb/Br) - please check <http://www.ti.com/productcontent> for the latest availability information and additional product content details.

TBD: The Pb-Free/Green conversion plan has not been defined.

Pb-Free (RoHS): TI's terms "Lead-Free" or "Pb-Free" mean semiconductor products that are compatible with the current RoHS requirements for all 6 substances, including the requirement that lead not exceed 0.1% by weight in homogeneous materials. Where designed to be soldered at high temperatures, TI Pb-Free products are suitable for use in specified lead-free processes.

Pb-Free (RoHS Exempt): This component has a RoHS exemption for either 1) lead-based flip-chip solder bumps used between the die and package, or 2) lead-based die adhesive used between the die and leadframe. The component is otherwise considered Pb-Free (RoHS compatible) as defined above.

Green (RoHS & no Sb/Br): TI defines "Green" to mean Pb-Free (RoHS compatible), and free of Bromine (Br) and Antimony (Sb) based flame retardants (Br or Sb do not exceed 0.1% by weight in homogeneous material)

(3) MSL, Peak Temp. - The Moisture Sensitivity Level rating according to the JEDEC industry standard classifications, and peak solder temperature.

(4) There may be additional marking, which relates to the logo, the lot trace code information, or the environmental category on the device.

(5) Multiple Device Markings will be inside parentheses. Only one Device Marking contained in parentheses and separated by a "~" will appear on a device. If a line is indented then it is a continuation of the previous line and the two combined represent the entire Device Marking for that device.

(6) Lead/Ball Finish - Orderable Devices may have multiple material finish options. Finish options are separated by a vertical ruled line. Lead/Ball Finish values may wrap to two lines if the finish value exceeds the maximum column width.

Important Information and Disclaimer: The information provided on this page represents TI's knowledge and belief as of the date that it is provided. TI bases its knowledge and belief on information provided by third parties, and makes no representation or warranty as to the accuracy of such information. Efforts are underway to better integrate information from third parties. TI has taken and continues to take reasonable steps to provide representative and accurate information but may not have conducted destructive testing or chemical analysis on incoming materials and chemicals. TI and TI suppliers consider certain information to be proprietary, and thus CAS numbers and other limited information may not be available for release.

In no event shall TI's liability arising out of such information exceed the total purchase price of the TI part(s) at issue in this document sold by TI to Customer on an annual basis.

TAPE AND REEL INFORMATION



QUADRANT ASSIGNMENTS FOR PIN 1 ORIENTATION IN TAPE



*All dimensions are nominal

Device	Package Type	Package Drawing	Pins	SPQ	Reel Diameter (mm)	Reel Width W1 (mm)	A0 (mm)	B0 (mm)	K0 (mm)	P1 (mm)	W (mm)	Pin1 Quadrant
DS25CP102TSQ/NOPB	WQFN	RGH	16	1000	178.0	12.4	4.3	4.3	1.3	8.0	12.0	Q1

TAPE AND REEL BOX DIMENSIONS



*All dimensions are nominal

Device	Package Type	Package Drawing	Pins	SPQ	Length (mm)	Width (mm)	Height (mm)
DS25CP102TSQ/NOPB	WQFN	RGH	16	1000	210.0	185.0	35.0

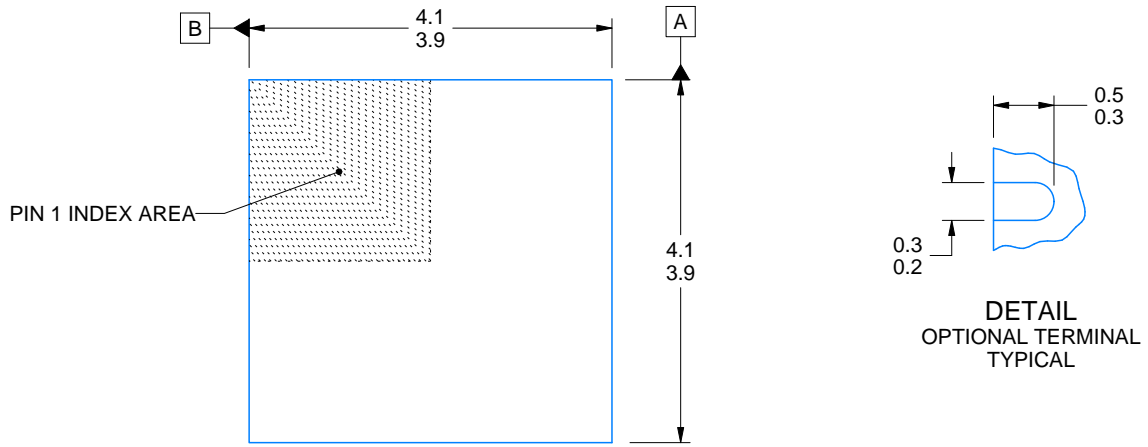
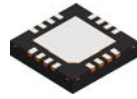

DIM A	
OPT 1	OPT 1
(0.1)	(0.2)

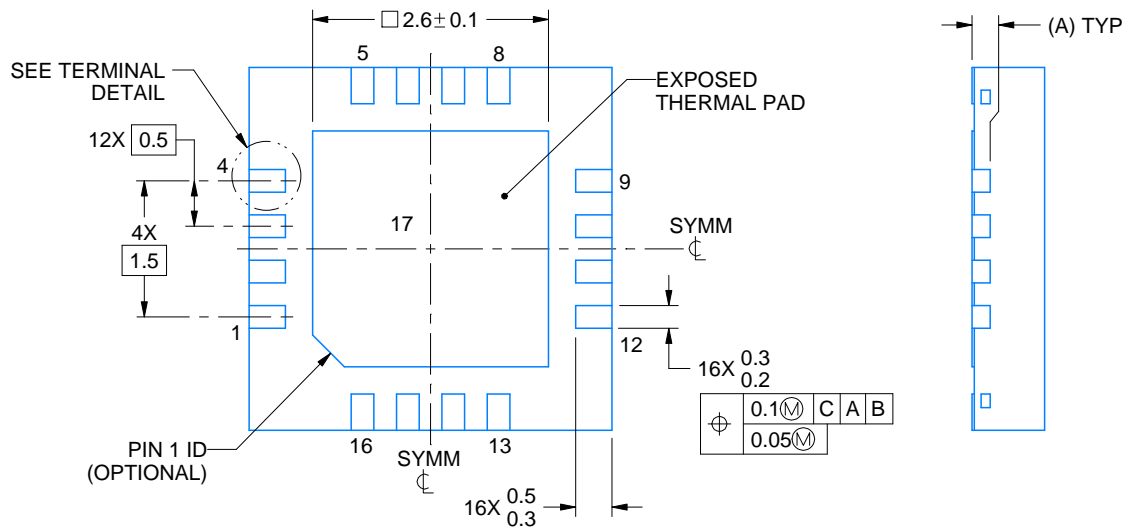
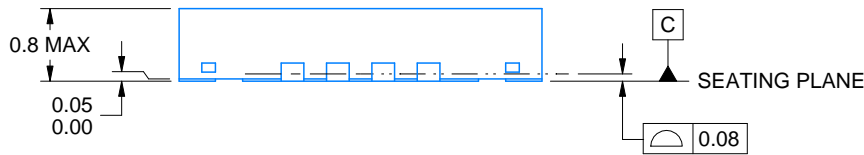

4214978/B 01/2017

NOTES:

1. All linear dimensions are in millimeters. Any dimensions in parenthesis are for reference only. Dimensioning and tolerancing per ASME Y14.5M.
2. This drawing is subject to change without notice.
3. The package thermal pad must be soldered to the printed circuit board for optimal thermal and mechanical performance.

EXAMPLE BOARD LAYOUT

RGH0016A

WQFN - 0.8 mm max height

PLASTIC QUAD FLATPACK - NO LEAD

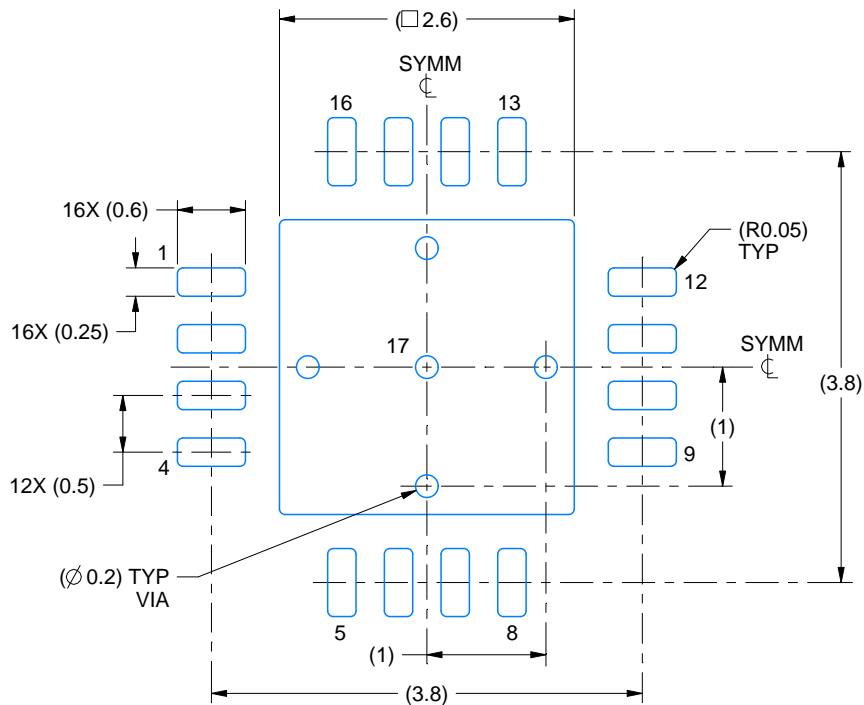

LAND PATTERN EXAMPLE
EXPOSED METAL SHOWN
SCALE:15X

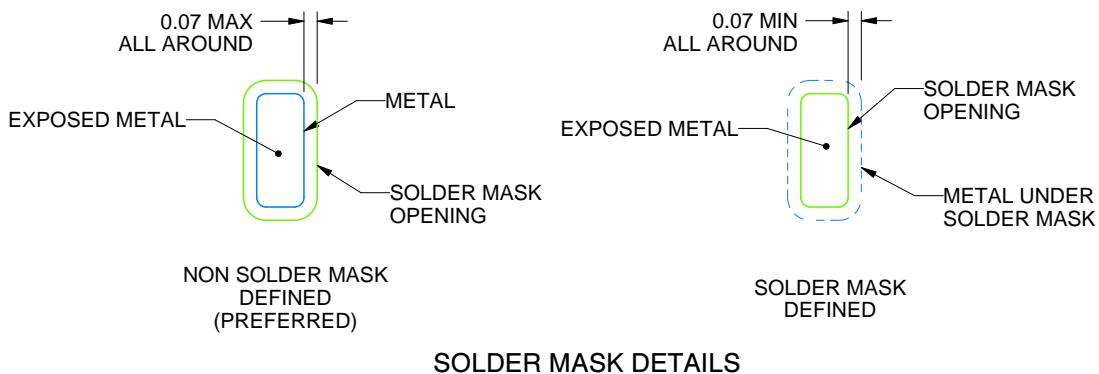

SOLDER MASK DETAILS

4214978/B 01/2017

NOTES: (continued)

4. This package is designed to be soldered to a thermal pad on the board. For more information, see Texas Instruments literature number SLUA271 (www.ti.com/lit/slua271).
5. Vias are optional depending on application, refer to device data sheet. If any vias are implemented, refer to their locations shown on this view. It is recommended that vias under paste be filled, plugged or tented.

EXAMPLE STENCIL DESIGN

RGH0016A

WQFN - 0.8 mm max height

PLASTIC QUAD FLATPACK - NO LEAD

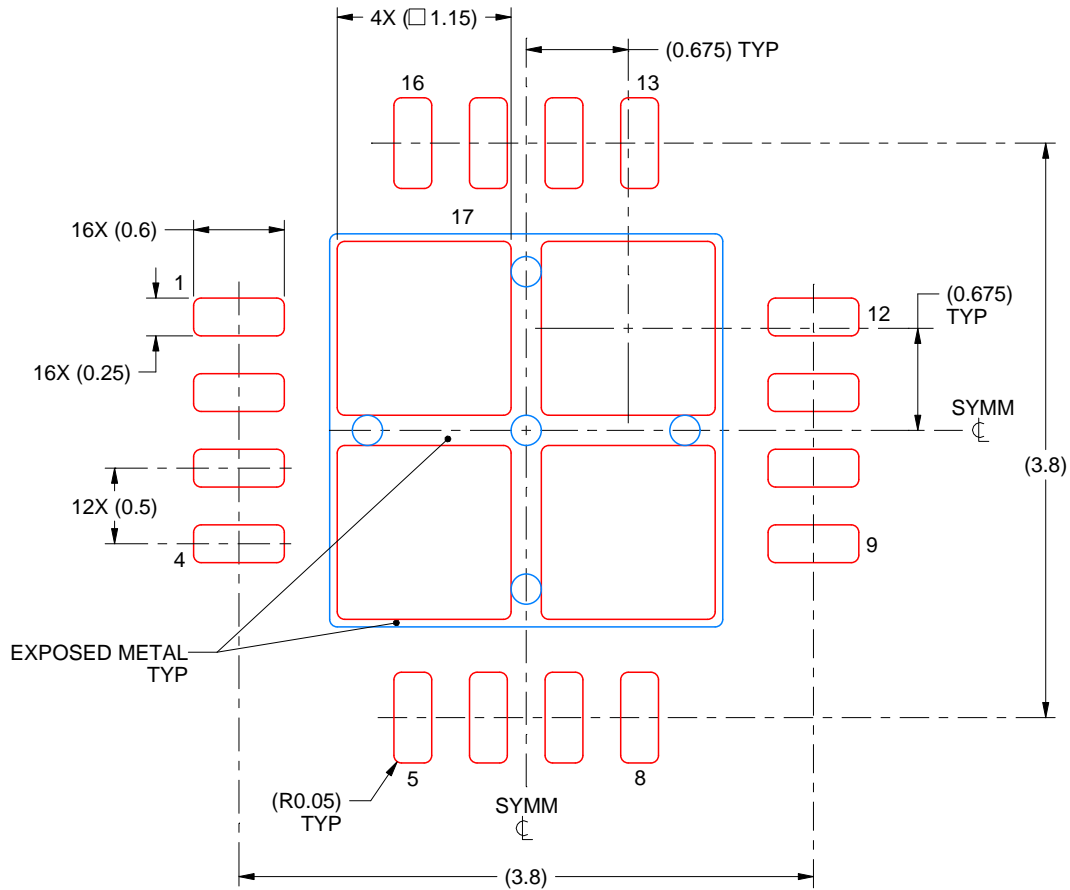

SOLDER PASTE EXAMPLE
BASED ON 0.125 mm THICK STENCIL

EXPOSED PAD 17
78% PRINTED SOLDER COVERAGE BY AREA UNDER PACKAGE
SCALE:20X

4214978/B 01/2017

NOTES: (continued)

6. Laser cutting apertures with trapezoidal walls and rounded corners may offer better paste release. IPC-7525 may have alternate design recommendations.

IMPORTANT NOTICE

Texas Instruments Incorporated (TI) reserves the right to make corrections, enhancements, improvements and other changes to its semiconductor products and services per JESD46, latest issue, and to discontinue any product or service per JESD48, latest issue. Buyers should obtain the latest relevant information before placing orders and should verify that such information is current and complete.

TI's published terms of sale for semiconductor products (<http://www.ti.com/sc/docs/stdterms.htm>) apply to the sale of packaged integrated circuit products that TI has qualified and released to market. Additional terms may apply to the use or sale of other types of TI products and services.

Reproduction of significant portions of TI information in TI data sheets is permissible only if reproduction is without alteration and is accompanied by all associated warranties, conditions, limitations, and notices. TI is not responsible or liable for such reproduced documentation. Information of third parties may be subject to additional restrictions. Resale of TI products or services with statements different from or beyond the parameters stated by TI for that product or service voids all express and any implied warranties for the associated TI product or service and is an unfair and deceptive business practice. TI is not responsible or liable for any such statements.

Buyers and others who are developing systems that incorporate TI products (collectively, "Designers") understand and agree that Designers remain responsible for using their independent analysis, evaluation and judgment in designing their applications and that Designers have full and exclusive responsibility to assure the safety of Designers' applications and compliance of their applications (and of all TI products used in or for Designers' applications) with all applicable regulations, laws and other applicable requirements. Designer represents that, with respect to their applications, Designer has all the necessary expertise to create and implement safeguards that (1) anticipate dangerous consequences of failures, (2) monitor failures and their consequences, and (3) lessen the likelihood of failures that might cause harm and take appropriate actions. Designer agrees that prior to using or distributing any applications that include TI products, Designer will thoroughly test such applications and the functionality of such TI products as used in such applications.

TI's provision of technical, application or other design advice, quality characterization, reliability data or other services or information, including, but not limited to, reference designs and materials relating to evaluation modules, (collectively, "TI Resources") are intended to assist designers who are developing applications that incorporate TI products; by downloading, accessing or using TI Resources in any way, Designer (individually or, if Designer is acting on behalf of a company, Designer's company) agrees to use any particular TI Resource solely for this purpose and subject to the terms of this Notice.

TI's provision of TI Resources does not expand or otherwise alter TI's applicable published warranties or warranty disclaimers for TI products, and no additional obligations or liabilities arise from TI providing such TI Resources. TI reserves the right to make corrections, enhancements, improvements and other changes to its TI Resources. TI has not conducted any testing other than that specifically described in the published documentation for a particular TI Resource.

Designer is authorized to use, copy and modify any individual TI Resource only in connection with the development of applications that include the TI product(s) identified in such TI Resource. NO OTHER LICENSE, EXPRESS OR IMPLIED, BY ESTOPPEL OR OTHERWISE TO ANY OTHER TI INTELLECTUAL PROPERTY RIGHT, AND NO LICENSE TO ANY TECHNOLOGY OR INTELLECTUAL PROPERTY RIGHT OF TI OR ANY THIRD PARTY IS GRANTED HEREIN, including but not limited to any patent right, copyright, mask work right, or other intellectual property right relating to any combination, machine, or process in which TI products or services are used. Information regarding or referencing third-party products or services does not constitute a license to use such products or services, or a warranty or endorsement thereof. Use of TI Resources may require a license from a third party under the patents or other intellectual property of the third party, or a license from TI under the patents or other intellectual property of TI.

TI RESOURCES ARE PROVIDED "AS IS" AND WITH ALL FAULTS. TI DISCLAIMS ALL OTHER WARRANTIES OR REPRESENTATIONS, EXPRESS OR IMPLIED, REGARDING RESOURCES OR USE THEREOF, INCLUDING BUT NOT LIMITED TO ACCURACY OR COMPLETENESS, TITLE, ANY EPIDEMIC FAILURE WARRANTY AND ANY IMPLIED WARRANTIES OF MERCHANTABILITY, FITNESS FOR A PARTICULAR PURPOSE, AND NON-INFRINGEMENT OF ANY THIRD PARTY INTELLECTUAL PROPERTY RIGHTS. TI SHALL NOT BE LIABLE FOR AND SHALL NOT DEFEND OR INDEMNIFY DESIGNER AGAINST ANY CLAIM, INCLUDING BUT NOT LIMITED TO ANY INFRINGEMENT CLAIM THAT RELATES TO OR IS BASED ON ANY COMBINATION OF PRODUCTS EVEN IF DESCRIBED IN TI RESOURCES OR OTHERWISE. IN NO EVENT SHALL TI BE LIABLE FOR ANY ACTUAL, DIRECT, SPECIAL, COLLATERAL, INDIRECT, PUNITIVE, INCIDENTAL, CONSEQUENTIAL OR EXEMPLARY DAMAGES IN CONNECTION WITH OR ARISING OUT OF TI RESOURCES OR USE THEREOF, AND REGARDLESS OF WHETHER TI HAS BEEN ADVISED OF THE POSSIBILITY OF SUCH DAMAGES.

Unless TI has explicitly designated an individual product as meeting the requirements of a particular industry standard (e.g., ISO/TS 16949 and ISO 26262), TI is not responsible for any failure to meet such industry standard requirements.

Where TI specifically promotes products as facilitating functional safety or as compliant with industry functional safety standards, such products are intended to help enable customers to design and create their own applications that meet applicable functional safety standards and requirements. Using products in an application does not by itself establish any safety features in the application. Designers must ensure compliance with safety-related requirements and standards applicable to their applications. Designer may not use any TI products in life-critical medical equipment unless authorized officers of the parties have executed a special contract specifically governing such use. Life-critical medical equipment is medical equipment where failure of such equipment would cause serious bodily injury or death (e.g., life support, pacemakers, defibrillators, heart pumps, neurostimulators, and implantables). Such equipment includes, without limitation, all medical devices identified by the U.S. Food and Drug Administration as Class III devices and equivalent classifications outside the U.S.

TI may expressly designate certain products as completing a particular qualification (e.g., Q100, Military Grade, or Enhanced Product). Designers agree that it has the necessary expertise to select the product with the appropriate qualification designation for their applications and that proper product selection is at Designers' own risk. Designers are solely responsible for compliance with all legal and regulatory requirements in connection with such selection.

Designer will fully indemnify TI and its representatives against any damages, costs, losses, and/or liabilities arising out of Designer's non-compliance with the terms and provisions of this Notice.