



SGM8038-1/SGM8038-2 6μA, 145kHz, Rail-to-Rail I/O, High Precision Operational Amplifiers

GENERAL DESCRIPTION

The single SGM8038-1 and dual SGM8038-2 are high precision operational amplifiers which can operate from 1.4V to 5.5V single supply, while consuming only 6μA quiescent current per amplifier. They are capable of rail-to-rail input and output. Therefore, the SGM8038-1/2 are suitable for use in portable instrumentation and battery-powered equipment.

The SGM8038-1/2 are unity-gain stable, and feature a 145kHz gain-bandwidth product. They are designed to provide optimal performance in low-frequency systems, when monitoring battery current and conditioning sensor signal.

The SGM8038-1 is available in Green SOT-23-5, SC70-5 and SOIC-8 packages. The SGM8038-2 is available in Green SOT-23-8, SOIC-8 and TDFN-2x2-8L packages. They operate over an ambient temperature range of -40°C to +125°C.

FEATURES

- **Low Quiescent Current:** 6μA/Amplifier (TYP)
- **Low Offset Voltage:** 800μV (MAX) at $V_S = 5V$
- **Unity-Gain Stable**
- **Gain-Bandwidth Product:** 145kHz (TYP) at $V_S = 5V$
- **Rail-to-Rail Input and Output**
- **Supply Voltage Range:** 1.4V to 5.5V
- **-40°C to +125°C Operating Temperature Range**
- **Small Packaging:**
 - SGM8038-1 Available in Green SOT-23-5, SC70-5 and SOIC-8 Packages
 - SGM8038-2 Available in Green SOT-23-8, SOIC-8 and TDFN-2x2-8L Packages

APPLICATIONS

- Battery-Powered Equipment
- Temperature Measurements
- Tollbooth Tags
- Wearable Devices

TYPICAL APPLICATION

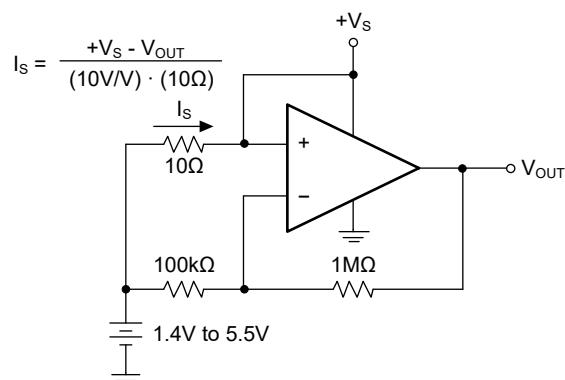

Figure 1. High-side Battery Current Sensor

PACKAGE/ORDERING INFORMATION

MODEL	PACKAGE DESCRIPTION	SPECIFIED TEMPERATURE RANGE	ORDERING NUMBER	PACKAGE MARKING	PACKING OPTION
SGM8038-1	SOT-23-5	-40°C to +125°C	SGM8038-1XN5G/TR	RD4XX	Tape and Reel, 3000
	SC70-5	-40°C to +125°C	SGM8038-1XC5G/TR	RDDXX	Tape and Reel, 3000
	SOIC-8	-40°C to +125°C	SGM8038-1XS8G/TR	SGM 80381XS8 XXXXX	Tape and Reel, 4000
SGM8038-2	SOT-23-8	-40°C to +125°C	SGM8038-2XN8G/TR	CVDXX	Tape and Reel, 3000
	SOIC-8	-40°C to +125°C	SGM8038-2XS8G/TR	SGM 80382XS8 XXXXX	Tape and Reel, 4000
	TDFN-2 \times 2-8L	-40°C to +125°C	SGM8038-2XTDE8G/TR	CVC XXXX	Tape and Reel, 3000

MARKING INFORMATION

NOTE: XX = Date Code. XXXX = Date Code and Trace Code. XXXXX = Date Code, Trace Code and Vendor Code.

SOT-23-5/SC70-5/SOT-23-8

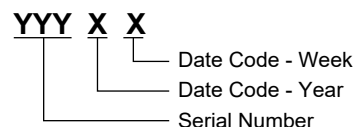

SOIC-8

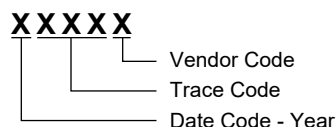

TDFN-2 \times 2-8L

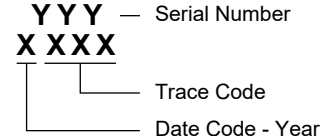

Green (RoHS & HSF): SG Micro Corp defines "Green" to mean Pb-Free (RoHS compatible) and free of halogen substances. If you have additional comments or questions, please contact your SGMICRO representative directly.

ABSOLUTE MAXIMUM RATINGS

Supply Voltage, +V _S to -V _S	6V
Analog Inputs (V _{IN+} , V _{IN-}).....	(-V _S) - 0.3V to (+V _S) + 0.3V
Differential Input Voltage.....	(-V _S) - (+V _S)
Junction Temperature.....	+150°C
Storage Temperature Range.....	-65°C to +150°C
Lead Temperature (Soldering, 10s).....	+260°C
ESD Susceptibility	
HBM.....	5000V
CDM.....	1000V

RECOMMENDED OPERATING CONDITIONS

Operating Temperature Range.....	-40°C to +125°C
----------------------------------	-----------------

OVERSTRESS CAUTION

Stresses beyond those listed in Absolute Maximum Ratings may cause permanent damage to the device. Exposure to absolute maximum rating conditions for extended periods

may affect reliability. Functional operation of the device at any conditions beyond those indicated in the Recommended Operating Conditions section is not implied.

ESD SENSITIVITY CAUTION

This integrated circuit can be damaged if ESD protections are not considered carefully. SGMICRO recommends that all integrated circuits be handled with appropriate precautions. Failure to observe proper handling and installation procedures can cause damage. ESD damage can range from subtle performance degradation to complete device failure. Precision integrated circuits may be more susceptible to damage because even small parametric changes could cause the device not to meet the published specifications.

DISCLAIMER

SG Micro Corp reserves the right to make any change in circuit design, or specifications without prior notice.

PIN CONFIGURATIONS

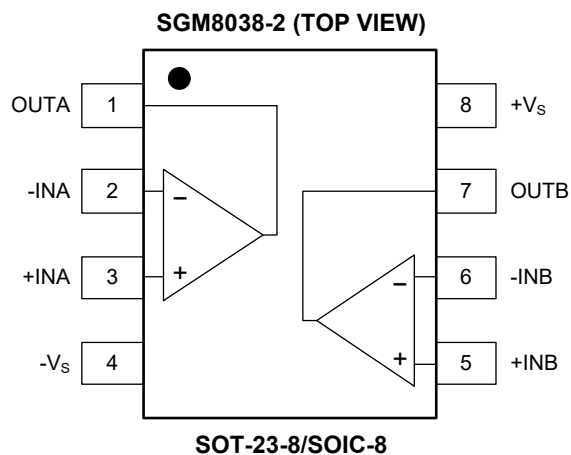
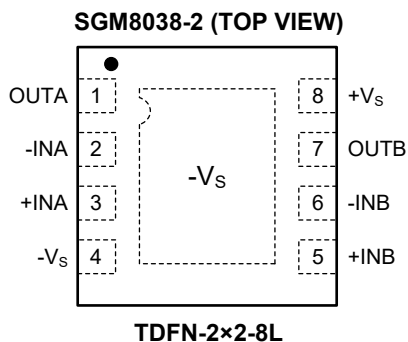
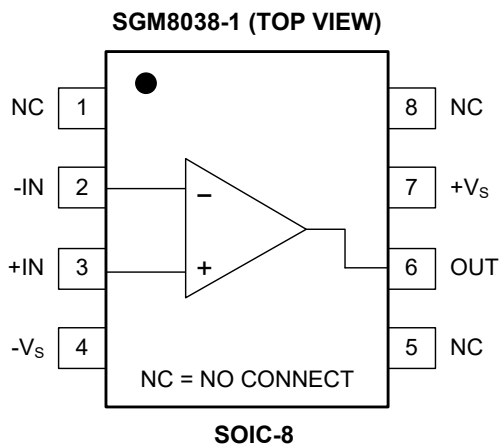
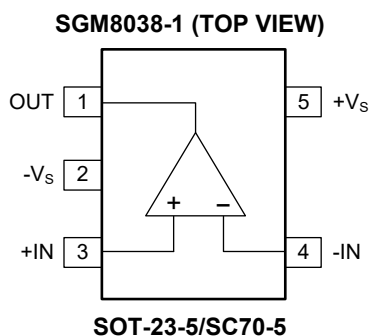

NOTE: For the TDFN-2x2-8L package, connect thermal die pad to -Vs. Connect it to -Vs plane to maximize thermal performance.

ELECTRICAL CHARACTERISTICS

($V_S = 1.4V$ to $5.5V$, $V_{CM} = V_S/2$ and $R_L = 50k\Omega$ ⁽¹⁾ connect to $V_S/2$, Full = $-40^\circ C$ to $+125^\circ C$, typical values are at $T_A = +25^\circ C$, unless otherwise noted.)

PARAMETER	SYMBOL	CONDITIONS	TEMP	MIN	TYP	MAX	UNITS
Input Characteristics							
Input Offset Voltage	V_{OS}	$V_S = 1.4V$	+25°C		240	800	μV
			Full			1500	
		$V_S = 5V$	+25°C		100	800	
			Full			1500	
		$V_S = 5.5V$	+25°C		100	800	
			Full			1500	
Input Offset Voltage Drift	$\Delta V_{OS}/\Delta T$	$V_S = 1.4V$	Full		4		$\mu V/^\circ C$
		$V_S = 5V$	Full		3		
		$V_S = 5.5V$	Full		3		
Input Bias Current	I_B		+25°C		2	180	pA
			Full			3500	
Input Offset Current	I_{OS}		+25°C		2	180	pA
			Full			1500	
Input Common Mode Voltage Range	V_{CM}			$(-V_S) - 0.1$		$(+V_S) + 0.1$	V
Common Mode Rejection Ratio	CMRR	$V_S = 5V, V_{CM} = -0.1V$ to $5.1V$	+25°C	70	94		dB
			Full	67			
		$V_S = 5V, V_{CM} = -0.1V$ to $4.0V$	+25°C	80	98		
			Full	77			
		$V_S = 5V, V_{CM} = 4.0V$ to $5.1V$	+25°C	59	80		
			Full	56			
Large-Signal Voltage Gain	A_{OL}	$V_S = 1.4V, R_L = 50k\Omega$ $(-V_S) + 0.1V < V_{OUT} < (+V_S) - 0.1V$	+25°C	90	110		dB
			Full	87			
		$V_S = 2.5V, R_L = 50k\Omega$ $(-V_S) + 0.1V < V_{OUT} < (+V_S) - 0.1V$	+25°C	96	120		
			Full	93			
		$V_S = 5V, R_L = 50k\Omega$ $(-V_S) + 0.1V < V_{OUT} < (+V_S) - 0.1V$	+25°C	103	125		
			Full	100			
Output Characteristics							
Output Voltage Swing from Rail		$R_L = 50k\Omega$	+25°C		2.5	6	mV
			Full			8	
Output Short-Circuit Current	I_{SC}	$V_S = 1.4V$	+25°C	1.2	2.5		mA
			Full	1			
		$V_S = 5V$	+25°C	24	35		
			Full	12			
Power Supply							
Supply Voltage	V_S			1.4		5.5	V
Quiescent Current/Amplifier	I_Q		+25°C		6	10	μA
			Full			12	
Power Supply Rejection Ratio	PSRR	$V_S = 1.4V$ to $5.5V, V_{CM} = 0.2V$	+25°C		8	50	$\mu V/V$
			Full			60	

NOTE: 1. Refer to Figure 2 and Figure 3.

ELECTRICAL CHARACTERISTICS (continued)

($V_S = 1.4V$ to $5.5V$, $V_{CM} = V_S/2$ and $R_L = 50k\Omega$ ⁽¹⁾ connect to $V_S/2$, Full = $-40^\circ C$ to $+125^\circ C$, typical values are at $T_A = +25^\circ C$, unless otherwise noted.)

PARAMETER	SYMBOL	CONDITIONS	TEMP	MIN	TYP	MAX	UNITS
Dynamic Performance ($C_L = 60pF$)							
Gain-Bandwidth Product	GBP	$V_S = 1.4V$	$+25^\circ C$		105		kHz
		$V_S = 2.5V$	$+25^\circ C$		130		
		$V_S = 5V$	$+25^\circ C$		145		
Slew Rate	SR	$V_S = 1.4V, V_{OUT} = 1V$ step	$+25^\circ C$		60		V/ms
		$V_S = 2.5V, V_{OUT} = 1V$ step	$+25^\circ C$		86		
		$V_S = 5V, V_{OUT} = 2V$ step	$+25^\circ C$		130		
Noise							
Input Voltage Noise		$f = 0.1Hz$ to $10Hz$	$+25^\circ C$		6		μV_{P-P}
Input Voltage Noise Density	e_n	$f = 1kHz$	$+25^\circ C$		110		nV/\sqrt{Hz}

NOTE: 1. Refer to Figure 2 and Figure 3.

TEST CIRCUITS

Figure 2 and Figure 3 show the AC and DC test circuits.

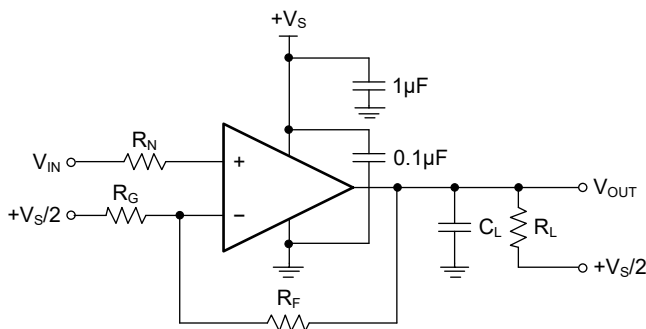

Figure 2. AC and DC Test Circuit for Most Non-Inverting Gain Configurations

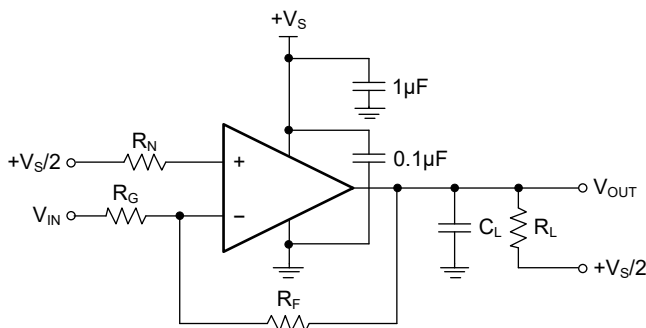
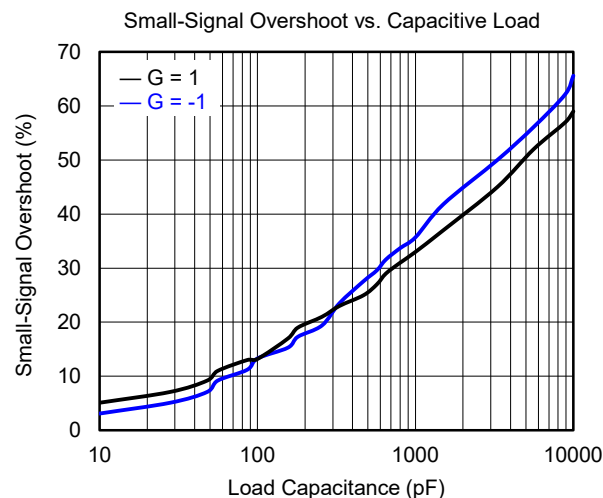
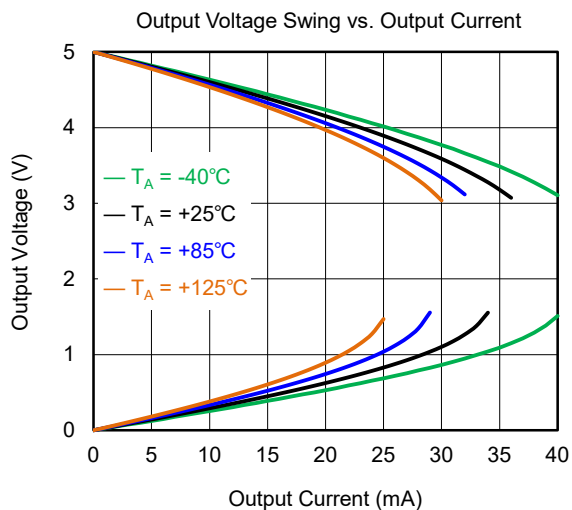
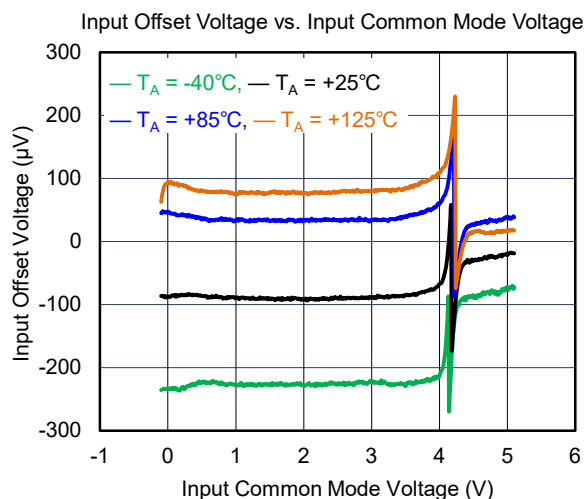
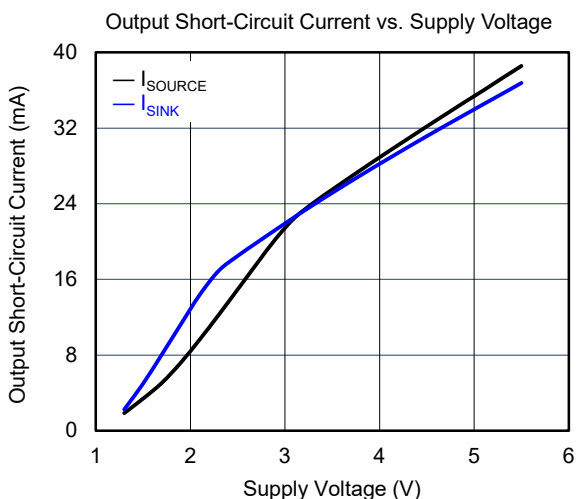
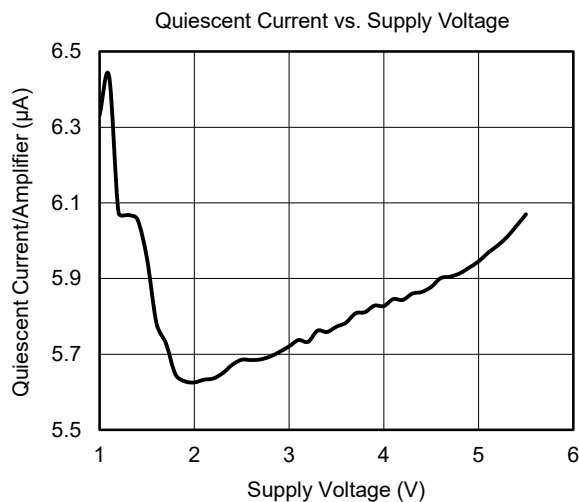
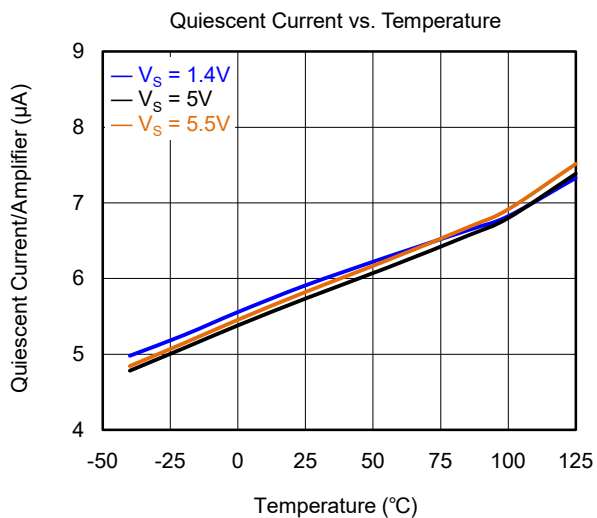

Figure 3. AC and DC Test Circuit for Most Inverting Gain Configurations

TYPICAL PERFORMANCE CHARACTERISTICS

At $T_A = +25^\circ\text{C}$, $V_S = 5\text{V}$, unless otherwise noted.



TYPICAL PERFORMANCE CHARACTERISTICS (continued)

At $T_A = +25^\circ\text{C}$, $V_S = 5\text{V}$, unless otherwise noted.

Large-Signal Step Response

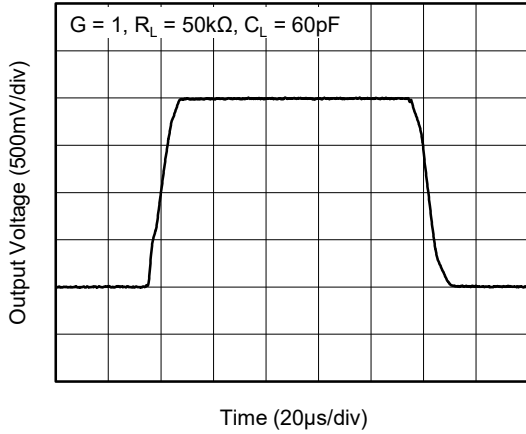

Small-Signal Step Response

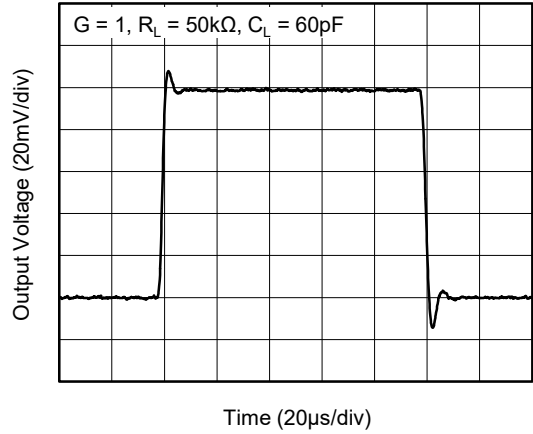

0.1Hz to 10Hz Input Voltage Noise

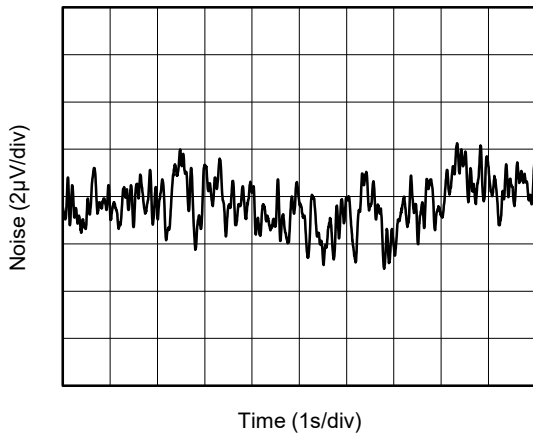

Input Voltage Noise Density vs. Frequency

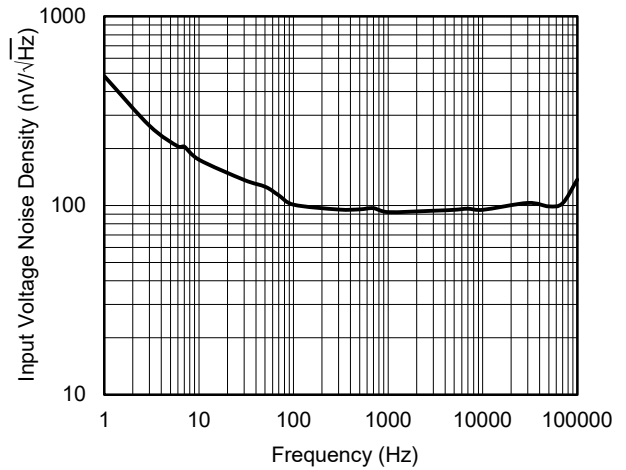

PSRR vs. Frequency (Referred-to-Input)

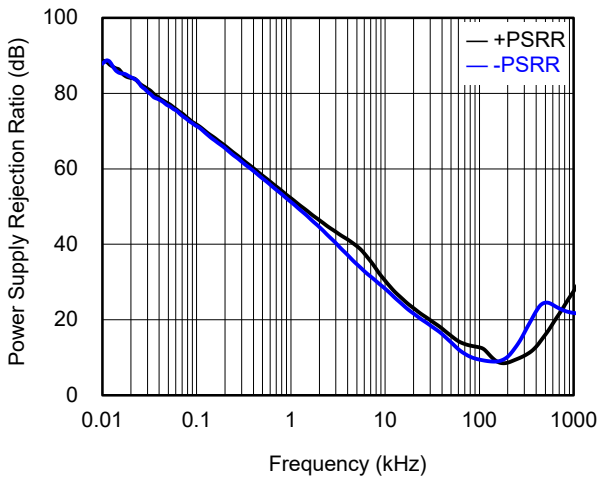

CMRR vs. Frequency (Referred-to-Input)

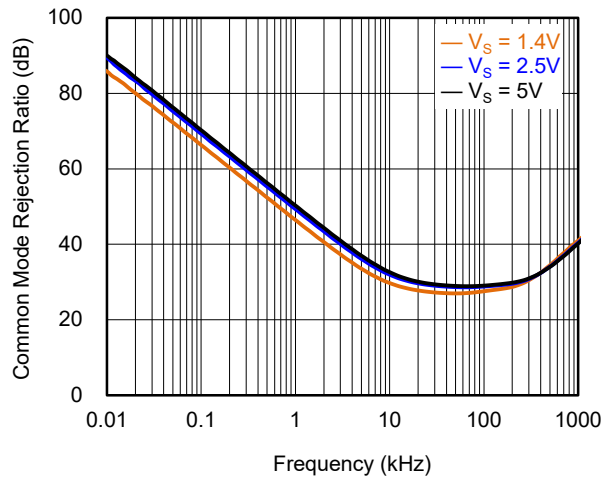

TYPICAL PERFORMANCE CHARACTERISTICS (continued)

At $T_A = +25^\circ\text{C}$, $V_S = 5\text{V}$, unless otherwise noted.

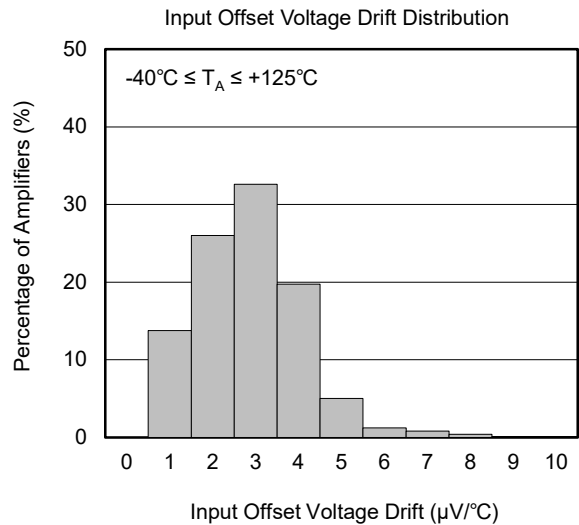
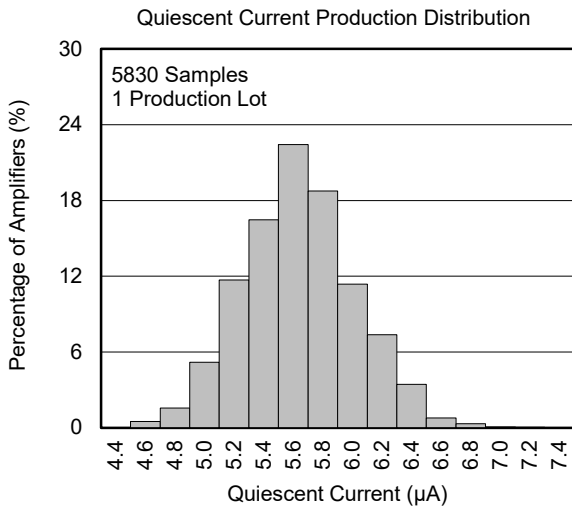
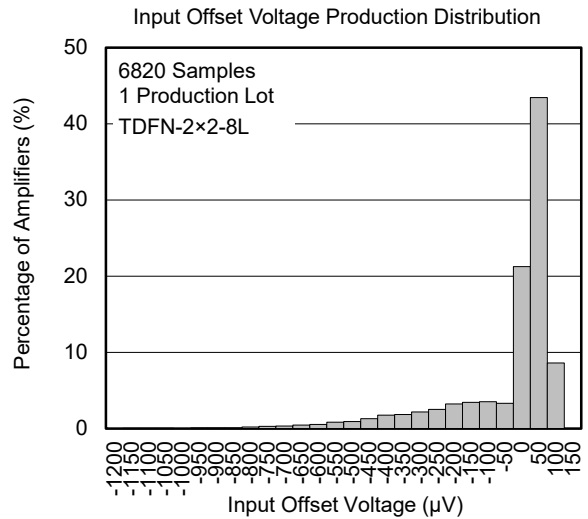
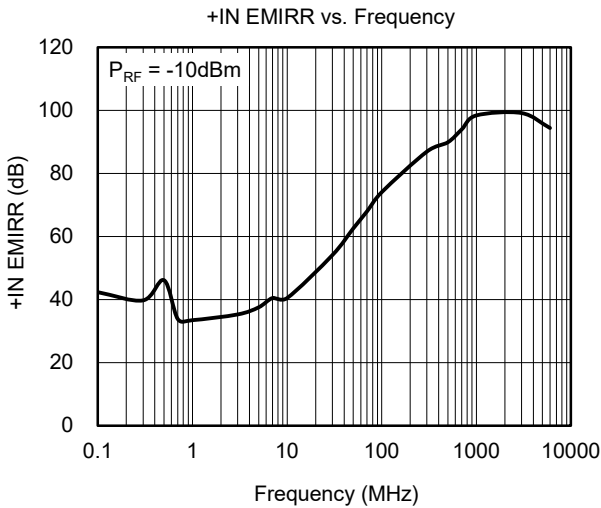
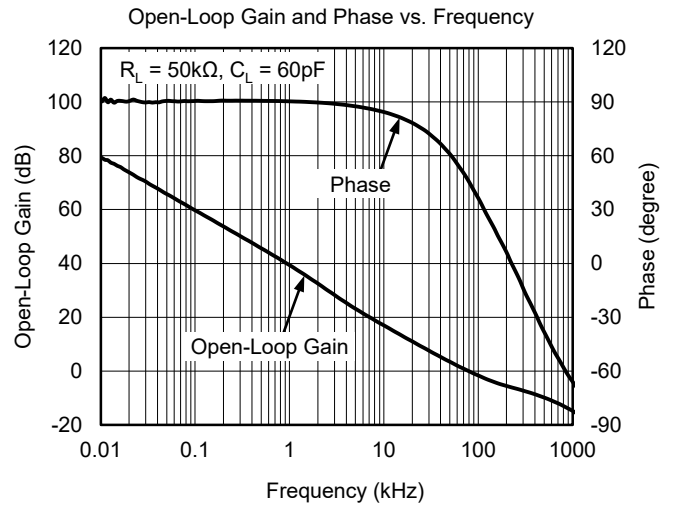
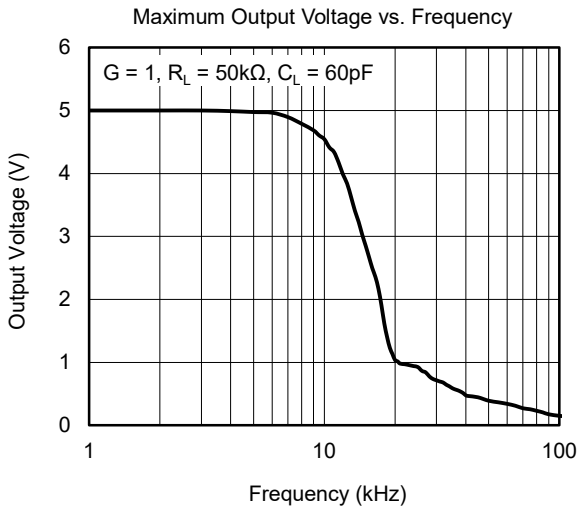

REVISION HISTORY

NOTE: Page numbers for previous revisions may differ from page numbers in the current version.

Changes from Original (JULY 2021) to REV.A

Page

Changed from product preview to production data.....	All
--	-----

PACKAGE OUTLINE DIMENSIONS

SOT-23-5

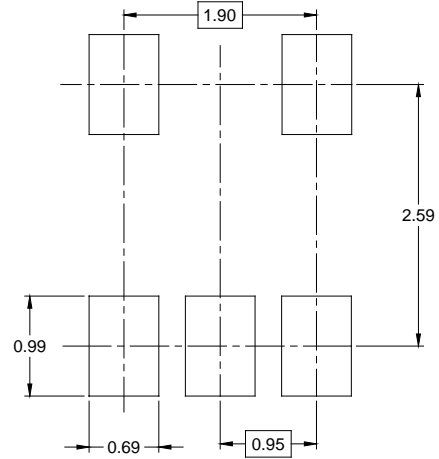
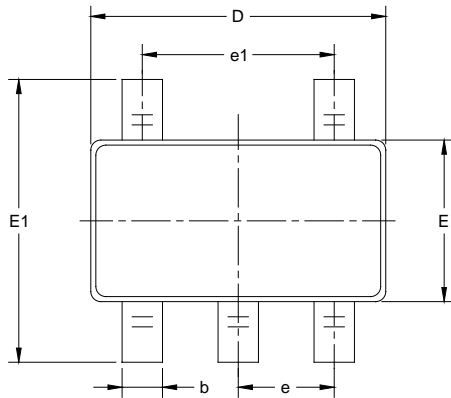

RECOMMENDED LAND PATTERN (Unit: mm)

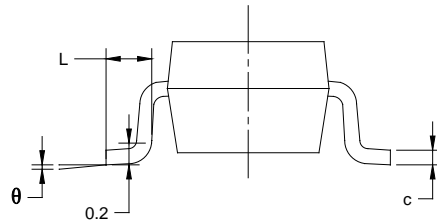
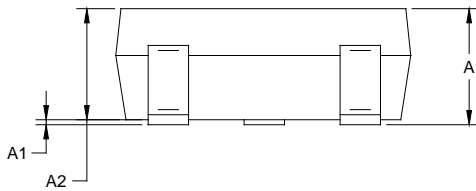

Symbol	Dimensions In Millimeters		Dimensions In Inches	
	MIN	MAX	MIN	MAX
A	1.050	1.250	0.041	0.049
A1	0.000	0.100	0.000	0.004
A2	1.050	1.150	0.041	0.045
b	0.300	0.500	0.012	0.020
c	0.100	0.200	0.004	0.008
D	2.820	3.020	0.111	0.119
E	1.500	1.700	0.059	0.067
E1	2.650	2.950	0.104	0.116
e	0.950 BSC		0.037 BSC	
e1	1.900 BSC		0.075 BSC	
L	0.300	0.600	0.012	0.024
θ	0°	8°	0°	8°

NOTES:

1. Body dimensions do not include mode flash or protrusion.
2. This drawing is subject to change without notice.

PACKAGE OUTLINE DIMENSIONS

SC70-5

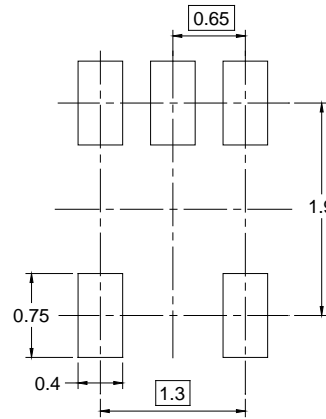
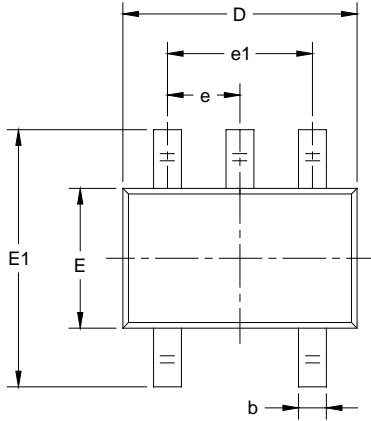

RECOMMENDED LAND PATTERN (Unit: mm)

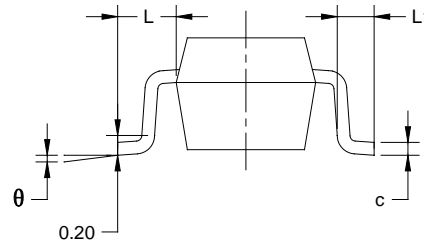
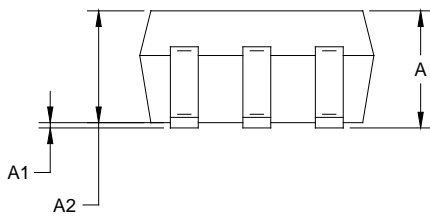

Symbol	Dimensions In Millimeters		Dimensions In Inches	
	MIN	MAX	MIN	MAX
A	0.800	1.100	0.031	0.043
A1	0.000	0.100	0.000	0.004
A2	0.800	1.000	0.031	0.039
b	0.150	0.350	0.006	0.014
c	0.080	0.220	0.003	0.009
D	2.000	2.200	0.079	0.087
E	1.150	1.350	0.045	0.053
E1	2.150	2.450	0.085	0.096
e	0.65 TYP		0.026 TYP	
e1	1.300 BSC		0.051 BSC	
L	0.525 REF		0.021 REF	
L1	0.260	0.460	0.010	0.018
θ	0°	8°	0°	8°

NOTES:
 1. Body dimensions do not include mode flash or protrusion.
 2. This drawing is subject to change without notice.

PACKAGE OUTLINE DIMENSIONS

SOT-23-8

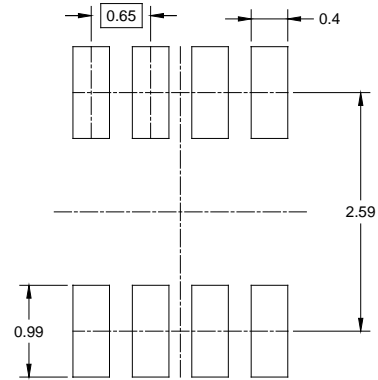
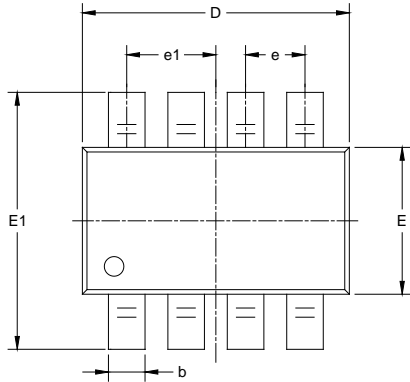

RECOMMENDED LAND PATTERN (Unit: mm)

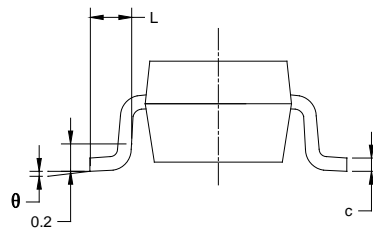
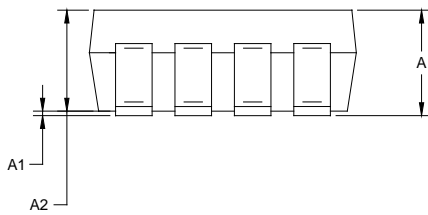

Symbol	Dimensions In Millimeters		Dimensions In Inches	
	MIN	MAX	MIN	MAX
A	1.050	1.250	0.041	0.049
A1	0.000	0.100	0.000	0.004
A2	1.050	1.150	0.041	0.045
b	0.300	0.500	0.012	0.020
c	0.100	0.200	0.004	0.008
D	2.820	3.020	0.111	0.119
E	1.500	1.700	0.059	0.067
E1	2.650	2.950	0.104	0.116
e	0.650 BSC		0.026 BSC	
e1	0.975 BSC		0.038 BSC	
L	0.300	0.600	0.012	0.024
θ	0°	8°	0°	8°

NOTES:

1. Body dimensions do not include mode flash or protrusion.
2. This drawing is subject to change without notice.

PACKAGE OUTLINE DIMENSIONS

TDFN-2x2-8L

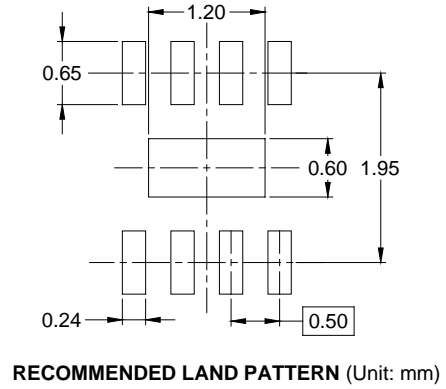
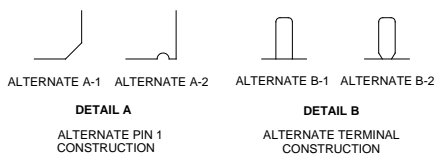
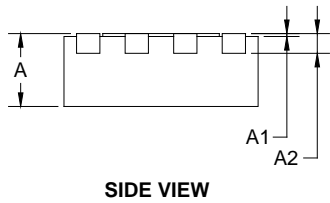
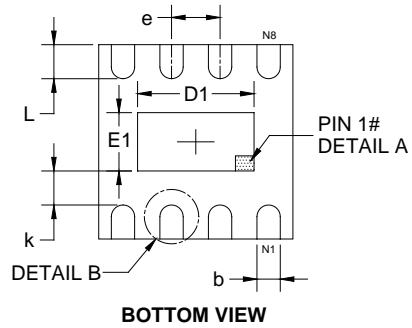
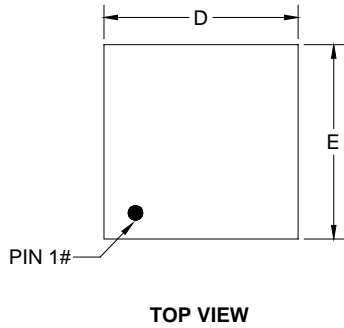

Symbol	Dimensions In Millimeters		
	MIN	MOD	MAX
A	0.700	0.750	0.800
A1	0.000	-	0.050
A2	0.203 REF		
D	1.900	2.000	2.100
E	1.900	2.000	2.100
D1	1.100	1.200	1.300
E1	0.500	0.600	0.700
b	0.180	-	0.300
e	0.500 TYP		
k	0.200 MIN		
L	0.250	0.350	0.450

NOTE: This drawing is subject to change without notice.

PACKAGE OUTLINE DIMENSIONS

SOIC-8

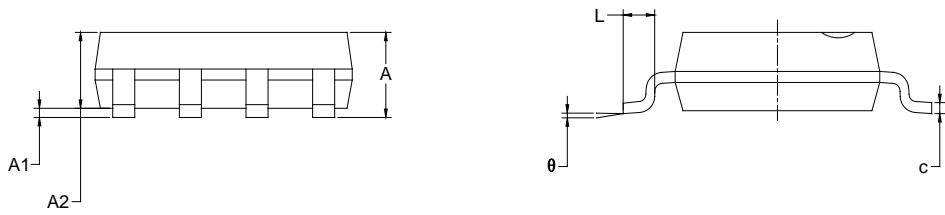
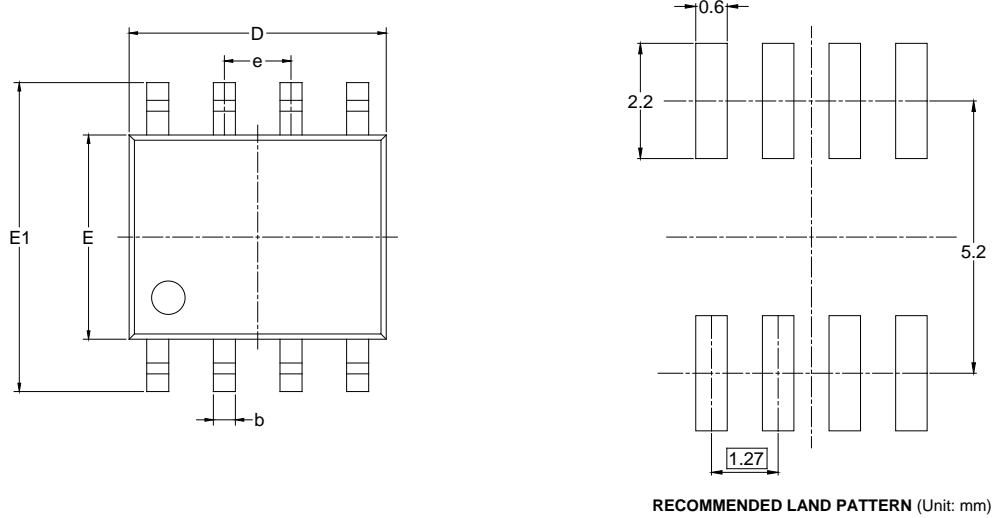

Symbol	Dimensions In Millimeters		Dimensions In Inches	
	MIN	MAX	MIN	MAX
A	1.350	1.750	0.053	0.069
A1	0.100	0.250	0.004	0.010
A2	1.350	1.550	0.053	0.061
b	0.330	0.510	0.013	0.020
c	0.170	0.250	0.006	0.010
D	4.700	5.100	0.185	0.200
E	3.800	4.000	0.150	0.157
E1	5.800	6.200	0.228	0.244
e	1.27 BSC		0.050 BSC	
L	0.400	1.270	0.016	0.050
θ	0°	8°	0°	8°

NOTES:
 1. Body dimensions do not include mode flash or protrusion.
 2. This drawing is subject to change without notice.

PACKAGE INFORMATION

TAPE AND REEL INFORMATION

REEL DIMENSIONS

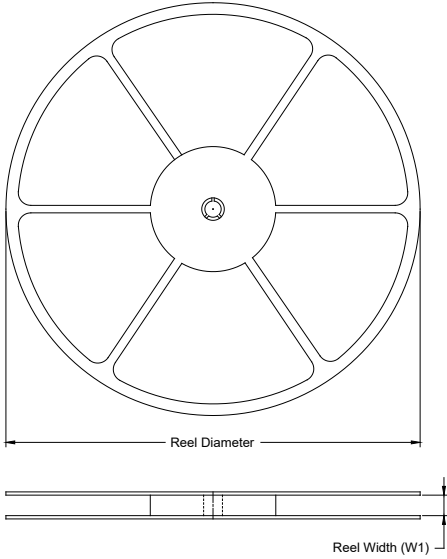

TAPE DIMENSIONS



NOTE: The picture is only for reference. Please make the object as the standard.

KEY PARAMETER LIST OF TAPE AND REEL

Package Type	Reel Diameter	Reel Width W1 (mm)	A0 (mm)	B0 (mm)	K0 (mm)	P0 (mm)	P1 (mm)	P2 (mm)	W (mm)	Pin1 Quadrant
SOT-23-5	7"	9.5	3.20	3.20	1.40	4.0	4.0	2.0	8.0	Q3
SC70-5	7"	9.5	2.25	2.55	1.20	4.0	4.0	2.0	8.0	Q3
SOT-23-8	7"	9.5	3.17	3.23	1.37	4.0	4.0	2.0	8.0	Q3
TDFN-2×2-8L	7"	9.5	2.30	2.30	1.10	4.0	4.0	2.0	8.0	Q1
SOIC-8	13"	12.4	6.40	5.40	2.10	4.0	8.0	2.0	12.0	Q1

D20001

PACKAGE INFORMATION

CARTON BOX DIMENSIONS



NOTE: The picture is only for reference. Please make the object as the standard.

KEY PARAMETER LIST OF CARTON BOX

Reel Type	Length (mm)	Width (mm)	Height (mm)	Pizza/Carton
7" (Option)	368	227	224	8
7"	442	410	224	18
13"	386	280	370	5

DD0002