

179938-1 ✓ ACTIVE



## Power Double Lock

TE Internal #: 179938-1

Housing, Plug, Wire-to-Wire, 3 Position, 6.5 mm [.255 in] Centerline,  
Wire & Cable, UL 94V-0, Power Double Lock, Rectangular Power  
Connectors

[View on TE.com >](#)

Connectors > Power Connectors > Rectangular Power > Rectangular Power Connectors > STD Temp Power Double Lock Plug

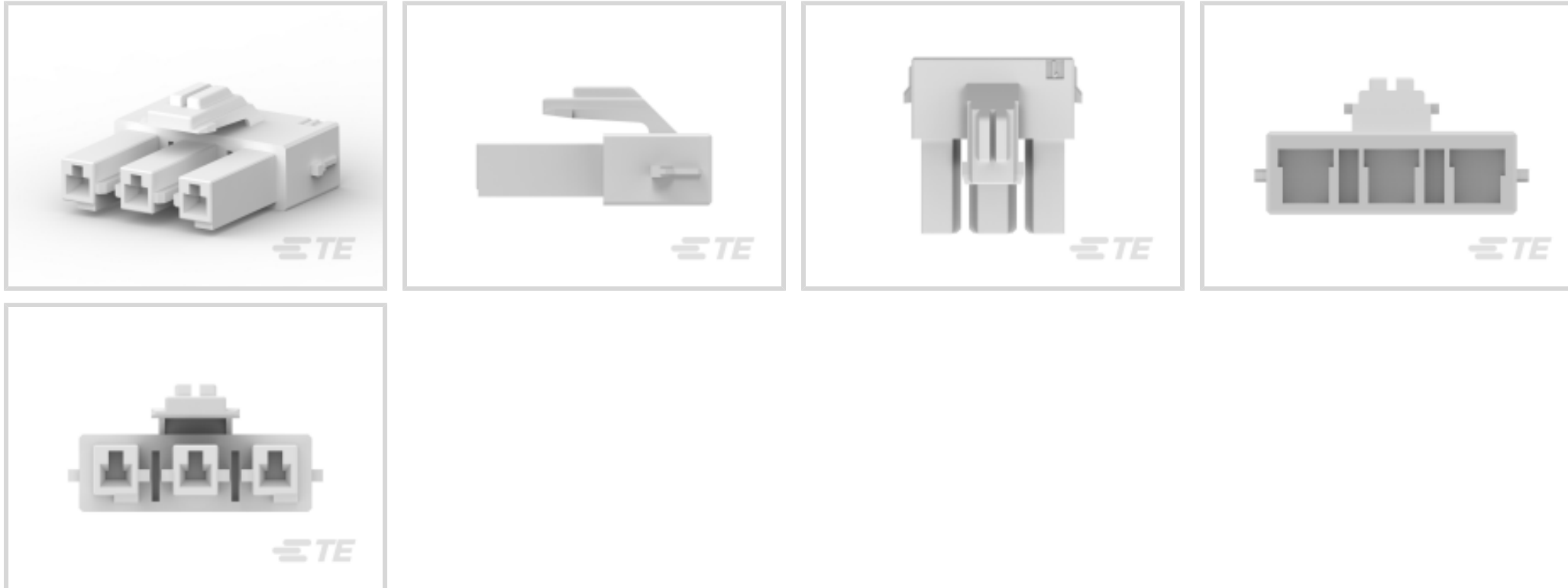

Rectangular Power Connector Type: **Housing**

Connector & Housing Type: **Plug**

Connector System: **Wire-to-Wire**

Number of Positions: **3**

Centerline (Pitch): **6.5 mm [.255 in]**

[All STD Temp Power Double Lock Plug \(66\)](#)

## Features

### Product Type Features

Compatible With Discrete Wire Type	Stranded
Rectangular Power Connector Type	Housing
Connector & Housing Type	Plug
Connector System	Wire-to-Wire
Sealable	No
Connector & Contact Terminates To	Wire & Cable

### Configuration Features

Number of Positions	3
Number of Power Positions	0
Number of Signal Positions	0
Number of Rows	1

### Electrical Characteristics



Operating Voltage	300 VAC
-------------------	---------

### Contact Features

Contact Layout	Inline
Contact Retention Within Housing	Without
Contact Type	Receptacle

### Termination Features

Termination Method to Wire & Cable	Crimp
------------------------------------	-------

### Mechanical Attachment

Connector Mounting Type	Cable Mount (Free-Hanging)
-------------------------	----------------------------

### Housing Features

Centerline (Pitch)	6.5 mm [.255 in]
Housing Color	Natural
Housing Material	Nylon 6/6

### Usage Conditions

Operating Temperature Range	-30 – 105 °C [-22 – 221 °F]
-----------------------------	-----------------------------

### Operation/Application

Circuit Application	Power & Signal
---------------------	----------------

### Industry Standards

Compatible With Agency/Standards Products	CNR, USR, VDE
Compatible With Approved Standards Products	CSA/C22.2 No. 182.3-M1987, UL 1977
UL Flammability Rating	UL 94V-0
Glow Wire Rating	Standard Part - Not Glow Wire

### Packaging Features

Packaging Quantity	150
Packaging Method	Bag

### Product Compliance

[For compliance documentation, visit the product page on TE.com>](#)

EU RoHS Directive 2011/65/EU	Compliant
EU ELV Directive 2000/53/EC	Compliant
China RoHS 2 Directive MIIT Order No 32, 2016	No Restricted Materials Above Threshold
EU REACH Regulation (EC) No. 1907/2006	



Current ECHA Candidate List: JUNE 2024 (241)  
 Candidate List Declared Against: JUNE 2024 (241)  
 Does not contain REACH SVHC

Halogen Content

Low Halogen - Br, Cl, F, I < 900 ppm per homogenous material. Also BFR/CFR/PVC Free

Solder Process Capability

Not applicable for solder process capability

Product Compliance Disclaimer

This information is provided based on reasonable inquiry of our suppliers and represents our current actual knowledge based on the information they provided. This information is subject to change. The part numbers that TE has identified as EU RoHS compliant have a maximum concentration of 0.1% by weight in homogenous materials for lead, hexavalent chromium, mercury, PBB, PBDE, DBP, BBP, DEHP, DIBP, and 0.01% for cadmium, or qualify for an exemption to these limits as defined in the Annexes of Directive 2011/65/EU (RoHS2). Finished electrical and electronic equipment products will be CE marked as required by Directive 2011/65/EU. Components may not be CE marked. Additionally, the part numbers that TE has identified as EU ELV compliant have a maximum concentration of 0.1% by weight in homogenous materials for lead, hexavalent chromium, and mercury, and 0.01% for cadmium, or qualify for an exemption to these limits as defined in the Annexes of Directive 2000/53/EC (ELV). Regarding the REACH Regulation, the information TE provides on SVHC in articles for this part number is based on the latest European Chemicals Agency (ECHA) 'Guidance on requirements for substances in articles' posted at this URL: <https://echa.europa.eu/guidance-documents/guidance-on-reach>

## Compatible Parts



TE Part # CAT-P87024-R2435  
Power Double Lock Receptacle

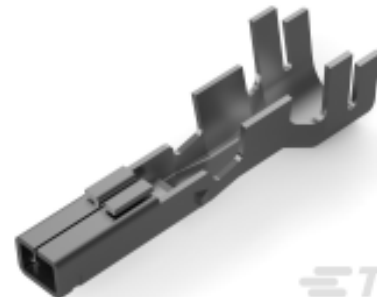

TE Part # 179593-1  
AMP POWER D/LOCK RECCONT. L/P



TE Part # 917745-1  
AMP POWER D/L TAB HDR ASY 2P V



TE Part # 179592-1  
AMP POWER D/LOCK REC CONT. L/P



TE Part # 179592-2  
POWER D/LOCK REC CONT. H/P L/P



TE Part # 179593-2  
POWER D/LOCK REC CONT. H/P L/P



TE Part # 179846-1  
AMP POWER D/LOCK T/HDR ASSY 3P



TE Part # 368570-1  
PDL 3P PLUG 6.5(GWT) NAT





TE Part # 1-179846-1  
PDL 3P HDR 6.5 SR V/T ASSY NAT

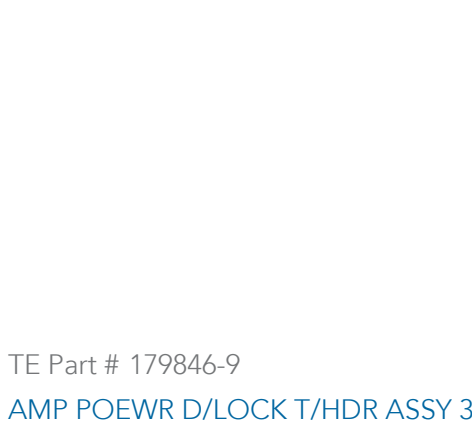

TE Part # 1-179846-9  
PDL 3P HDR 6.5 SR V/T ASSY BLK



TE Part # 179846-9  
AMP POWER D/LOCK T/HDR ASSY 3P



TE Part # 179857-1  
AMP POWER D/LOCK TAB HDR 3P V

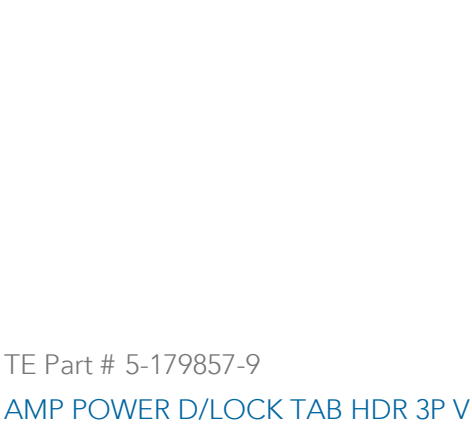

TE Part # 5-179857-9  
AMP POWER D/LOCK TAB HDR 3P V

Also in the Series | **Power Double Lock**



Connector Contacts(24)



Connector Hardware(14)



Insertion & Extraction Tools(2)



Rectangular Power Connectors(283)

Customers Also Bought



TE Part #179939-1  
POWER D/LOCK PLUG HSG 4P /6.5



TE Part #177914-2  
AMP POWER DBL LOCK REC (S)

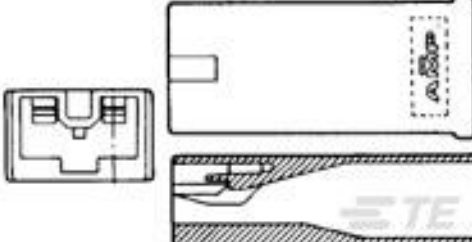

TE Part #179970-4  
PL EXII 250 REC HSG 1P NYLON YELLOW



TE Part #175057-2  
250 PL EX FLAG REC. 18-12AWG PTBR



TE Part #1-176497-1  
250 HSG. PL EX FLAG REC. NAT



TE Part #173722-1  
187 PL EX REC. 26-20AWG PTBR



TE Part #1981972-1  
GIC2.5W PLUG HOUSING 12POS (2-ROW) NAT



TE Part #1-2174298-2  
5mm POWER KEY 3P HDR ASSEMBLY



## Documents

### Product Drawings

[AMP POWER DBL LOCK PLUG HSG 3P](#)

English

### CAD Files

[3D PDF](#)

3D

Customer View Model

[ENG\\_CVM\\_CVM\\_179938-1\\_G.2d\\_dxf.zip](#)

English

Customer View Model

[ENG\\_CVM\\_CVM\\_179938-1\\_G.3d\\_igs.zip](#)

English

Customer View Model

[ENG\\_CVM\\_CVM\\_179938-1\\_G.3d\\_stp.zip](#)

English

By downloading the CAD file I accept and agree to the [Terms and Conditions](#) of use.

### Datasheets & Catalog Pages

[SOFT\\_SHELL\\_PIN\\_AND\\_SOCKET\\_CONNECTORS\\_CATALOG](#)

English

### Product Specifications

[Application Specification](#)

English

### Agency Approvals

[UL](#)

English