

# ESP32-S3 Series

## Datasheet

2.4 GHz Wi-Fi + Bluetooth<sup>®</sup> LE SoC

Supporting IEEE 802.11b/g/n (2.4 GHz Wi-Fi) and Bluetooth<sup>®</sup> 5 (LE)

### Including:

ESP32-S3

ESP32-S3FN8

ESP32-S3R2

ESP32-S3R8

ESP32-S3R8V

ESP32-S3FH4R2



Version 1.1  
Espressif Systems  
Copyright © 2022

# Product Overview

ESP32-S3 is a low-power MCU-based system-on-chip (SoC) that supports 2.4 GHz Wi-Fi and Bluetooth® Low Energy (Bluetooth LE). It consists of high-performance dual-core microprocessor (Xtensa® 32-bit LX7), a low power coprocessor, a Wi-Fi baseband, a Bluetooth LE baseband, RF module, and peripherals. The block diagram of the SoC is shown below.

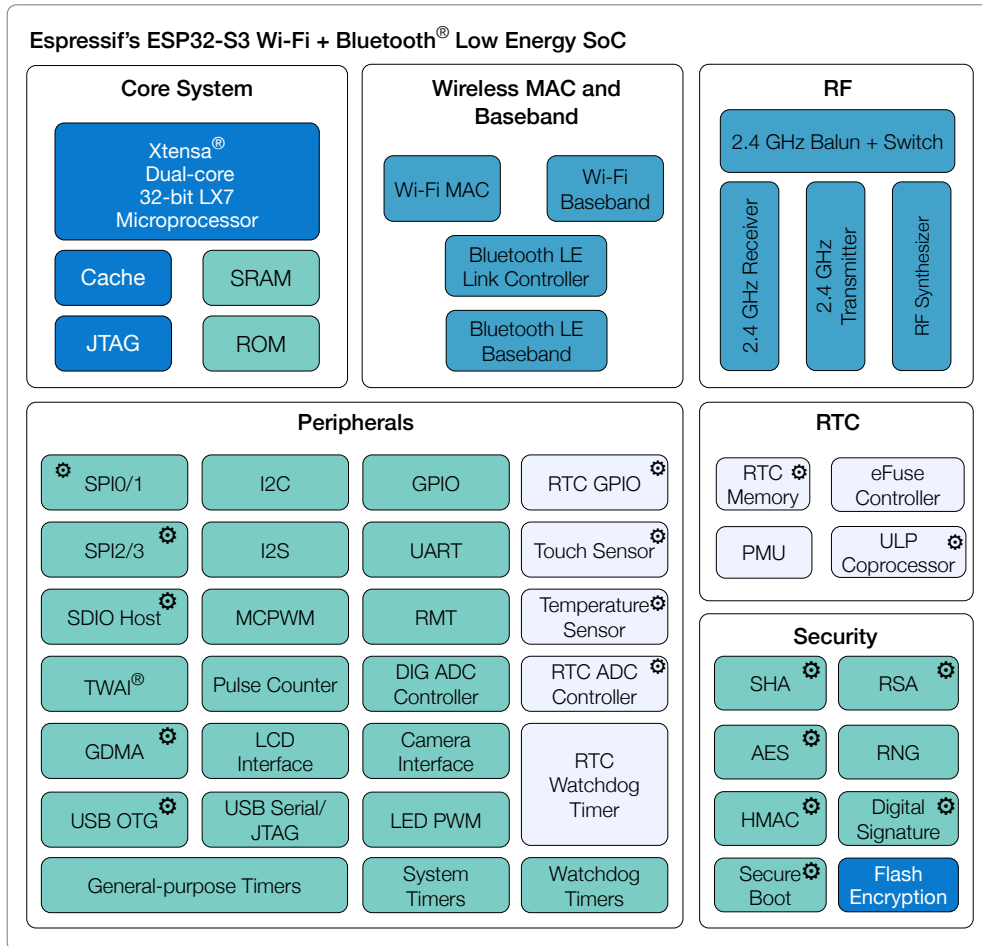

**Modules having power in specific power modes:**

- Active
- Active and Modem-sleep
- Active, Modem-sleep, and Light-sleep;  optional in Light-sleep
- all modes;  optional in Deep-sleep

Figure 1: Block Diagram of ESP32-S3

## Solution Highlights

- **A complete Wi-Fi subsystem** that complies with IEEE 802.11b/g/n protocol and supports Station, SoftAP, and SoftAP + Station modes
- **A Bluetooth LE subsystem** that supports features of Bluetooth 5 and Bluetooth mesh
- **Xtensa® 32-bit LX7 dual-core processor** with a five-stage pipeline that operates at up to 240 MHz
  - A 128-bit data bus and dedicated SIMD instructions to provide high computing

- performance
  - Efficient L1 cache to improve execution of external memory
  - Single-precision floating-point unit (FPU) to accelerate computing
- **Highly-integrated RF module** that provides industry-leading power and RF performance
- **State-of-the-art power management** designed for a wide range of applications with its multiple low-power modes. The ULP coprocessor can operate in ultra-low-power mode.
- **Powerful storage capacities** ensured by 512 KB SRAM and 384 KB ROM on the chip, and SPI, Dual SPI, Quad SPI, Octal SPI, QPI, and OPI

interfaces that allow connection to flash and external RAM

- **Reliable security features** ensured by
  - Cryptographic hardware accelerators that support AES-128/256, Hash, RSA, HMAC, digital signature, and secure boot
  - Random number generator
  - Permission control on accessing internal and external memory
  - External memory encryption and decryption
- **Rich set of peripheral interfaces and GPIOs**, ideal for various scenarios and complex applications

## Features

### Wi-Fi

- IEEE 802.11 b/g/n-compliant
- Supports 20 MHz, 40 MHz bandwidth in 2.4 GHz band
- 1T1R mode with data rate up to 150 Mbps
- Wi-Fi Multimedia (WMM)
- TX/RX A-MPDU, TX/RX A-MSDU
- Immediate Block ACK
- Fragmentation and defragmentation
- Automatic Beacon monitoring (hardware TSF)
- 4 × virtual Wi-Fi interfaces
- Simultaneous support for Infrastructure BSS in Station, SoftAP, or Station + SoftAP modes  
Note that when ESP32-S3 scans in Station mode, the SoftAP channel will change along with the Station channel
- Antenna diversity
- 802.11mc FTM
- External PA is supported

- High power mode (20 dBm, share the same PA with Wi-Fi)
- Speed: 125 Kbps, 500 Kbps, 1 Mbps, 2 Mbps
- Advertising extensions
- Multiple advertisement sets
- Channel selection algorithm #2
- Internal co-existence mechanism between Wi-Fi and Bluetooth to share the same antenna

### CPU and Memory

- Xtensa® dual-core 32-bit LX7 microprocessor, up to 240 MHz
- CoreMark® score:
  - 1 core at 240 MHz: 613.86 CoreMark; 2.56 CoreMark/MHz
  - 2 cores at 240 MHz: 1181.60 CoreMark; 4.92 CoreMark/MHz
- 128-bit data bus and SIMD commands
- 384 KB ROM
- 512 KB SRAM
- 16 KB SRAM in RTC
- SPI, Dual SPI, Quad SPI, Octal SPI, QPI and OPI

### Bluetooth

- Bluetooth LE: Bluetooth 5, Bluetooth mesh

interfaces that allow connection to multiple flash and external RAM

- Flash controller with cache is supported
- Flash in-Circuit Programming (ICP) is supported

### Advanced Peripheral Interfaces

- 45 × programmable GPIOs
- Digital interfaces:
  - 4 × SPI
  - 1 × LCD interface (8-bit ~16-bit parallel RGB, I8080 and MOTO6800), supporting conversion between RGB565, YUV422, YUV420 and YUV411
  - 1 × DVP 8-bit ~16-bit camera interface
  - 3 × UART
  - 2 × I2C
  - 2 × I2S
  - 1 × RMT (TX/RX)
  - 1 × pulse counter
  - LED PWM controller, up to 8 channels
  - 1 × full-speed USB OTG
  - 1 × USB Serial/JTAG controller
  - 2 × MCPWM
  - 1 × SDIO host controller with 2 slots
  - General DMA controller (GDMA), with 5 transmit channels and 5 receive channels
  - 1 × TWAI<sup>®</sup> controller, compatible with ISO 11898-1 (CAN Specification 2.0)

- Analog interfaces:
  - 2 × 12-bit SAR ADCs, up to 20 channels
  - 1 × temperature sensor
  - 14 × touch sensing IOs
- Timers:
  - 4 × 54-bit general-purpose timers
  - 1 × 52-bit system timer
  - 3 × watchdog timers

### Low Power Management

- Power Management Unit with five power modes
- Ultra-Low-Power (ULP) coprocessors:
  - ULP-RISC-V coprocessor
  - ULP-FSM coprocessor

### Security

- Secure boot
- Flash encryption
- 4-Kbit OTP, up to 1792 bits for users
- Cryptographic hardware acceleration:
  - AES-128/256 (FIPS PUB 197)
  - Hash (FIPS PUB 180-4)
  - RSA
  - Random Number Generator (RNG)
  - HMAC
  - Digital signature

## Applications (A Non-exhaustive List)

With low power consumption, ESP32-S3 is an ideal choice for IoT devices in the following areas:

- [Smart Home](#)
  - Light control
  - Smart button
  - Smart plug
- [Industrial Automation](#)
  - Industrial robot
  - Mesh network
  - Human machine interface (HMI)
- [Health Care](#)
  - Health monitor

- Baby monitor
- [Consumer Electronics](#)
  - Smart watch and bracelet
  - Over-the-top (OTT) devices
  - Wi-Fi and bluetooth speaker
  - Logger toys and proximity sensing toys
- Smart Agriculture
  - Smart greenhouse
  - Smart irrigation
  - Agriculture robot
- Retail and Catering
  - POS machines
  - Service robot
- Audio Device
  - Internet music players
  - Live streaming devices
- Internet radio players
- Generic Low-power IoT Sensor Hubs
- Generic Low-power IoT Data Loggers
- Cameras for Video Streaming
- USB Devices
- Speech Recognition
- Image Recognition
- Wi-Fi + Bluetooth Networking Card
- Touch Sensing
  - Waterproof design
  - Distance sensing applications
  - Linear slider, wheel slider designs

**Note:**

ESP32-S3 Touch Sensor has not passed the Conducted Susceptibility (CS) test for now, and thus has limited application scenarios.

# Contents

<b>Product Overview</b>	2
Solution Highlights	2
Features	3
Applications	4
<b>1 ESP32-S3 Series Comparison</b>	11
1.1 ESP32-S3 Series Nomenclature	11
1.2 Comparison	11
<b>2 Pin Definition</b>	12
2.1 Pin Layout	12
2.2 Pin Description	13
2.3 Pin Name Description	16
2.4 Function Name Description	16
2.5 GPIO Functions	17
2.6 Pin-to-Pin Mapping Between Chip and SiP Flash/PSRAM	19
2.7 Power Scheme	20
2.8 Strapping Pins	21
<b>3 Functional Description</b>	25
3.1 CPU and Memory	25
3.1.1 CPU	25
3.1.2 Internal Memory	25
3.1.3 External Flash and RAM	25
3.1.4 Address Mapping Structure	26
3.1.5 Cache	26
3.1.6 eFuse Controller	27
3.1.7 Processor Instruction Extensions	27
3.2 RTC and Low-Power Management	27
3.2.1 Power Management Unit (PMU)	27
3.2.2 Ultra-Low-Power Coprocessor	28
3.3 Analog Peripherals	28
3.3.1 Analog-to-Digital Converter (ADC)	28
3.3.2 Temperature Sensor	28
3.3.3 Touch Sensor	29
3.4 System Components	29
3.4.1 Reset and Clock	29
3.4.2 Interrupt Matrix	29
3.4.3 Permission Control	30
3.4.4 System Registers	30
3.4.5 GDMA Controller	31
3.4.6 CPU Clock	31
3.4.7 RTC Clock	31

3.4.8	Clock Glitch Detection	31
3.5	Digital Peripherals	32
3.5.1	IO MUX and GPIO Matrix	32
3.5.2	Serial Peripheral Interface (SPI)	32
3.5.3	LCD Interface	33
3.5.4	Camera Interface	34
3.5.5	UART Controller	34
3.5.6	I2C Interface	34
3.5.7	I2S Interface	35
3.5.8	Remote Control Peripheral	35
3.5.9	Pulse Count Controller	35
3.5.10	LED PWM Controller	36
3.5.11	USB 2.0 OTG Full-Speed Interface	36
3.5.12	USB Serial/JTAG Controller	37
3.5.13	Motor Control PWM (MCPWM)	37
3.5.14	SD/MMC Host Controller	37
3.5.15	TWAI® Controller	38
3.6	Radio and Wi-Fi	38
3.6.1	2.4 GHz Receiver	39
3.6.2	2.4 GHz Transmitter	39
3.6.3	Clock Generator	39
3.6.4	Wi-Fi Radio and Baseband	39
3.6.5	Wi-Fi MAC	40
3.6.6	Networking Features	40
3.7	Bluetooth LE	40
3.7.1	Bluetooth LE Radio and PHY	40
3.7.2	Bluetooth LE Link Layer Controller	40
3.8	Timers and Watchdogs	41
3.8.1	General Purpose Timers	41
3.8.2	System Timer	41
3.8.3	Watchdog Timers	42
3.8.4	XTAL32K Watchdog Timers	42
3.9	Cryptography/Security Components	42
3.9.1	External Memory Encryption and Decryption	42
3.9.2	Secure Boot	43
3.9.3	HMAC Accelerator	43
3.9.4	Digital Signature	43
3.9.5	World Controller	43
3.9.6	SHA Accelerator	44
3.9.7	AES Accelerator	44
3.9.8	RSA Accelerator	45
3.9.9	Random Number Generator	45
3.10	Peripheral Pin Configurations	45
<b>4</b>	<b>Electrical Characteristics</b>	<b>51</b>
4.1	Absolute Maximum Ratings	51

4.2	Recommended Operating Conditions	51
4.3	VDD_SPI Output Characteristics	51
4.4	DC Characteristics (3.3 V, 25 °C)	52
4.5	ADC Characteristics	52
4.6	Current Consumption	53
4.7	Reliability	54
4.8	Wi-Fi Radio	55
4.8.1	Wi-Fi RF Transmitter (TX) Specifications	55
4.8.2	Wi-Fi RF Receiver (RX) Specifications	56
4.9	Bluetooth LE Radio	57
4.9.1	Bluetooth LE RF Transmitter (TX) Specifications	57
4.9.2	Bluetooth LE RF Receiver (RX) Specifications	59
<b>5</b>	<b>Package Information</b>	<b>62</b>
<b>6</b>	<b>Related Documentation and Resources</b>	<b>63</b>
	<b>Revision History</b>	<b>64</b>



## List of Tables

1	ESP32-S3 Series Comparison	11
2	Pin Description	13
3	Pin Name Description	16
4	Function Name Description	16
5	GPIO Functions	17
6	Pin-to-Pin Mapping Between Chip and SiP Flash/PSRAM	19
7	Description of ESP32-S3 Power-up and Reset Timing Parameters	21
8	JTAG Signal Source Selection	22
9	Strapping Pins	22
10	The Default Value for VDD_SPI Voltage	23
11	Parameter Descriptions of Setup and Hold Times for the Strapping Pin	24
12	Connection Between ESP32-S3 and External Flash	33
13	Peripheral Pin Configurations	45
14	Absolute Maximum Ratings	51
15	Recommended Operating Conditions	51
16	VDD_SPI Output Characteristics	51
17	DC Characteristics (3.3 V, 25 °C)	52
18	ADC Characteristics	52
19	ADC Calibration Results	53
20	Wi-Fi Current Consumption Depending on RF Modes	53
21	Current Consumption Depending on Work Modes (except Modem-sleep)	53
22	Current Consumption in Modem-sleep Mode	54
23	Reliability Qualifications	54
24	Wi-Fi Frequency	55
25	TX Power with Spectral Mask and EVM Meeting 802.11 Standards	55
26	TX EVM Test	56
27	RX Sensitivity	56
28	Maximum RX Level	57
29	RX Adjacent Channel Rejection	57
30	Bluetooth LE Frequency	57
31	Transmitter Characteristics - Bluetooth LE 1 Mbps	58
32	Transmitter Characteristics - Bluetooth LE 2 Mbps	58
33	Transmitter Characteristics - Bluetooth LE 125 Kbps	58
34	Transmitter Characteristics - Bluetooth LE 500 Kbps	59
35	Receiver Characteristics - Bluetooth LE 1 Mbps	59
36	Receiver Characteristics - Bluetooth LE 2 Mbps	60
37	Receiver Characteristics - Bluetooth LE 125 Kbps	60
38	Receiver Characteristics - Bluetooth LE 500 Kbps	61

## List of Figures

1	Block Diagram of ESP32-S3	2
2	ESP32-S3 Series Nomenclature	11
3	ESP32-S3 Pin Layout (Top View)	12
4	ESP32-S3 Power Scheme	21
5	ESP32-S3 Power-up and Reset Timing	21
6	Setup and Hold Times for the Strapping Pin	24
7	Address Mapping Structure	26
8	QFN56 (7×7 mm) Package	62

# 1. ESP32-S3 Series Comparison

## 1.1 ESP32-S3 Series Nomenclature

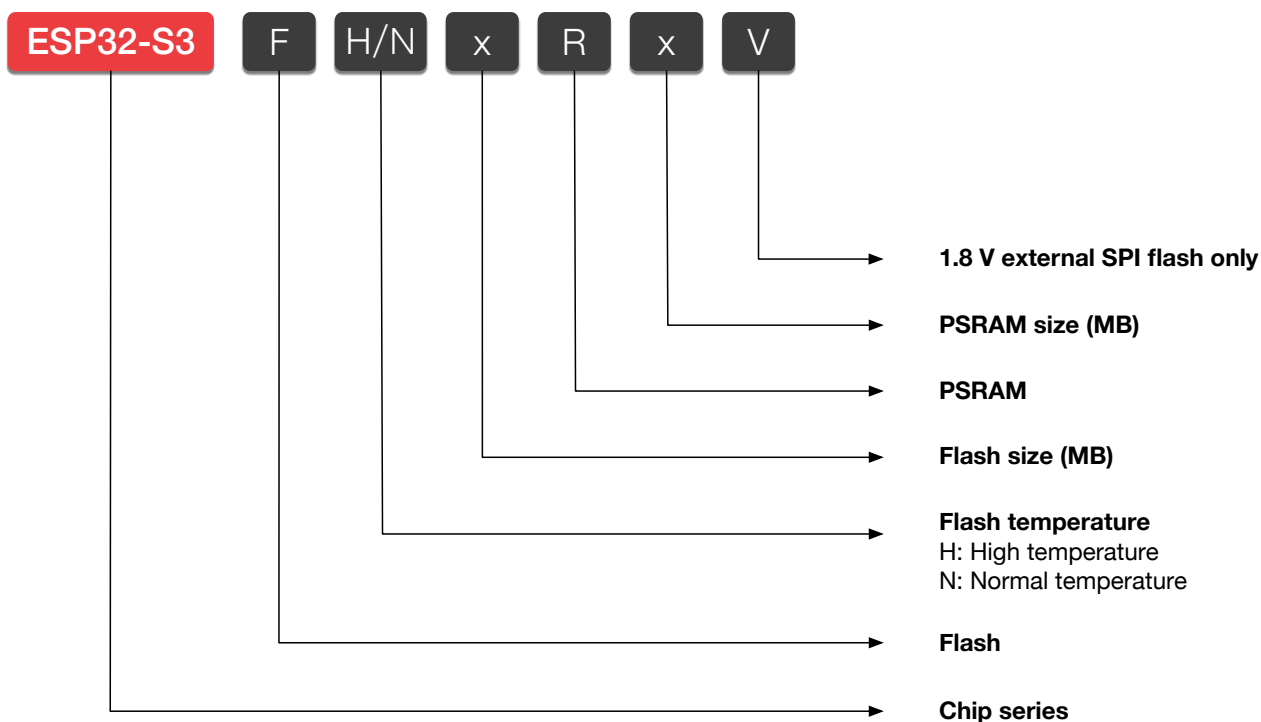

Figure 2: ESP32-S3 Series Nomenclature

## 1.2 Comparison

Table 1: ESP32-S3 Series Comparison

Ordering Code	SiP Flash	SiP PSRAM	Ambient Temperature (°C)	SPI Voltage
ESP32-S3	—	—	-40 ~ 105	3.3 V/1.8 V
ESP32-S3FN8	8 MB (Quad SPI)	—	-40 ~ 85	3.3 V
ESP32-S3R2	—	2 MB (Quad SPI)	-40 ~ 85	3.3 V
ESP32-S3R8	—	8 MB (Octal SPI)	-40 ~ 65	3.3 V
ESP32-S3R8V	—	8 MB (Octal SPI)	-40 ~ 65	1.8 V
ESP32-S3FH4R2	4 MB (Quad SPI)	2 MB (Quad SPI)	-40 ~ 105	3.3 V

<sup>1</sup> SiP refers to flash/PSRAM integrated into the package.

<sup>2</sup> Octal SPI occupies five more GPIOs (GPIO33 ~ GPIO37) than Quad SPI.

<sup>3</sup> The ESP32-S3FH4R2 chip is still in **sample status**.

## 2. Pin Definition

### 2.1 Pin Layout

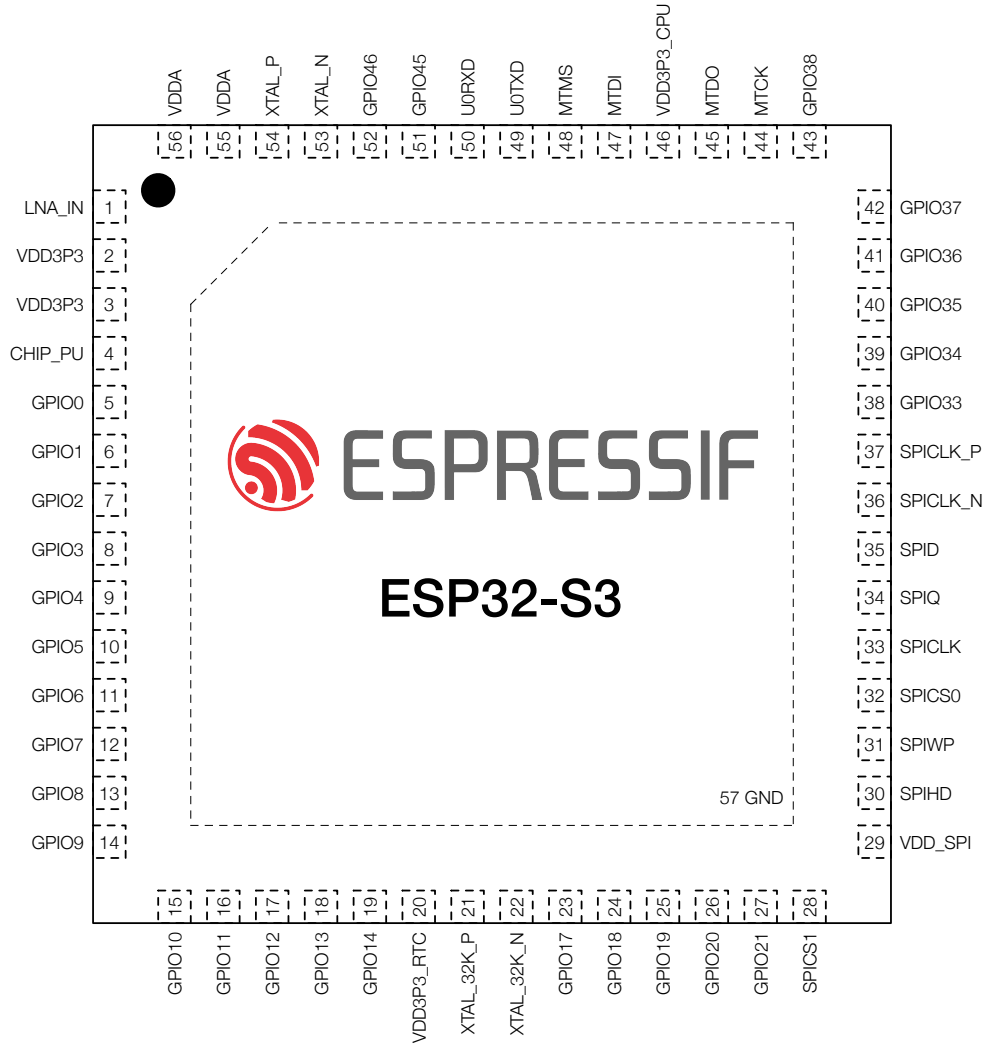

Figure 3: ESP32-S3 Pin Layout (Top View)

## 2.2 Pin Description

Table 2: Pin Description

Name	No.	Type	Power Domain	Function
LNA_IN	1	I/O	—	Low Noise Amplifier (RF LNA) input and output signal
VDD3P3	2	P <sub>A</sub>	—	Analog power supply
VDD3P3	3	P <sub>A</sub>	—	Analog power supply
CHIP_PU	4	I	VDD3P3_RTC	High: on, enables the chip. Low: off, the chip powers off. Note: Do not leave the CHIP_PU pin floating.
GPIO0	5	I/O/T	VDD3P3_RTC	RTC_GPIO0, <b>GPIO0</b>
GPIO1	6	I/O/T	VDD3P3_RTC	RTC_GPIO1, <b>GPIO1</b> , TOUCH1, ADC1_CH0
GPIO2	7	I/O/T	VDD3P3_RTC	RTC_GPIO2, <b>GPIO2</b> , TOUCH2, ADC1_CH1
GPIO3	8	I/O/T	VDD3P3_RTC	RTC_GPIO3, <b>GPIO3</b> , TOUCH3, ADC1_CH2
GPIO4	9	I/O/T	VDD3P3_RTC	RTC_GPIO4, <b>GPIO4</b> , TOUCH4, ADC1_CH3
GPIO5	10	I/O/T	VDD3P3_RTC	RTC_GPIO5, <b>GPIO5</b> , TOUCH5, ADC1_CH4
GPIO6	11	I/O/T	VDD3P3_RTC	RTC_GPIO6, <b>GPIO6</b> , TOUCH6, ADC1_CH5
GPIO7	12	I/O/T	VDD3P3_RTC	RTC_GPIO7, <b>GPIO7</b> , TOUCH7, ADC1_CH6
GPIO8	13	I/O/T	VDD3P3_RTC	RTC_GPIO8, <b>GPIO8</b> , TOUCH8, ADC1_CH7, SUBSPICS1
GPIO9	14	I/O/T	VDD3P3_RTC	RTC_GPIO9, <b>GPIO9</b> , TOUCH9, ADC1_CH8, SUBSPIHD, FSPIHD
GPIO10	15	I/O/T	VDD3P3_RTC	RTC_GPIO10, <b>GPIO10</b> , TOUCH10, ADC1_CH9, FSPIIO4, SUBSPICS0, FSPICS0
GPIO11	16	I/O/T	VDD3P3_RTC	RTC_GPIO11, <b>GPIO11</b> , TOUCH11, ADC2_CH0, FSPIIO5, SUBSPID, FSPID
GPIO12	17	I/O/T	VDD3P3_RTC	RTC_GPIO12, <b>GPIO12</b> , TOUCH12, ADC2_CH1, FSPIIO6, SUBSPICLK, FSPICLK
GPIO13	18	I/O/T	VDD3P3_RTC	RTC_GPIO13, <b>GPIO13</b> , TOUCH13, ADC2_CH2, FSPIIO7, SUBSPIQ, FSPIQ
GPIO14	19	I/O/T	VDD3P3_RTC	RTC_GPIO14, <b>GPIO14</b> , TOUCH14, ADC2_CH3, FSPIDQS, SUBSPIWP, FSPWP
VDD3P3_RTC	20	P <sub>A</sub>	—	Analog power supply
XTAL_32K_P	21	I/O/T	VDD3P3_RTC	RTC_GPIO15, <b>GPIO15</b> , U0RTS, ADC2_CH4, XTAL_32K_P
XTAL_32K_N	22	I/O/T	VDD3P3_RTC	RTC_GPIO16, <b>GPIO16</b> , U0CTS, ADC2_CH5, XTAL_32K_N
GPIO17	23	I/O/T	VDD3P3_RTC	RTC_GPIO17, <b>GPIO17</b> , U1TXD, ADC2_CH6
GPIO18	24	I/O/T	VDD3P3_RTC	RTC_GPIO18, <b>GPIO18</b> , U1RXD, ADC2_CH7, CLK_OUT3

Name	No.	Type	Power Domain	Function
GPIO19	25	I/O/T	VDD3P3_RTC	RTC_GPIO19, GPIO19, U1RTS, ADC2_CH8, CLK_OUT2, <b>USB_D-</b>
GPIO20	26	I/O/T	VDD3P3_RTC	RTC_GPIO20, GPIO20, U1CTS, ADC2_CH9, CLK_OUT1, <b>USB_D+</b>
GPIO21	27	I/O/T	VDD3P3_RTC	RTC_GPIO21, <b>GPIO21</b>
SPICS1	28	I/O/T	VDD_SPI	SPICS1, <b>GPIO26</b>
VDD_SPI	29	P <sub>D</sub>	—	Output power supply: 1.8 V or VDD3P3_RTC
SPIHD	30	I/O/T	VDD_SPI	<b>SPIHD</b> , GPIO27
SPIWP	31	I/O/T	VDD_SPI	<b>SPIWP</b> , GPIO28
SPICS0	32	I/O/T	VDD_SPI	<b>SPICS0</b> , GPIO29
SPICLK	33	I/O/T	VDD_SPI	<b>SPICLK</b> , GPIO30
SPIQ	34	I/O/T	VDD_SPI	<b>SPIQ</b> , GPIO31
SPID	35	I/O/T	VDD_SPI	<b>SPID</b> , GPIO32
SPICLK_N	36	I/O/T	VDD_SPI	SPICLK_N_DIFF, <b>GPIO48</b> , SUBSPICLK_N_DIFF
SPICLK_P	37	I/O/T	VDD_SPI	SPICLK_P_DIFF, <b>GPIO47</b> , SUBSPICLK_P_DIFF
GPIO33	38	I/O/T	VDD3P3_CPU / VDD_SPI	SPIIO4, <b>GPIO33</b> , FSPIHD, SUBSPIHD
GPIO34	39	I/O/T	VDD3P3_CPU / VDD_SPI	SPIIO5, <b>GPIO34</b> , FSPICS0, SUBSPICS0
GPIO35	40	I/O/T	VDD3P3_CPU / VDD_SPI	SPIIO6, <b>GPIO35</b> , FSPID, SUBSPID
GPIO36	41	I/O/T	VDD3P3_CPU / VDD_SPI	SPIIO7, <b>GPIO36</b> , FSPICLK, SUBSPICLK
GPIO37	42	I/O/T	VDD3P3_CPU / VDD_SPI	SPIDQS, <b>GPIO37</b> , FSPIQ, SUBSPIQ
GPIO38	43	I/O/T	VDD3P3_CPU	<b>GPIO38</b> , FSPIWP, SUBSPIWP
MTCK	44	I/O/T	VDD3P3_CPU	<b>MTCK</b> , GPIO39, CLK_OUT3, SUBSPICS1
MTDO	45	I/O/T	VDD3P3_CPU	<b>MTDO</b> , GPIO40, CLK_OUT2
VDD3P3_CPU	46	P <sub>D</sub>	—	Input power supply for CPU IO
MTDI	47	I/O/T	VDD3P3_CPU	<b>MTDI</b> , GPIO41, CLK_OUT1
MTMS	48	I/O/T	VDD3P3_CPU	<b>MTMS</b> , GPIO42
U0TXD	49	I/O/T	VDD3P3_CPU	<b>U0TXD</b> , GPIO43, CLK_OUT1
U0RXD	50	I/O/T	VDD3P3_CPU	<b>U0RXD</b> , GPIO44, CLK_OUT2
GPIO45	51	I/O/T	VDD3P3_CPU	<b>GPIO45</b>
GPIO46	52	I/O/T	VDD3P3_CPU	<b>GPIO46</b>
XTAL_N	53	—	—	External crystal output

Name	No.	Type	Power Domain	Function
XTAL_P	54	—	—	External crystal input
VDDA1	55	P <sub>A</sub>	—	Analog power supply
VDDA2	56	P <sub>A</sub>	—	Analog power supply
GND	57	G	—	Ground

<sup>1</sup> P: power pin; P<sub>A</sub>: analog power pin; P<sub>D</sub>: digital power pin; I: input; O: output; T: high impedance.

<sup>2</sup> Pin functions in bold font are the default pin functions in SPI Boot mode. For pins No.38 ~ 42, the default function is decided by eFuse bit.

<sup>3</sup> Power supply for GPIO33, GPIO34, GPIO35, GPIO36 and GPIO37 is configurable to be either VDD3P3\_CPU (default) or VDD\_SPI.

<sup>4</sup> The pin function in this table refers only to some fixed settings and do not cover all cases for signals that can be input and output through the GPIO matrix. For more information on the GPIO matrix, please refer to [ESP32-S3 Technical Reference Manual](#).

## 2.3 Pin Name Description

The explanation of each pin name is briefly described below.

**Table 3: Pin Name Description**

Pin Name	Description
GPIOx	General-purpose input and output (x is GPIO number). GPIO pins can be assigned various functions, including digital and analog functions. For more information on digital functions, please refer to Table 5.
SPIx	SiP flash/PSRAM and external flash/RAM interface (x is CLK, CS0, CS1, D, Q, WP, HD, IO4~7 or DQS).
XTAL_32K_P/N	32 KHz external clock input/output (connecting to ESP32-S3's oscillator). P/N means differential clock positive/negative.
XTAL_P/N	External clock input/output (connecting to ESP32-S3's oscillator). P/N means differential clock positive/negative.
U0RXD/U0TXD	UART0 receive/transmit signals.
MTCK/MTDO/MTDI/MTMS	JTAG interface signals.
LNA_IN	Low-Noise Amplifier (RF LNA) input/output signals.
CHIP_PU	Chip power up pin.
GND	External ground connection.
VDDA	Power supply for analog domain.
VDD3P3_RTC	Power supply for RTC digital domain.
VDD3P3_CPU	Power supply for digital domain.
VDD_SPI	Power supply for SPI IOs.

## 2.4 Function Name Description

The explanation of each function name is briefly described below.

**Table 4: Function Name Description**

Function Name	Description
RTC_GPIOx	RTC domain GPIO function for low power management.
TOUCHx	Analog function for touch sensing.
ADCx_CHy	Analog to digital conversion channel (x is ADC number, y is channel number).
SUBSPIx	Sub-SPI0/1 bus, differing from SPIx bus (x is CLK, CS0, CS1, D, Q, WP or HD), used for different voltage level of flash and PSRAM
FSPIx	8-line Fast-SPI2 bus function (x is CLK, CS0, CS1, D, Q, WP, HD, IO4~7 or DQS)
SPIx	SPI0/1 bus function (x is CLK, CS0, CS1, D, Q, WP, HD, IO4~7 or DQS)
UxRTS/UxCTS	UARTx hardware flow control signals (x is UART number).
U1RXD/U1TXD	UART1 receive/transmit signals.
CLK_OUTx	Clock output for debug (x is clock number).
USB_D-/USB_D+	USB OTG and USB Serial/JTAG function. USB signal is a differential signal transmitted over a pair of D+ and D- wires.
SPICLK_N/P_DIFF	Serial peripheral interface differential clock negative/positive.



## 2.5 GPIO Functions

ESP32-S3 has 45 GPIO pins (numbering 22-25 is not used) which can be assigned various functions as listed in Table 5. The functions listed here are digital functions (F0-F4). RTC functions and analog functions can be found in Table 2.

Table 5: GPIO Functions

GPIO	Pin Name	F0	Type	F1	Type	F2	Type	F3	Type	F4	Type	At Reset	After Reset	Notes
0	GPIO0	GPIO0	I/O/T	GPIO0	I/O/T	-	-	-	-	-	-	IE1, WPU1	IE1, WPU1	R
1	GPIO1	GPIO1	I/O/T	GPIO1	I/O/T	-	-	-	-	-	-	IE1	IE1	R
2	GPIO2	GPIO2	I/O/T	GPIO2	I/O/T	-	-	-	-	-	-	IE1	IE1	R
3	GPIO3	GPIO3	I/O/T	GPIO3	I/O/T	-	-	-	-	-	-	IE1	IE1	R
4	GPIO4	GPIO4	I/O/T	GPIO4	I/O/T	-	-	-	-	-	-	IE0	IE0	R
5	GPIO5	GPIO5	I/O/T	GPIO5	I/O/T	-	-	-	-	-	-	IE0	IE0	R
6	GPIO6	GPIO6	I/O/T	GPIO6	I/O/T	-	-	-	-	-	-	IE0	IE0	R
7	GPIO7	GPIO7	I/O/T	GPIO7	I/O/T	-	-	-	-	-	-	IE0	IE0	R
8	GPIO8	GPIO8	I/O/T	GPIO8	I/O/T	-	-	SUBSPICS1	O/T	-	-	IE0	IE0	R
9	GPIO9	GPIO9	I/O/T	GPIO9	I/O/T	-	-	SUBSPIHD	I1/O/T	FSPiHD	I1/O/T	IE0	IE1	R
10	GPIO10	GPIO10	I/O/T	GPIO10	I/O/T	FSPIIO4	I1/O/T	SUBSPICS0	O/T	FSPICS0	I1/O/T	IE0	IE1	R
11	GPIO11	GPIO11	I/O/T	GPIO11	I/O/T	FSPIIO5	I1/O/T	SUBSPID	I1/O/T	FSPID	I1/O/T	IE0	IE1	R
12	GPIO12	GPIO12	I/O/T	GPIO12	I/O/T	FSPIIO6	I1/O/T	SUBSPICLK	O/T	FSPICLK	I1/O/T	IE0	IE1	R
13	GPIO13	GPIO13	I/O/T	GPIO13	I/O/T	FSPIIO7	I1/O/T	SUBSPIQ	I1/O/T	FSPiQ	I1/O/T	IE0	IE1	R
14	GPIO14	GPIO14	I/O/T	GPIO14	I/O/T	FSPIDQS	O/T	SUBSPIWP	I1/O/T	FSPiWP	I1/O/T	IE0	IE1	R
15	XTAL_32K_P	GPIO15	I/O/T	GPIO15	I/O/T	U0RTS	O	-	-	-	-	IE0	IE0	R
16	XTAL_32K_N	GPIO16	I/O/T	GPIO16	I/O/T	U0CTS	I1	-	-	-	-	IE0	IE0	R
17	GPIO17	GPIO17	I/O/T	GPIO17	I/O/T	U1TXD	O	-	-	-	-	IE0	IE1	R
18	GPIO18	GPIO18	I/O/T	GPIO18	I/O/T	U1RXD	I1	CLK_OUT3	O	-	-	IE0	IE1	R
19	GPIO19	GPIO19	I/O/T	GPIO19	I/O/T	U1RTS	O	CLK_OUT2	O	-	-	IE0	IE0	R
20	GPIO20	GPIO20	I/O/T	GPIO20	I/O/T	U1CTS	I1	CLK_OUT1	O	-	-	IE0	IE0	R
21	GPIO21	GPIO21	I/O/T	GPIO21	I/O/T	-	-	-	-	-	-	IE0	IE0	R
26	SPICS1	SPICS1	O/T	GPIO26	I/O/T	-	-	-	-	-	-	IE1, WPU1	IE1, WPU1	-
27	SPIHD	SPIHD	I1/O/T	GPIO27	I/O/T	-	-	-	-	-	-	IE1, WPU1	IE1, WPU1	-
28	SPIWP	SPIWP	I1/O/T	GPIO28	I/O/T	-	-	-	-	-	-	IE1, WPU1	IE1, WPU1	-
29	SPICS0	SPICS0	O/T	GPIO29	I/O/T	-	-	-	-	-	-	IE1, WPU1	IE1, WPU1	-

GPIO	Pin Name	F0	Type	F1	Type	F2	Type	F3	Type	F4	Type	At Reset	After Reset	Notes
30	SPICLK	SPICLK	O/T	GPIO30	I/O/T	-	-	-	-	-	-	IE1, WPU1	IE1, WPU1	-
31	SPIQ	SPIQ	I1/O/T	GPIO31	I/O/T	-	-	-	-	-	-	IE1, WPU1	IE1, WPU1	-
32	SPID	SPID	I1/O/T	GPIO32	I/O/T	-	-	-	-	-	-	IE1, WPU1	IE1, WPU1	-
33	GPIO33	GPIO33	I/O/T	GPIO33	I/O/T	FSPIHD	I1/O/T	SUBSPIHD	I1/O/T	SPIIO4	I1/O/T	IE0	IE1	-
34	GPIO34	GPIO34	I/O/T	GPIO34	I/O/T	FSPICS0	I1/O/T	SUBSPICS0	O/T	SPIIO5	I1/O/T	IE0	IE1	-
35	GPIO35	GPIO35	I/O/T	GPIO35	I/O/T	FSPID	I1/O/T	SUBSPID	I1/O/T	SPIIO6	I1/O/T	IE0	IE1	-
36	GPIO36	GPIO36	I/O/T	GPIO36	I/O/T	FSPICLK	I1/O/T	SUBSPICLK	O/T	SPIIO7	I1/O/T	IE0	IE1	-
37	GPIO37	GPIO37	I/O/T	GPIO37	I/O/T	FSPIQ	I1/O/T	SUBSPIQ	I1/O/T	SPIDQS	I0/O/T	IE0	IE1	-
38	GPIO38	GPIO38	I/O/T	GPIO38	I/O/T	FSPWIP	I1/O/T	SUBSPWIP	I1/O/T	-	-	IE0	IE1	-
39	MTCK	MTCK	I1	GPIO39	I/O/T	CLK_OUT3	O	SUBSPICS1	O/T	-	-	IE0	IE1, or IE1&WPU1	-
40	MTDO	MTDO	O/T	GPIO40	I/O/T	CLK_OUT2	O	-	-	-	-	IE0	IE1	-
41	MTDI	MTDI	I1	GPIO41	I/O/T	CLK_OUT1	O	-	-	-	-	IE0	IE1	-
42	MTMS	MTMS	I1	GPIO42	I/O/T	-	-	-	-	-	-	IE0	IE1	-
43	U0TXD	U0TXD	O	GPIO43	I/O/T	CLK_OUT1	O	-	-	-	-	IE1, WPU1	IE1, WPU1	-
44	U0RXD	U0RXD	I1	GPIO44	I/O/T	CLK_OUT2	O	-	-	-	-	IE1, WPU1	IE1, WPU1	-
45	GPIO45	GPIO45	I/O/T	GPIO45	I/O/T	-	-	-	-	-	-	IE1, WPD1	IE1, WPD1	-
46	GPIO46	GPIO46	I/O/T	GPIO46	I/O/T	-	-	-	-	-	-	IE1, WPD1	IE1, WPD1	-
47	SPICLK_P	SPICLK_P_DIFF	O/T	GPIO47	I/O/T	SUBSPI- CLK_P_DIFF	O/T	-	-	-	-	IE1	IE1	-
48	SPICLK_N	SPICLK_N_DIFF	O/T	GPIO48	I/O/T	SUBSPI- CLK_N_DIFF	O/T	-	-	-	-	IE1	IE1	-

Please refer to the next page for more information on GPIO functions.

## Type

Each digital function ( $F_n$ ,  $n=0\sim4$ ) is associated with a “Type”. The description of “Type” is as follows:

- O: Output only.
- O/T: The signal can be output or high-impedance.
- I/O/T: The signal can be input, output, and high-impedance.
- I1: Input only. If the pin is assigned a function other than  $F_n$ , the input signal of  $F_n$  is always “1”.
- I1/O/T: The signal can be input, output, and high-impedance. If  $F_n$  is not selected, the input signal of  $F_n$  is always “1”.
- I0/O/T: The signal can be input, output, and high-impedance. If  $F_n$  is not selected, the input signal of  $F_n$  is always “0”.

## At Reset/After Reset

The default configuration of each pin at reset and after reset:

- **IE0** - input disabled
- **IE1** - input enabled
- **IE1, WPD1** - input enabled, internal weak pull-down resistor enabled
- **IE1, WPU1** - input enabled, internal weak pull-up resistor enabled
- **IE1, or IE1&WPU1** - When the value of eFuse bit EFUSE\_DIS\_PAD\_JTAG is
  - 1, the MTCK pin floats after chip reset (IE1)
  - 0, the MTCK pin connects to internal weak pull-up resistor after chip reset (IE1&WPU1)

## Notes

- **R** - These pins have RTC or analog functions.

## Drive Strength

- The default drive strength of GPIO19 ~ 20 is 2'd3 (~40 mA).
- The default drive strength of other pins is 2'd2 (~20 mA).

## 2.6 Pin-to-Pin Mapping Between Chip and SiP Flash/PSRAM

Table 6 lists the pin-to-pin mapping between the chip and the SiP flash/PSRAM. The chip pins listed here are not recommended for other usage. For the data port connection between ESP32-S3 and external flash please refer to Section 3.5.2.

**Table 6: Pin-to-Pin Mapping Between Chip and SiP Flash/PSRAM**

ESP32-S3FN8 (8 MB) / ESP32-S3FH4R2 (4 MB)	SiP Flash (Quad SPI)
SPICLK	CLK
SPICS0	CS#
SPID	DI
SPIQ	DO
SPIWP	WP#
SPIHD	HOLD#

ESP32-S3R2 / ESP32-S3FH4R2	SiP PSRAM (2 MB, Quad SPI)
SPICLK	CLK
SPICS1	CE#
SPID	SI/SIO0
SPIQ	SO/SIO1
SPIWP	SIO2
SPIHD	SIO3
ESP32-S3R8 / ESP32-S3R8V	SiP PSRAM (8 MB, Octal SPI)
SPICLK	CLK
SPICS1	CE#
SPID	DQ0
SPIQ	DQ1
SPIWP	DQ2
SPIHD	DQ3
GPIO33	DQ4
GPIO34	DQ5
GPIO35	DQ6
GPIO36	DQ7
GPIO37	DQS/DM

## 2.7 Power Scheme

ESP32-S3 has four input power pins:

- VDDA1
- VDDA2
- VDD3P3\_RTC
- VDD3P3\_CPU

And one input/output power pin:

- VDD\_SPI

VDDA1 and VDDA2 are the input power supply for the analog domain.

VDD\_SPI can be an input power supply or output power supply. It can be powered by Flash Voltage Regulator (nominal 1.8 V) or by VDD3P3\_RTC via  $R_{SPI}$  (nominal 3.3 V). As the SiP flash/PSRAM in ESP32-S3FN8, ESP32-S3R2, and ESP32-S3R8 operates at 3.3 V, VDD\_SPI must be powered by VDD3P3\_RTC via  $R_{SPI}$ . Software can power off VDD\_SPI to minimize current leakage of flash in Deep-sleep mode.

VDD3P3\_RTC is the input power supply for Low Power Voltage Regulator that powers the RTC domain.

VDD3P3\_CPU and VDD3P3\_RTC power Digital System Voltage Regulator at the same time that further powers the Digital System domain.

VDD3P3\_RTC is the input power supply for RTC IO.

VDD3P3\_CPU is the input power supply for Digital IO.

VDD\_SPI is the input power supply for SPI IO.

Either VDD\_SPI or VDD3P3\_CPU can be selected as the input power supply for SPI/Digital IO.

The power scheme diagram is shown in Figure 4.

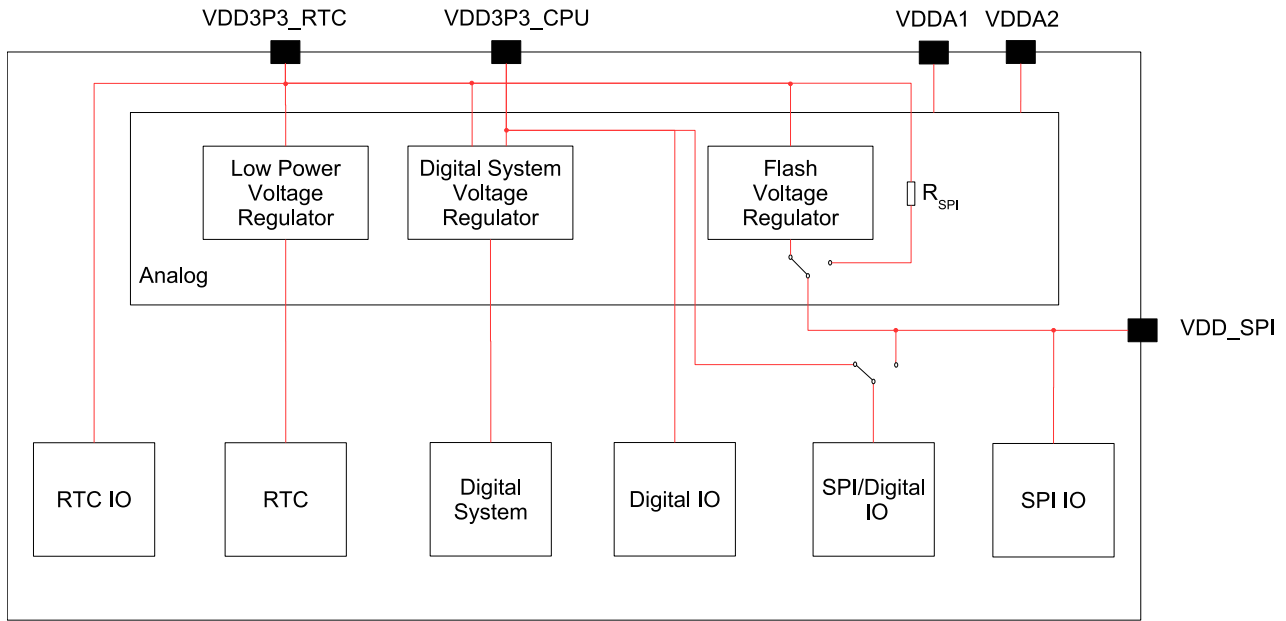

Figure 4: ESP32-S3 Power Scheme

**Notes on CHIP\_PU:**

Figure 5 shows the power-up and reset timing of ESP32-S3 series. Details about the parameters are listed in Table 7.

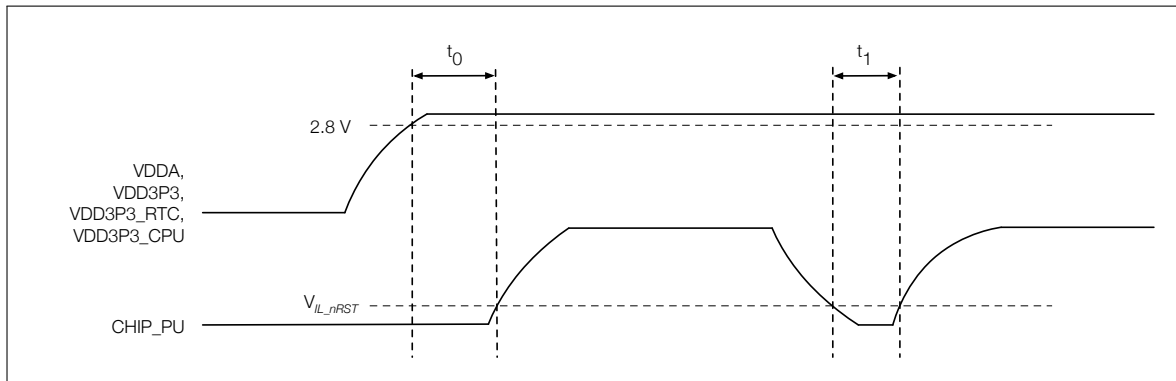

Figure 5: ESP32-S3 Power-up and Reset Timing

Table 7: Description of ESP32-S3 Power-up and Reset Timing Parameters

Parameter	Description	Min ( $\mu$ s)
$t_0$	Time between bringing up the VDDA, VDD3P3, VDD3P3_RTC, and VDD3P3_CPU rails, and activating CHIP_PU	50
$t_1$	Duration of CHIP_PU signal level < $V_{IL\_nRST}$ (refer to its value in Table 17) to reset the chip	50

## 2.8 Strapping Pins

ESP32-S3 has four strapping pins:

- GPIO0
- GPIO45
- GPIO46
- GPIO3

Software can read the values of corresponding bits from register “GPIO\_STRAPPING”.

During the chip’s system reset (power-on-reset, RTC watchdog reset, brownout reset, analog super watchdog reset, and crystal clock glitch detection reset), the latches of the strapping pins sample the voltage level as strapping bits of “0” or “1”, and hold these bits until the chip is powered down or shut down.

GPIO0, GPIO45 and GPIO46 are connected to the chip’s internal weak pull-up/pull-down during the chip reset. Consequently, if they are unconnected or the connected external circuit is high-impedance, the internal weak pull-up/pull-down will determine the default input level of these strapping pins.

GPIO3 is floating by default. Its strapping value can be configured to determine the source of the JTAG signal inside the CPU, as shown in Table 9. In this case, the strapping value is controlled by the external circuit that cannot be in a high impedance state. Table 8 shows more configuration combinations of EFUSE\_DIS\_USB\_JTAG, EFUSE\_DIS\_PAD\_JTAG, and EFUSE\_STRAP\_JTAG\_SEL that determine the JTAG signal source.

**Table 8: JTAG Signal Source Selection**

EFUSE_STRAP_JTAG_SEL	EFUSE_DIS_USB_JTAG	EFUSE_DIS_PAD_JTAG	JTAG Signal Source
1	0	0	Refer to Table 9
0	0	0	USB Serial/JTAG controller
don’t care	0	1	USB Serial/JTAG controller
don’t care	1	0	On-chip JTAG pins
don’t care	1	1	N/A

To change the strapping bit values, users can apply the external pull-down/pull-up resistances, or use the host MCU’s GPIOs to control the voltage level of these pins when powering on ESP32-S3.

After reset, the strapping pins work as normal-function pins.

Refer to Table 9 for a detailed configuration of the strapping pins.

**Table 9: Strapping Pins**

VDD_SPI Voltage			
Pin	Default	3.3 V	1.8 V
GPIO45	Pull-down	0	1
Bootling Mode <sup>1</sup>			
Pin	Default	SPI Boot	Download Boot
GPIO0	Pull-up	1	0
GPIO46	Pull-down	Don’t care	0
Enabling/Disabling ROM Messages Print During Bootling <sup>2 3</sup>			
Pin	Default	Enabled	Disabled
GPIO46	Pull-down	See the fourth note	See the fourth note
JTAG Signal Selection			

Pin	Default	EFUSE_DIS_USB_JTAG = 0, EFUSE_DIS_PAD_JTAG = 0, EFUSE_STRAP_JTAG_SEL=1
GPIO3	N/A	0: JTAG signal from on-chip JTAG pins 1: JTAG signal from USB Serial/JTAG controller

**Note:**

1. The strapping combination of GPIO46 = 1 and GPIO0 = 0 is invalid and will trigger unexpected behavior.
2. ROM boot messages can be printed over U0TXD (by default) or GPIO17 (U1TXD), depending on the eFuse bit EFUSE\_UART\_PRINT\_CHANNEL.
3. When both EFUSE\_DIS\_USB\_SERIAL\_JTAG and EFUSE\_DIS\_USB\_OTG are 0, ROM boot messages will be printed to the USB Serial/JTAG controller. Otherwise, the messages will be printed to UART, controlled by GPIO46 and EFUSE\_UART\_PRINT\_CONTROL. Specifically, when EFUSE\_UART\_PRINT\_CONTROL value is:
  - 0, print is normal during boot and not controlled by GPIO46.
  - 1 and GPIO46 is 0, print is normal during boot; but if GPIO46 is 1, print is disabled.
  - 2 and GPIO46 is 0, print is disabled; but if GPIO46 is 1, print is normal.
  - 3, print is disabled and not controlled by GPIO46.

VDD\_SPI voltage is determined either by the strapping value of GPIO45 or by EFUSE\_VDD\_SPI\_TIEH. When EFUSE\_VDD\_SPI\_FORCE is 0, VDD\_SPI voltage is determined by the strapping value of GPIO45; when EFUSE\_VDD\_SPI\_FORCE is 1, VDD\_SPI voltage is determined by EFUSE\_VDD\_SPI\_TIEH. Please refer to the following table for default configurations:

**Table 10: The Default Value for VDD\_SPI Voltage**

Chip Variant	EFUSE_VDD_SPI_FORCE	EFUSE_VDD_SPI_TIEH	VDD_SPI Voltage
ESP32-S3	0	0	Determined by GPIO45
ESP32-S3R2	1	1	Force to 3.3 V
ESP32-S3R8	1	1	Force to 3.3 V
ESP32-S3R8V	1	0	Force to 1.8 V
ESP32-S3FN8	1	1	Force to 3.3 V
ESP32-S3FH4R2	1	1	Force to 3.3 V

Figure 6 shows the setup and hold times for the strapping pin before and after the CHIP\_PU signal goes high. Details about the parameters are listed in Table 11.

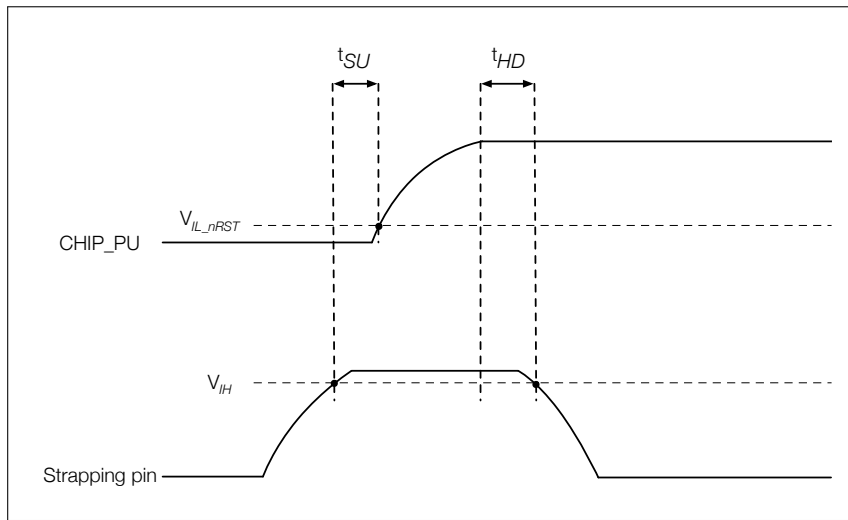

Figure 6: Setup and Hold Times for the Strapping Pin

Table 11: Parameter Descriptions of Setup and Hold Times for the Strapping Pin

Parameter	Description	Min (ms)
$t_{SU}$	Setup time before CHIP_PU goes from low to high	0
$t_{HD}$	Hold time after CHIP_PU goes high	3



## 3. Functional Description

This chapter describes the functional modules of ESP32-S3.

### 3.1 CPU and Memory

#### 3.1.1 CPU

ESP32-S3 has a low-power Xtensa® dual-core 32-bit LX7 microprocessor with the following features:

- Five-stage pipeline that supports the clock frequency of up to 240 MHz
- 16-bit/24-bit instruction set providing high code density
- 32-bit customized instruction set and 128-bit data bus that provide high computing performance
- Support for single-precision floating-point unit (FPU)
- 32-bit multiplier and 32-bit divider
- Unbuffered GPIO instructions
- 32 interrupts at six levels
- Windowed ABI with 64 physical general registers
- Trace function with TRAX compressor, up to 16 KB trace memory
- JTAG for debugging

#### 3.1.2 Internal Memory

ESP32-S3's internal memory includes:

- **384 KB ROM:** for booting and core functions
- **512 KB on-chip SRAM:** for data and instructions, running at a configurable frequency of up to 240 MHz
- **RTC FAST memory:** 8 KB SRAM that supports read/write/instruction fetch by the main CPU (LX7 dual-core processor). It can retain data in Deep-sleep mode
- **RTC SLOW Memory:** 8 KB SRAM that supports read/write/instruction fetch by the main CPU (LX7 dual-core processor) or coprocessors. It can retain data in Deep-sleep mode
- **4 Kbit eFuse:** 1792 bits are reserved for user data, such as encryption key and device ID
- **SiP flash and PSRAM:** See details in Table 1 [Comparison](#)

#### 3.1.3 External Flash and RAM

ESP32-S3 supports SPI, Dual SPI, Quad SPI, Octal SPI, QPI and OPI interfaces that allow connection to multiple external flash and RAM.

The external flash and RAM can be mapped into the CPU instruction memory space and read-only data memory space. The external RAM can also be mapped into the CPU data memory space. ESP32-S3 supports up to 1 GB of external flash and RAM, and hardware encryption/decryption based on XTS-AES to protect users' programs and data in flash and external RAM.

Through high-speed caches, ESP32-S3 can support at a time up to:

- External flash or RAM mapped into 32 MB instruction space as individual blocks of 64 KB

- External RAM mapped into 32 MB data space as individual blocks of 64 KB. 8-bit, 16-bit, 32-bit, and 128-bit reads and writes are supported. External flash can also be mapped into 32 MB data space as individual blocks of 64 KB, but only supporting 8-bit, 16-bit, 32-bit and 128-bit reads.

**Note:**

After ESP32-S3 is initialized, firmware can customize the mapping of external RAM or flash into the CPU address space.

### 3.1.4 Address Mapping Structure

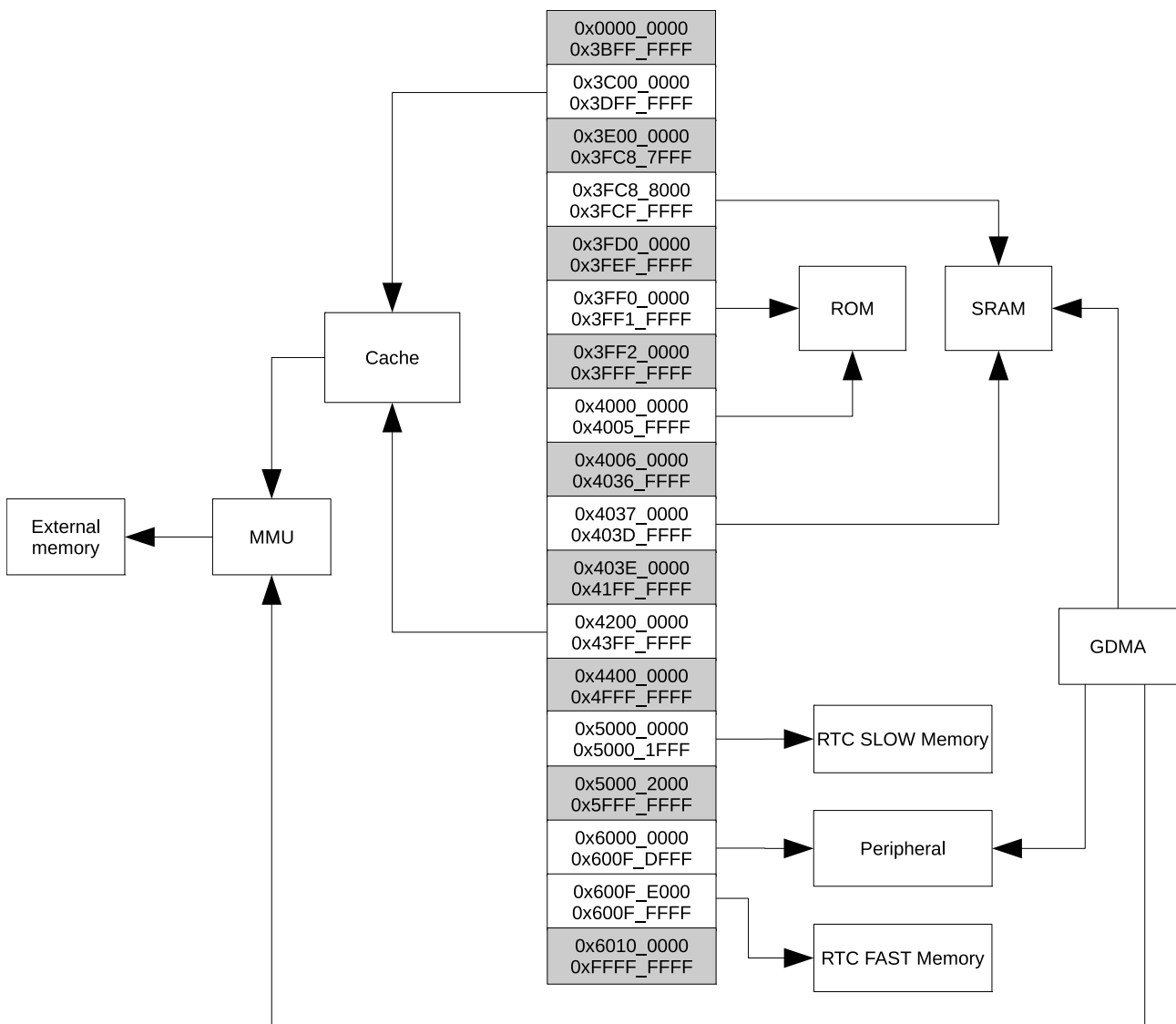

Figure 7: Address Mapping Structure

**Note:**

The memory space with gray background is not available to users.

### 3.1.5 Cache

ESP32-S3 has an instruction cache and a data cache shared by the two CPU cores. Each cache can be partitioned into multiple banks and has the following features:

- Instruction cache: 16 KB (one bank) or 32 KB (two banks)  
Data cache: 32 KB (one bank) or 64 KB (two banks)
- Instruction cache: four-way or eight-way set associative  
Data cache: four-way set associative
- Block size of 16 bytes or 32 bytes for both instruction cache and data cache
- Pre-load function
- Lock function
- Critical word first and early restart

### 3.1.6 eFuse Controller

ESP32-S3 contains a 4-Kbit eFuse to store parameters, which are burned and read by an eFuse Controller. The eFuse Controller has the following features:

- 4 Kbits in total, with 1792 bits reserved for users, e.g., encryption key and device ID
- One-time programmable storage
- Configurable write protection
- Configurable read protection
- Various hardware encoding schemes to protect against data corruption

For detailed information, please refer to Chapter [eFuse Controller](#) in *ESP32-S3 Technical Reference Manual*.

### 3.1.7 Processor Instruction Extensions

The ESP32-S3 contains a series of new extended instruction set in order to improve the operation efficiency of specific AI and DSP (Digital Signal Processing) algorithms. The Processor Instruction Extensions (PIE) has the following features:

- 128-bit new general-purpose registers
- 128-bit vector operations, e.g., complex multiplication, addition, subtraction, multiplication, shifting, comparison, etc
- Data handling instructions and load/store operation instructions combined
- Non-aligned 128-bit vector data
- Saturation operation

## 3.2 RTC and Low-Power Management

### 3.2.1 Power Management Unit (PMU)

With the use of advanced power-management technologies, ESP32-S3 can switch between different power modes.

- **Active mode:** CPU and chip radio are powered on. The chip can receive, transmit, or listen.
- **Modem-sleep mode:** The CPU is operational and the clock speed can be reduced. The wireless baseband and radio are disabled, but wireless connection can remain active.

- **Light-sleep mode:** The CPU is paused. The RTC peripherals, as well as the ULP coprocessor can be woken up periodically by the timer. Any wake-up events (MAC, host, RTC timer, or external interrupts) will wake up the chip. Wireless connection can remain active. Users can optionally decide what peripherals to shut down/keep on (refer to Figure 1), for power-saving purpose.
- **Deep-sleep mode:** CPU and most peripherals are powered down. Only the RTC memory is powered on and RTC peripherals are optional. Wi-Fi connection data are stored in the RTC memory. The ULP coprocessor is functional.

For power consumption in different power modes, please refer to Table 21.

### 3.2.2 Ultra-Low-Power Coprocessor

The ULP coprocessor is designed as a simplified, low-power replacement of CPU in sleep modes. It can be also used to supplement the functions of the CPU in normal working mode. The ULP coprocessor and RTC memory remain powered on during the Deep-sleep mode. Hence, the developer can store a program for the ULP coprocessor in the RTC slow memory to access RTC GPIO, RTC peripheral devices, RTC timers and internal sensors in Deep-sleep mode.

ESP32-S3 has two ULP coprocessors, one based on RISC-V instruction set architecture (ULP-RISC-V) and the other on finite state machine (ULP-FSM). The clock of the coprocessors is the internal fast RC oscillator.

#### ULP-RISC-V has the following features:

- Support for [RV32IMC](#) instruction set
- Thirty-two 32-bit general-purpose registers
- 32-bit multiplier and divider
- Support for interrupts
- Booted by the CPU, its dedicated timer, or RTC GPIO

#### ULP-FSM has the following features:

- Support for common instructions including arithmetic, jump, and program control instructions
- Support for on-board sensor measurement instructions
- Booted by the CPU, its dedicated timer, or RTC GPIO

Note that these two coprocessors cannot work simultaneously.

## 3.3 Analog Peripherals

### 3.3.1 Analog-to-Digital Converter (ADC)

ESP32-S3 integrates two 12-bit SAR ADCs and supports measurements on 20 channels (analog-enabled pins). For power-saving purpose, the ULP coprocessors in ESP32-S3 can also be used to measure voltage in sleep modes. By using threshold settings or other methods, we can awaken the CPU from sleep modes.

### 3.3.2 Temperature Sensor

The temperature sensor generates a voltage that varies with temperature. The voltage is internally converted via an ADC into a digital value.

The temperature sensor has a range of  $-20\text{ }^{\circ}\text{C}$  to  $110\text{ }^{\circ}\text{C}$ . It is designed primarily to sense the temperature changes inside the chip. The temperature value depends on factors such as microcontroller clock frequency or I/O load. Generally, the chip's internal temperature is higher than the ambient temperature.

### 3.3.3 Touch Sensor

ESP32-S3 has 14 capacitive-sensing GPIOs, which detect variations induced by touching or approaching the GPIOs with a finger or other objects. The low-noise nature of the design and the high sensitivity of the circuit allow relatively small pads to be used. Arrays of pads can also be used, so that a larger area or more points can be detected. The touch sensing performance can be further enhanced by the waterproof design and digital filtering feature.

## 3.4 System Components

### 3.4.1 Reset and Clock

ESP32-S3 provides four reset levels, namely CPU Reset, Core Reset, System Reset, and Chip Reset.

- Support four reset levels:
  - CPU Reset: only resets CPU $x$  core. CPU $x$  can be CPU0 or CPU1 here. Once such reset is released, programs will be executed from CPU $x$  reset vector. Each CPU core has its own reset logic. If CPU Reset is from CPU0, the [sensitive registers](#) will be reset, too.
  - Core Reset: resets the whole digital system except RTC, including CPU0, CPU1, peripherals, Wi-Fi, Bluetooth<sup>®</sup> LE (BLE), and digital GPIOs.
  - System Reset: resets the whole digital system, including RTC.
  - Chip Reset: resets the whole chip.
- Support software reset and hardware reset:
  - Software reset is triggered by CPU $x$  configuring its corresponding registers.
  - Hardware reset is directly triggered by the circuit.

For detailed information, please refer to Chapter [Reset and Clock](#) in *ESP32-S3 Technical Reference Manual*.

### 3.4.2 Interrupt Matrix

The interrupt matrix embedded in ESP32-S3 independently allocates peripheral interrupt sources to the two CPUs' peripheral interrupts, to timely inform CPU0 or CPU1 to process the interrupts once the interrupt signals are generated. The Interrupt Matrix has the following features:

- 99 peripheral interrupt sources as input
- Generate 26 peripheral interrupts to CPU0 and 26 peripheral interrupts to CPU1 as output. Note that the remaining six CPU0 interrupts and six CPU1 interrupts are internal interrupts.
- Disable CPU non-maskable interrupt (NMI) sources
- Query current interrupt status of peripheral interrupt sources

For detailed information, please refer to Chapter [Interrupt Matrix \(INTERRUPT\)](#) in *ESP32-S3 Technical Reference Manual*.

### 3.4.3 Permission Control

In ESP32-S3, the Permission Control module is used to control access to the slaves (including internal memory, peripherals, external flash and RAM). The host can access its slave only if it has the right permission. In this way, data and instructions are protected from illegitimate read or write.

The ESP32-S3 CPU can run in both Secure World and Non-secure World where independent permission controls are adopted. The Permission Control module is able to identify which World the host is running and then proceed with its normal operations.

The Permission Control module has the following features:

- Manage access to internal memory by:
  - CPU
  - CPU trace module
  - GDMA
- Manage access to external flash and RAM by:
  - MMU
  - SPI1
  - GDMA
  - CPU through Cache
- Manage access to peripherals, supporting
  - independent permission control for each peripheral
  - monitoring non-aligned access
  - access control for customized address range
- Integrate permission lock register
  - All permission registers can be locked with the permission lock register. Once locked, the permission register and the lock register cannot be modified, unless the CPU is reset.
- Integrate permission monitor interrupt
  - In case of illegitimate access, the permission monitor interrupt will be triggered and the CPU will be informed to handle the interrupt.

### 3.4.4 System Registers

ESP32-S3 system registers can be used to control the following peripheral blocks and core modules:

- System and memory
- Clock
- Software Interrupt
- Low-power management
- Peripheral clock gating and reset
- CPU Control

For detailed information, please refer to Chapter [System Registers](#) in *ESP32-S3 Technical Reference*

Manual.

### 3.4.5 GDMA Controller

ESP32-S3 has a general-purpose DMA controller (GDMA) with five independent channels for transmitting and another five independent channels for receiving. These ten channels are shared by peripherals that have DMA feature, and support dynamic priority.

The DMA controller controls data transfer using linked lists. It allows peripheral-to-memory and memory-to-memory data transfer at a high speed. All channels can access internal and external RAM.

The ten peripherals on ESP32-S3 with DMA feature are SPI2, SPI3, UHCI0, I2S0, I2S1, LCD/CAM, AES, SHA, ADC, and RMT.

For detailed information, please refer to Chapter [GDMA Controller \(GDMA\)](#) in *ESP32-S3 Technical Reference Manual*.

### 3.4.6 CPU Clock

The CPU clock has three possible sources:

- External main crystal clock
- Internal fast RC oscillator (typically about 17.5 MHz, and adjustable)
- PLL clock

The application can select the clock source from the three clocks above. The selected clock source drives the CPU clock directly, or after division, depending on the application. Once the CPU is reset, the default clock source would be the external main crystal clock divided by 2.

**Note:**

ESP32-S3 is unable to operate without an external main crystal clock.

For more information about clocks, please refer to Chapter [Reset and Clock](#) in *ESP32-S3 Technical Reference Manual*.

### 3.4.7 RTC Clock

The RTC slow clock is used for RTC counter, RTC watchdog and low-power controller. It has three possible sources:

- External low-speed (32 kHz) crystal clock
- Internal slow RC oscillator (typically about 136 kHz, and adjustable)
- Internal fast RC oscillator divided clock (derived from the internal fast RC oscillator divided by 256)

The RTC fast clock is used for RTC peripherals and sensor controllers. It has two possible sources:

- External main crystal clock divided by 2
- Internal fast RC oscillator (typically about 17.5 MHz, and adjustable)

### 3.4.8 Clock Glitch Detection

The Clock Glitch Detection module on ESP32-S3 monitors input clock signals from XTAL\_CLK. If it detects a glitch with a width shorter than 3 ns, input clock signals from XTAL\_CLK are blocked.

For more information, please refer to Chapter [Clock Glitch Detection](#) in *ESP32-S3 Technical Reference Manual*.

## 3.5 Digital Peripherals

### 3.5.1 IO MUX and GPIO Matrix

#### GPIO Matrix Features

- A full-switching matrix between the peripheral input/output signals and the GPIO pins
- 175 digital peripheral input signals can be sourced from the input of any GPIO pins
- The output of any GPIO pins can be from any of the 184 digital peripheral output signals
- Supports signal synchronization for peripheral inputs based on APB clock bus
- Provides input signal filter
- Supports sigma delta modulated output
- Supports GPIO simple input and output

#### IO MUX Features

- Provides one configuration register `IO_MUX_GPIO $n$ _REG` for each GPIO pin. The pin can be configured to
  - perform GPIO function routed by GPIO matrix.
  - or perform direct connection bypassing GPIO matrix.
- Supports some high-speed digital signals (SPI, JTAG, UART) bypassing GPIO matrix for better high-frequency digital performance. In this case, IO MUX is used to connect these pins directly to peripherals.

#### RTC IO MUX Features

- Controls low power feature of 22 RTC GPIO pins.
- Controls analog functions of 22 RTC GPIO pins.
- Redirects 22 RTC input/output signals to RTC system.

For more information, please refer to Chapter [IO MUX and GPIO Matrix \(GPIO, IO MUX\)](#) in *ESP32-S3 Technical Reference Manual*.

### 3.5.2 Serial Peripheral Interface (SPI)

ESP32-S3 features four SPI interfaces (SPI0, SPI1, SPI2 and SPI3). SPI0 and SPI1 can be configured to operate in SPI memory mode; SPI2 and SPI3 can be configured to operate in general-purpose SPI mode.

- **SPI Memory mode**

In SPI memory mode, SPI0 and SPI1 interface with external SPI memory. Data transmission is in multiples of bytes. Up to 8-line SDR/DDR (Single Data Rate/Double Data Rate) reads and writes are supported. The clock frequency is configurable to a maximum of 120 MHz for OPI SDR/DDR mode.

- **SPI2 General-purpose SPI (GP-SPI) mode**

SPI2 can operate in master and slave modes. The master mode supports two-line full-duplex communication and single-/two-/four-/eight-line half-duplex communication. The slave mode supports two-line full-duplex communication and single-/two-/four-line half-duplex communication. The host's clock



frequency is configurable. Data transmission is in multiples of bytes. The clock polarity (CPOL) and phase (CPHA) are also configurable. The SPI2 interface supports DMA.

- In two-line full-duplex communication mode, the host's clock frequency is configurable to 80 MHz at most, and the slave's clock frequency to 60 MHz at most. Four modes of SPI transfer format are supported. Only SDR reads and writes are supported.
- In single-/two-/four-/eight-line half-duplex communication mode, the host's clock frequency is configurable to 80 MHz at most for SDR reads/writes and 40 MHz for DDR reads/writes. Four modes of SPI transfer format are supported.
- In single-/two-/four-line half-duplex communication mode, the slave's clock frequency is configurable to 60 MHz at most. Only SDR reads and writes are supported. Four modes of SPI transfer format are supported.

- **SPI3 General-purpose SPI (GP-SPI) mode**

SPI3 can operate in master and slave modes, in two-line full-duplex and single-line, two-line and four-line half-duplex communication modes. Only SDR reads and writes are supported. The host's clock frequency is configurable. Data transmission is in multiples of bytes. The clock polarity (CPOL) and phase (CPHA) are also configurable. The SPI3 interface supports DMA.

- In two-line full-duplex communication mode, the host's clock frequency is configurable to a maximum of 80 MHz, and the slave's clock frequency to a maximum of 60 MHz. Four modes of SPI transfer format are supported.
- In single-line, two-line and four-line half-duplex communication mode, the host's clock frequency is configurable to a maximum of 80 MHz, and the slave's clock frequency to 60 MHz at most. Four modes of SPI transfer format are supported.

In most cases, the data port connection between ESP32-S3 and external flash is as follows:

**Table 12: Connection Between ESP32-S3 and External Flash**

Chip Pin	External Flash Data Port			
	SPI Single-Line Mode	SPI Two-Line Mode	SPI Four-Line Mode	SPI Eight-Line Mode
SPID (SPID)	DI	IO0	IO0	IO0
SPIQ (SPIQ)	DO	IO1	IO1	IO1
SPIWP (SPIWP)	WP#	—	IO2	IO2
SPIHD (SPIHD)	HOLD#	—	IO3	IO3
GPIO33	—	—	—	IO4
GPIO34	—	—	—	IO5
GPIO35	—	—	—	IO6
GPIO36	—	—	—	IO7
GPIO37	—	—	—	DQS

### 3.5.3 LCD Interface

ESP32-S3 supports 8-bit ~16-bit parallel RGB, I8080, and MOTO6800 interfaces. These interfaces operate at 40 MHz or lower, and support conversion among RGB565, YUV422, YUV420, and YUV411.

### 3.5.4 Camera Interface

ESP32-S3 supports an 8-bit ~16-bit DVP image sensor, with clock frequency of up to 40 MHz. The camera interface supports conversion among RGB565, YUV422, YUV420, and YUV411.

### 3.5.5 UART Controller

ESP32-S3 has three UART (Universal Asynchronous Receiver Transmitter) controllers, i.e., UART0, UART1, and UART2, which support IrDA and asynchronous communication (RS232 and RS485) at a speed of up to 5 Mbps. Each UART Controller has the following features:

- Three clock sources that can be divided
- Programmable baud rate
- 1024 x 8-bit RAM shared by TX FIFOs and RX FIFOs of the three UART controllers
- Full-duplex asynchronous communication
- Automatic baud rate detection of input signals
- Data bits ranging from 5 to 8
- Stop bits of 1, 1.5, 2 or 3 bits
- Parity bit
- Special character AT\_CMD detection
- RS485 protocol
- IrDA protocol
- High-speed data communication using GDMA
- UART as wake-up source
- Software and hardware flow control

For more information, please refer to Chapter [UART Controller \(UART\)](#) in *ESP32-S3 Technical Reference Manual*.

### 3.5.6 I2C Interface

ESP32-S3 has two I2C bus interfaces which are used for I2C master mode or slave mode, depending on the user's configuration. The I2C interfaces support:

- Standard mode (100 kbit/s)
- Fast mode (400 kbit/s)
- Up to 800 kbit/s (constrained by SCL and SDA pull-up strength)
- 7-bit and 10-bit addressing mode
- Double addressing mode (slave addressing and slave register addressing)

The hardware provides a command abstraction layer to simplify the usage of the I2C peripheral.

For more information, please refer to Chapter [I2C Controller \(I2C\)](#) in *ESP32-S3 Technical Reference Manual*.

### 3.5.7 I2S Interface

ESP32-S3 includes two standard I2S interfaces. They can operate in master mode or slave mode, in full-duplex mode or half-duplex communication mode, and can be configured to operate with an 8-bit, 16-bit, 24-bit, or 32-bit resolution as an input or output channel. BCK clock frequency, from 10 kHz up to 40 MHz, is supported.

The I2S interface has a dedicated DMA controller. It supports TDM PCM, TDM MSB alignment, TDM LSB alignment, TDM Phillips, and PDM interface.

### 3.5.8 Remote Control Peripheral

The RMT (Remote Control Peripheral) module is designed to send and receive infrared remote control signals. It has the following features:

- Four TX channels
- Four RX channels
- Support multiple channels (programmable) transmitting data simultaneously
- Eight channels share a 384 x 32-bit RAM
- Support modulation on TX pulses
- Support filtering and demodulation on RX pulses
- Wrap TX mode
- Wrap RX mode
- Continuous TX mode
- DMA access for TX mode on channel 3
- DMA access for RX mode on channel 7

For more information, please refer to Chapter [Remote Control Peripheral \(RMT\)](#) in *ESP32-S3 Technical Reference Manual*.

### 3.5.9 Pulse Count Controller

The pulse count controller captures pulse and counts pulse edges through multiple modes. It has the following features:

- Four independent pulse counters (units) that count from 1 to 65535
- Each unit consists of two independent channels sharing one pulse counter
- All channels have input pulse signals (e.g. `sig_ch0_un`) with their corresponding control signals (e.g. `ctrl_ch0_un`)
- Independently filter glitches of input pulse signals (`sig_ch0_un` and `sig_ch1_un`) and control signals (`ctrl_ch0_un` and `ctrl_ch1_un`) on each unit
- Each channel has the following parameters:
  1. Selection between counting on positive or negative edges of the input pulse signal
  2. Configuration to Increment, Decrement, or Disable counter mode for control signal's high and low states

For more information, please refer to Chapter [Pulse Count Controller \(PCNT\)](#) in *ESP32-S3 Technical Reference Manual*.

Manual.

### 3.5.10 LED PWM Controller

The LED PWM controller can generate independent digital waveforms on eight channels. The LED PWM controller has the following features:

- Can generate a digital waveform with configurable periods and duty cycle. The duty cycle resolution can be up to 14 bits within a 1 ms period.
- Has multiple clock sources, including APB clock and external main crystal clock.
- Can operate when the CPU is in Light-sleep mode.
- Supports gradual increase or decrease of duty cycle, which is useful for the LED RGB color-fading generator.

For more information, please refer to Chapter [LED PWM Controller \(LEDC\)](#) in *ESP32-S3 Technical Reference Manual*.

### 3.5.11 USB 2.0 OTG Full-Speed Interface

ESP32-S3 features a full-speed USB OTG interface along with an integrated transceiver. The USB OTG interface complies with the USB 2.0 specification. It has the following features:

#### General Features

- FS and LS data rates
- HNP and SRP as A-device or B-device
- Dynamic FIFO (DFIFO) sizing
- Multiple modes of memory access
  - Scatter/Gather DMA mode
  - Buffer DMA mode
  - Slave mode
- Can choose integrated transceiver or external transceiver
- Utilizing integrated transceiver with USB Serial/JTAG by time-division multiplexing when only integrated transceiver is used
- Support USB OTG using one of the transceivers while USB Serial/JTAG using the other one when both integrated transceiver or external transceiver are used

#### Device Mode Features

- Endpoint number 0 always present (bi-directional, consisting of EP0 IN and EP0 OUT)
- Six additional endpoints (endpoint numbers 1 to 6), configurable as IN or OUT
- Maximum of five IN endpoints concurrently active at any time (including EP0 IN)
- All OUT endpoints share a single RX FIFO
- Each IN endpoint has a dedicated TX FIFO

#### Host Mode Features

- 8 channels (pipes)

- A control pipe consists of two channels (IN and OUT), as IN and OUT transactions must be handled separately. Only Control transfer type is supported.
- Each of the other seven channels is dynamically configurable to be IN or OUT, and supports Bulk, Isochronous, and Interrupt transfer types.
- All channels share an RX FIFO, non-periodic TX FIFO, and periodic TX FIFO. The size of each FIFO is configurable.

For more information, please refer to Chapter [USB On-The-Go \(USB\)](#) in *ESP32-S3 Technical Reference Manual*.

### 3.5.12 USB Serial/JTAG Controller

ESP32-S3 integrates a USB Serial/JTAG controller that supports the following features:

- USB Full-speed device.
- Can be configured to either use internal USB PHY of ESP32-S3 or external PHY via GPIO matrix.
- Fixed function device, hardwired for CDC-ACM (Communication Device Class - Abstract Control Model) and JTAG adapter functionality.
- 2 OUT Endpoints, 3 IN Endpoints in addition to Control Endpoint 0; Up to 64-byte data payload size.
- Internal PHY, so no or very few external components needed to connect to a host computer.
- CDC-ACM adherent serial port emulation is plug-and-play on most modern OSes.
- JTAG interface allows fast communication with CPU debug core using a compact representation of JTAG instructions.
- CDC-ACM supports host controllable chip reset and entry into download mode.

For more information, please refer to Chapter [USB Serial/JTAG Controller \(USB\\_SERIAL\\_JTAG\)](#) in *ESP32-S3 Technical Reference Manual*.

### 3.5.13 Motor Control PWM (MCPWM)

ESP32-S3 integrates two MCPWM that can be used to drive digital motors and smart light. Each MCPWM peripheral has one clock divider (prescaler), three PWM timers, three PWM operators, and a capture module. PWM timers are used for generating timing references. The PWM operators generate desired waveform based on the timing references. Any PWM operator can be configured to use the timing references of any PWM timers. Different PWM operators can use the same PWM timer's timing references to produce related PWM signals. PWM operators can also use different PWM timers' values to produce the PWM signals that work alone. Different PWM timers can also be synchronized together.

For more information, please refer to Chapter [Motor Control PWM \(MCPWM\)](#) in *ESP32-S3 Technical Reference Manual*.

### 3.5.14 SD/MMC Host Controller

ESP32-S3 has an SD/MMC Host Controller with the following features:

- Secure Digital (SD) memory version 3.0 and version 3.01
- Secure Digital I/O (SDIO) version 3.0
- Consumer Electronics Advanced Transport Architecture (CE-ATA) version 1.1
- Multimedia Cards (MMC version 4.41, eMMC version 4.5 and version 4.51)

- Up to 80 MHz clock output
- Three data bus modes:
  - 1-bit
  - 4-bit (supports two SD/SDIO/MMC 4.41 cards, and one SD card operating at 1.8 V in 4-bit mode)
  - 8-bit

For more information, please refer to Chapter [SD/MMC Host Controller \(SDHOST\)](#) in *ESP32-S3 Technical Reference Manual*.

### 3.5.15 TWAI® Controller

The Two-wire Automotive Interface (TWAI) is a multi-master, multi-cast communication protocol with error detection and signaling as well as inbuilt message priorities and arbitration. The TWAI controller in ESP32-S3 supports the following features:

- Compatible with ISO 11898-1 protocol (CAN Specification 2.0)
- Standard frame format (11-bit ID) and extended frame format (29-bit ID)
- Bit rates from 1 Kbit/s to 1 Mbit/s
- Multiple modes of operation:
  - Normal
  - Listen Only
  - Self-Test (no acknowledgment required)
- 64-byte receive FIFO
- Acceptance filter (single and dual filter modes)
- Error detection and handling:
  - Error counters
  - Configurable error interrupt threshold
  - Error code capture
  - Arbitration lost capture

For more information, please refer to Chapter [Two-wire Automotive Interface \(TWAI®\)](#) in *ESP32-S3 Technical Reference Manual*.

## 3.6 Radio and Wi-Fi

The ESP32-S3 radio consists of the following blocks:

- 2.4 GHz receiver
- 2.4 GHz transmitter
- Bias and regulators
- Balun and transmit-receive switch
- Clock generator

### 3.6.1 2.4 GHz Receiver

The 2.4 GHz receiver demodulates the 2.4 GHz RF signal to quadrature baseband signals and converts them to the digital domain with two high-resolution, high-speed ADCs. To adapt to varying signal channel conditions, ESP32-S3 integrates RF filters, Automatic Gain Control (AGC), DC offset cancelation circuits, and baseband filters.

### 3.6.2 2.4 GHz Transmitter

The 2.4 GHz transmitter modulates the quadrature baseband signals to the 2.4 GHz RF signal, and drives the antenna with a high-powered CMOS power amplifier. The use of digital calibration further improves the linearity of the power amplifier.

To compensate for receiver imperfections, additional calibration methods are built into the chip, including:

- Carrier leakage compensation
- I/Q amplitude/phase matching
- Baseband nonlinearities suppression
- RF nonlinearities suppression
- Antenna matching

These built-in calibration routines reduce the cost and time to the market for your product, and eliminate the need for specialized testing equipment.

### 3.6.3 Clock Generator

The clock generator produces quadrature clock signals of 2.4 GHz for both the receiver and the transmitter. All components of the clock generator are integrated into the chip, including inductors, varactors, filters, regulators, and dividers.

The clock generator has built-in calibration and self-test circuits. Quadrature clock phases and phase noise are optimized on chip with patented calibration algorithms which ensure the best performance of the receiver and the transmitter.

### 3.6.4 Wi-Fi Radio and Baseband

The ESP32-S3 Wi-Fi radio and baseband support the following features:

- 802.11b/g/n
- 802.11n MCS0-7 that supports 20 MHz and 40 MHz bandwidth
- 802.11n MCS32
- 802.11n 0.4  $\mu$ s guard-interval
- Data rate up to 150 Mbps
- RX STBC (single spatial stream)
- Adjustable transmitting power
- Antenna diversity:

ESP32-S3 supports antenna diversity with an external RF switch. This switch is controlled by one or more GPIOs, and used to select the best antenna to minimize the effects of channel imperfections.

### 3.6.5 Wi-Fi MAC

ESP32-S3 implements the full 802.11 b/g/n Wi-Fi MAC protocol. It supports the Basic Service Set (BSS) STA and SoftAP operations under the Distributed Control Function (DCF). Power management is handled automatically with minimal host interaction to minimize the active duty period.

The ESP32-S3 Wi-Fi MAC applies the following low-level protocol functions automatically:

- 4 × virtual Wi-Fi interfaces
- Simultaneous Infrastructure BSS Station mode, SoftAP mode, and Station + SoftAP mode
- RTS protection, CTS protection, Immediate Block ACK
- Fragmentation and defragmentation
- TX/RX A-MPDU, TX/RX A-MSDU
- TXOP
- WMM
- GCMP, CCMP, TKIP, WAPI, WEP, and BIP
- Automatic beacon monitoring (hardware TSF)
- 802.11mc FTM

### 3.6.6 Networking Features

Users are provided with libraries for TCP/IP networking, ESP-WIFI-MESH networking, and other networking protocols over Wi-Fi. TLS 1.2 support is also provided.

## 3.7 Bluetooth LE

ESP32-S3 includes a Bluetooth Low Energy subsystem that integrates a hardware link layer controller, an RF/modem block and a feature-rich software protocol stack. It supports the core features of Bluetooth 5 and Bluetooth mesh.

### 3.7.1 Bluetooth LE Radio and PHY

Bluetooth Low Energy radio and PHY in ESP32-S3 support:

- 1 Mbps PHY
- 2 Mbps PHY for high transmission speed and high data throughput
- Coded PHY for high RX sensitivity and long range (125 Kbps and 500 Kbps)
- Class 1 transmit power without external PA
- Listen before talk (LBT), implemented in hardware
- Antenna diversity with an external RF switch. This switch is controlled by one or more GPIOs, and used to select the best antenna to minimize the effects of channel imperfections.

### 3.7.2 Bluetooth LE Link Layer Controller

Bluetooth Low Energy Link Layer Controller in ESP32-S3 supports:

- LE advertising extensions, to enhance broadcasting capacity and broadcast more intelligent data
- Multiple advertisement sets



- Simultaneous advertising and scanning
- Multiple connections in simultaneous central and peripheral roles
- Adaptive frequency hopping and channel assessment
- LE channel selection algorithm #2
- Connection parameter update
- High duty cycle non-connectable advertising
- LE privacy 1.2
- LE data packet length extension
- Link layer extended scanner filter policies
- Low duty cycle directed advertising
- Link layer encryption
- LE Ping

## 3.8 Timers and Watchdogs

### 3.8.1 General Purpose Timers

ESP32-S3 is embedded with four 54-bit general-purpose timers, which are based on 16-bit prescalers and 54-bit auto-reload-capable up/down-timers.

The timers' features are summarized as follows:

- A 16-bit clock prescaler, from 2 to 65536
- A 54-bit time-base counter programmable to be incrementing or decrementing
- Able to read real-time value of the time-base counter
- Halting and resuming the time-base counter
- Programmable alarm generation
- Timer value reload (Auto-reload at alarm or software-controlled instant reload)
- Level interrupt generation

For more information, please refer to Chapter [Timer Group \(TIMG\)](#) in *ESP32-S3 Technical Reference Manual*.

### 3.8.2 System Timer

ESP32-S3 integrates a 52-bit system timer, which has two 52-bit counters and three comparators. The system timer has the following features:

- Counters with a clock frequency of 16 MHz
- Three types of independent interrupts generated according to alarm value
- Two alarm modes: target mode and period mode
- 52-bit target alarm value and 26-bit periodic alarm value
- Read sleep time from RTC timer when the chip is awoken from Deep-sleep or Light-sleep mode
- Counters can be stalled if the CPU is stalled or in OCD mode

For more information, please refer to Chapter [System Timer \(SYSTIMER\)](#) in *ESP32-S3 Technical Reference Manual*.

### 3.8.3 Watchdog Timers

The ESP32-S3 contains three watchdog timers: one in each of the two timer groups (called Main System Watchdog Timers, or MWDT) and one in the RTC Module (called the RTC Watchdog Timer, or RWDT).

During the flash boot process, RWDT and the first MWDT are enabled automatically in order to detect and recover from booting errors.

Watchdog timers have the following features:

- Four stages, each with a programmable timeout value. Each stage can be configured, enabled and disabled separately
- Interrupt, CPU reset, or core reset for MWDT upon expiry of each stage; interrupt, CPU reset, core reset, or system reset for RWDT upon expiry of each stage
- 32-bit expiry counter
- Write protection, to prevent RWDT and MWDT configuration from being altered inadvertently
- Flash boot protection  
If the boot process from an SPI flash does not complete within a predetermined period of time, the watchdog will reboot the entire main system.

For more information, please refer to Chapter [Watchdog Timers](#) in *ESP32-S3 Technical Reference Manual*.

### 3.8.4 XTAL32K Watchdog Timers

#### Interrupt and Wake-Up

When the XTAL32K watchdog timer detects the oscillation failure of XTAL32K\_CLK, an oscillation failure interrupt RTC\_XTAL32K\_DEAD\_INT (for interrupt description, please refer to [ESP32-S3 Technical Reference Manual](#)) is generated. At this point, the CPU will be woken up if in Light-sleep mode or Deep-sleep mode.

#### BACKUP32K\_CLK

Once the XTAL32K watchdog timer detects the oscillation failure of XTAL32K\_CLK, it replaces XTAL32K\_CLK with BACKUP32K\_CLK (with a frequency of 32 kHz or so) derived from RTC\_CLK as RTC's SLOW\_CLK, so as to ensure proper functioning of the system.

For more information, please refer to Chapter [XTAL32K Watchdog Timers \(XTWDT\)](#) in *ESP32-S3 Technical Reference Manual*.

## 3.9 Cryptography/Security Components

### 3.9.1 External Memory Encryption and Decryption

ESP32-S3 integrates an External Memory Encryption and Decryption module that complies with the XTS-AES standard. It supports the following features:

- General XTS\_AES algorithm, compliant with IEEE Std 1619-2007
- Software-based manual encryption
- High-speed auto encryption, without software's participation
- High-speed auto decryption, without software's participation

- Encryption and decryption functions jointly determined by registers configuration, eFuse parameters, and boot mode

For more information, please refer to Chapter [External Memory Encryption and Decryption \(XTS\\_AES\)](#) in *ESP32-S3 Technical Reference Manual*.

### 3.9.2 Secure Boot

Secure Boot feature uses a hardware root of trust to ensure only signed firmware (with RSA-PSS signature) can be booted.

### 3.9.3 HMAC Accelerator

The Hash-based Message Authentication Code (HMAC) module computes Message Authentication Codes (MACs) using Hash algorithm and keys as described in RFC 2104. The HMAC Accelerator in ESP32-S3 supports the following features:

- Standard HMAC-SHA-256 algorithm
- Hash result only accessible by configurable hardware peripheral (in downstream mode)
- Compatible to challenge-response authentication algorithm
- Generates required keys for the Digital Signature (DS) peripheral (in downstream mode)
- Re-enables soft-disabled JTAG (in downstream mode)

For more information, please refer to Chapter [HMAC Accelerator \(HMAC\)](#) in *ESP32-S3 Technical Reference Manual*.

### 3.9.4 Digital Signature

A Digital Signature is used to verify the authenticity and integrity of a message using a cryptographic algorithm. The Digital Signature (DS) in ESP32-S3 supports the following features:

- RSA Digital Signatures with key length up to 4096 bits
- Encrypted private key data, only decryptable by DS peripheral
- SHA-256 digest to protect private key data against tampering by an attacker

For more information, please refer to Chapter [Digital Signature \(DS\)](#) in *ESP32-S3 Technical Reference Manual*.

### 3.9.5 World Controller

The ESP32-S3 can divide the hardware and software resources into a Secure World and a Non-Secure World to prevent sabotage or access to device information. Switching between the two worlds is performed by the World Controller, which supports the following features:

- Control of the CPU switching between secure and non-secure worlds
- Control of 15 DMA peripherals switching between secure and non-secure worlds
- Record of CPU's world switching logs
- Shielding of the CPU's NMI interrupt

### 3.9.6 SHA Accelerator

ESP32-S3 integrates an SHA accelerator, which is a hardware device that speeds up SHA algorithm significantly. The SHA Accelerator supports the following features:

- All the hash algorithms introduced in [FIPS PUB 180-4 Spec.](#)
  - SHA-1
  - SHA-224
  - SHA-256
  - SHA-384
  - SHA-512
  - SHA-512/224
  - SHA-512/256
  - SHA-512/t
- Two working modes
  - Typical SHA
  - DMA-SHA
- interleaved function when working in Typical SHA working mode
- Interrupt function when working in DMA-SHA working mode

For more information, please refer to Chapter [SHA Accelerator \(SHA\)](#) in *ESP32-S3 Technical Reference Manual*.

### 3.9.7 AES Accelerator

ESP32-S3 integrates an Advanced Encryption Standard (AES) Accelerator, which is a hardware device that speeds up AES Algorithm significantly. The AES Accelerator supports the following features:

- Typical AES working mode
  - AES-128/AES-256 encryption and decryption
- DMA-AES working mode
  - AES-128/AES-256 encryption and decryption
  - Block cipher mode
    - \* ECB (Electronic Codebook)
    - \* CBC (Cipher Block Chaining)
    - \* OFB (Output Feedback)
    - \* CTR (Counter)
    - \* CFB8 (8-bit Cipher Feedback)
    - \* CFB128 (128-bit Cipher Feedback)
  - Interrupt on completion of computation

For more information, please refer to Chapter [AES Accelerator \(AES\)](#) in *ESP32-S3 Technical Reference Manual*.

### 3.9.8 RSA Accelerator

The RSA Accelerator provides hardware support for high precision computation used in various RSA asymmetric cipher algorithms. The RSA Accelerator in ESP32-S3 supports the following features:

- Large-number modular exponentiation with two optional acceleration options
- Large-number modular multiplication
- Large-number multiplication
- Operands of different lengths
- Interrupt on completion of computation

For more information, please refer to Chapter [RSA Accelerator \(RSA\)](#) in *ESP32-S3 Technical Reference Manual*.

### 3.9.9 Random Number Generator

The random number generator in ESP32-S3 generates true random numbers, which means random number generated from a physical process, rather than by means of an algorithm. No number generated within the specified range is more or less likely to appear than any other number.

For more information, please refer to Chapter [Random Number Generator \(RNG\)](#) in *ESP32-S3 Technical Reference Manual*.

## 3.10 Peripheral Pin Configurations

Table 13: Peripheral Pin Configurations

Interface	Signal	Pin	Function
ADC	ADC1_CH0	GPIO1	Two 12-bit SAR ADCs
	ADC1_CH1	GPIO2	
	ADC1_CH2	GPIO3	
	ADC1_CH3	GPIO4	
	ADC1_CH4	GPIO5	
	ADC1_CH5	GPIO6	
	ADC1_CH6	GPIO7	
	ADC1_CH7	GPIO8	
	ADC1_CH8	GPIO9	
	ADC1_CH9	GPIO10	
	ADC2_CH0	GPIO11	
	ADC2_CH1	GPIO12	
	ADC2_CH2	GPIO13	
	ADC2_CH3	GPIO14	
	ADC2_CH4	XTAL_32K_P	
	ADC2_CH5	XTAL_32K_N	
	ADC2_CH6	GPIO17	
	ADC2_CH7	GPIO18	
	ADC2_CH8	GPIO19	
ADC2_CH9	GPIO20		

Interface	Signal	Pin	Function
Touch sensor	TOUCH1	GPIO1	Capacitive touch sensors
	TOUCH2	GPIO2	
	TOUCH3	GPIO3	
	TOUCH4	GPIO4	
	TOUCH5	GPIO5	
	TOUCH6	GPIO6	
	TOUCH7	GPIO7	
	TOUCH8	GPIO8	
	TOUCH9	GPIO9	
	TOUCH10	GPIO10	
	TOUCH11	GPIO11	
	TOUCH12	GPIO12	
	TOUCH13	GPIO13	
	TOUCH14	GPIO14	
JTAG	MTDI	MTDI	JTAG for software debugging
	MTCK	MTCK	
	MTMS	MTMS	
	MTDO	MTDO	
UART	U0RXD_in	Any GPIO pins	Three UART devices with hardware flow-control and DMA
	U0CTS_in		
	U0DSR_in		
	U0TXD_out		
	U0RTS_out		
	U0DTR_out		
	U1RXD_in		
	U1CTS_in		
	U1DSR_in		
	U1TXD_out		
	U1RTS_out		
	U1DTR_out		
	U2RXD_in		
	U2CTS_in		
	U2DSR_in		
	U2TXD_out		
U2RTS_out			
U2DTR_out			
I2C	I2CEXT0_SCL_in/_out	Any GPIO pins	Two I2C devices in slave or master mode
	I2CEXT0_SDA_in/_out		
	I2CEXT1_SCL_in/_out		
	I2CEXT1_SDA_in/_out		
LED PWM	LEDC_LS_SIG_out0~7	Any GPIO pins	Eight independent channels.

Interface	Signal	Pin	Function
I2S	I2S00_BCK_in	Any GPIO pins	Stereo input and output from/to the audio codec
	I2S0_MCLK_in		
	I2S00_WS_in		
	I2S0I_SD_in		
	I2S0I_SD1_in		
	I2S0I_SD2_in		
	I2S0I_SD3_in		
	I2S0I_BCK_in		
	I2S0I_WS_in		
	I2S10_BCK_in		
	I2S1_MCLK_in		
	I2S10_WS_in		
	I2S1I_SD_in		
	I2S1I_BCK_in		
	I2S1I_WS_in		
	I2S00_BCK_out		
	I2S0_MCLK_out		
	I2S00_WS_out		
	I2S00_SD_out		
	I2S00_SD1_out		
	I2S0I_BCK_out		
	I2S0I_WS_out		
	I2S10_BCK_out		
	I2S1_MCLK_out		
I2S10_WS_out			
I2S10_SD_out			
I2S1I_BCK_out			
I2S1I_WS_out			
LCD_CAMERA	LCD_PCLK	Any GPIO pins	8 ~16 data transmission to LCD interface and 8 ~16 data reception by camera interface
	LCD_DC		
	LCD_V_SYNC		
	LCD_H_SYNC		
	LCD_H_ENABLE		
	LCD_DATA_out0~15		
	LCD_CS		
	CAM_CLK		
	CAM_V_SYNC		
	CAM_H_SYNC		
	CAM_H_ENABLE		
	CAM_PCLK		
	CAM_DATA_in0~15		
Remote Control Peripheral	RMT_SIG_in0~3	Any GPIO pins	Four channels for an IR transceiver of various wave forms
	RMT_SIG_out0~3		

Interface	Signal	Pin	Function
SPI0/1	SPICLK_out_mux	SPICLK	Support Standard SPI, Dual SPI, QSPI, QPI, OSPI, and OPI that allow connection to external flash and RAM.
	SPICS0_out	SPICS0	
	SPICS1_out	SPICS1	
	SPID_in/_out	SPID	
	SPIQ_in/_out	SPIQ	
	SPIWP_in/_out	SPIWP	
	SPIHD_in/_out	SPIHD	
	SPID4_in/_out	GPIO33	
	SPID5_in/_out	GPIO34	
	SPID6_in/_out	GPIO35	
	SPID7_in/_out	GPIO36	
	SPIDQS_in/_out	GPIO37	
SPI2	FSPICLK_in/_out_mux	Any GPIO pins	Support: <ul style="list-style-type: none"> <li>• master mode of SPI, Dual SPI, Quad SPI, Octal SPI, QPI, and OPI, and slave mode of SPI, Dual SPI, Quad SPI, and QPI;</li> <li>• connection to external flash, RAM, and other SPI devices;</li> <li>• four modes of SPI transfer format;</li> <li>• configurable SPI frequency;</li> <li>• 64-byte FIFO or DMA buffer.</li> </ul>
	FSPICS0_in/_out		
	FSPICS1~5_out		
	FSPID_in/_out		
	FSPIQ_in/_out		
	FSPIWP_in/_out		
	FSPIHD_in/_out		
	FSPIIO4~7_in/_out		
	FSPIDQS_out		
SPI3	SPI3_CLK_in/_out_mux	Any GPIO pins	Support: <ul style="list-style-type: none"> <li>• master and slave modes of SPI, Dual SPI, Quad SPI, and QPI;</li> <li>• four modes of SPI transfer format;</li> <li>• configurable frequency;</li> <li>• 64-byte FIFO or DMA buffer.</li> </ul>
	SPI3_CS0_in/_out		
	SPI3_CS1_out		
	SPI3_CS2_out		
	SPI3_D_in/_out		
	SPI3_Q_in/_out		
	SPI3_WP_in/_out		
	SPI3_HD_in/_out		
Pulse counter	PCNT_SIG_CH0_in0~3	Any GPIO pins	Capture pulse and count pulse edges in seven modes
	PCNT_SIG_CH1_in0~3		
	PCNT_CTRL_CH0_in0~3		
	PCNT_CTRL_CH1_in0~3		



Interface	Signal	Pin	Function
USB OTG	D-	GPIO19 (for internal PHY)	Full-speed USB OTG (USB OTG supports both full-speed on-chip PHY and external PHY)
	D+	GPIO20 (for internal PHY)	
	VP	MTMS (for external PHY)	
	VM	MTDI (for external PHY)	
	RCV	GPIO21 (for external PHY)	
	OEN	MTDO (for external PHY)	
	VPO	MTCK (for external PHY)	
	VMO	GPIO38 (for external PHY)	
USB Serial/JTAG controller	D-	GPIO19 (for internal PHY)	Flash programming and CPU debugging (USB Serial/JTAG controller supports both full-speed on-chip PHY and external PHY)
	D+	GPIO20 (for internal PHY)	
	VP	MTMS (for external PHY)	
	VM	MTDI (for external PHY)	
	OEN	MTDO (for external PHY)	
	VPO	MTCK (for external PHY)	
	VMO	GPIO38 (for external PHY)	
SD/MMC Host Controller	SDHOST_CCLK_out_1~2	Any GPIO pins	Secure Digital (SD) memory version 3.0.1 supported
	SDHOST_RST_N_1~2		
	SD-HOST_CCMD_OD_PULLUP_EN_N		
	SDIO_TOHOST_INT_out		
	SDHOST_CCMD_in/_out_1		
	SDHOST_CCMD_in/_out_2		
	SDHOST_CDATA_in/_out_10		
	SDHOST_CDATA_in/_out_11		
	SDHOST_CDATA_in/_out_12		
	SDHOST_CDATA_in/_out_13		
	SDHOST_CDATA_in/_out_14		
	SDHOST_CDATA_in/_out_15		
	SDHOST_CDATA_in/_out_16		
	SDHOST_CDATA_in/_out_17		
	SDHOST_CDATA_in/_out_20		
	SDHOST_CDATA_in/_out_21		
	SDHOST_CDATA_in/_out_22		
	SDHOST_CDATA_in/_out_23		
	SDHOST_CDATA_in/_out_24		
	SDHOST_CDATA_in/_out_25		
	SDHOST_CDATA_in/_out_26		
	SDHOST_CDATA_in/_out_27		
	SDHOST_DATA_STROBE_1~2		
SDHOST_CARD_DETECT_N_1~2			
SD-HOST_CARD_WRITE_PRT_1~2			
SDHOST_CARD_INT_N_1~2			

Interface	Signal	Pin	Function
MCPWM	PWM0_SYNC0~2_in	Any GPIO pins	Two MCPWM input and output pins. Signals include PWM differential output signals, fault input signals to be detected, input signals to be captured, and external clock synchronization signals
	PWM0_F0~2_in		
	PWM0_CAP0~2_in		
	PWM1_SYNC0~2_in		
	PWM1_F0~2_in		
	PWM1_CAP0~2_in		
	PWM0_out0a		
	PWM0_out0b		
	PWM0_out1a		
	PWM0_out1b		
	PWM0_out2a		
	PWM0_out2b		
	PWM1_out0a		
	PWM1_out0b		
	PWM1_out1a		
	PWM1_out1b		
	PWM1_out2a		
PWM1_out2b			
TWAI® Controller	TWAI_RX	Any GPIO pins	Compatible with ISO 11898-1 protocol (CAN Specification 2.0). Data rate up to 1 Mbit/s
	TWAI_TX		
	TWAI_BUS_OFF_ON		
	TWAI_CLKOUT		

## 4. Electrical Characteristics

### 4.1 Absolute Maximum Ratings

Stresses beyond the absolute maximum ratings listed in the table below may cause permanent damage to the device. These are stress ratings only, and do not refer to the functional operation of the device.

Table 14: Absolute Maximum Ratings

Symbol	Parameter	Min	Max	Unit
VDDA, VDD3P3, VDD3P3_RTC, VDD3P3_CPU, VDD_SPI	Voltage applied to power supply pins per power domain	-0.3	3.6	V
$I_{output}^*$	Cumulative IO output current	—	1500	mA
$T_{STORE}$	Storage temperature	-40	150	°C

\* The chip worked properly after a 24-hour test in ambient temperature at 25 °C, and the IOs in three domains (VDD3P3\_RTC, VDD3P3\_CPU, VDD\_SPI) output high logic level to ground.

### 4.2 Recommended Operating Conditions

Table 15: Recommended Operating Conditions

Symbol	Parameter	Min	Typ	Max	Unit	
VDDA, VDD3P3 VDD3P3_RTC	Voltage applied to power supply pins per power domain	3.0	3.3	3.6	V	
VDD_SPI (working as input power supply) <sup>1</sup>	—	1.8	3.3	3.6	V	
VDD3P3_CPU <sup>2,3</sup>	Voltage applied to power supply pin	3.0	3.3	3.6	V	
$I_{VDD}$ <sup>4</sup>	Current delivered by external power supply	0.5	—	—	A	
$T_A$	Ambient temperature	ESP32-S3	-40	—	105	°C
		ESP32-S3FN8			85	
		ESP32-S3R2			85	
		ESP32-S3R8			65	
		ESP32-S3R8V			65	

<sup>1</sup> For more information, please refer to Section 2.7 *Power Scheme*.

<sup>2</sup> When writing to eFuses, VDD3P3\_CPU should not exceed 3.3 V.

<sup>3</sup> When VDD\_SPI is used to drive peripherals, VDD3P3\_CPU should comply with the peripherals' specifications. For more information, please refer to Table 16.

<sup>4</sup> If you use a single power supply, the recommended output current is 500 mA or more.

### 4.3 VDD\_SPI Output Characteristics

Table 16: VDD\_SPI Output Characteristics

Symbol	Parameter	Typ	Unit
$R_{SPI}$	On-resistance in 3.3 V mode	14	$\Omega$
$I_{SPI}$	Output current in 1.8 V mode	40	mA

In real-life applications, when VDD\_SPI works in 3.3 V output mode, VDD3P3\_CPU may be affected by  $R_{SPI}$ . For example, when VDD3P3\_CPU is used to drive a 3.3 V flash, it should comply with the following specifications:

$$VDD3P3\_CPU > VDD\_flash\_min + I\_flash\_max * R_{SPI}$$

Among which, VDD\_flash\_min is the minimum operating voltage of the flash, and I\_flash\_max the maximum current.

For more information, please refer to section [2.7 Power Scheme](#).

## 4.4 DC Characteristics (3.3 V, 25 °C)

Table 17: DC Characteristics (3.3 V, 25 °C)

Symbol	Parameter	Min	Typ	Max	Unit
$C_{IN}$	Pin capacitance	—	2	—	pF
$V_{IH}$	High-level input voltage	$0.75 \times VDD^1$	—	$VDD^1 + 0.3$	V
$V_{IL}$	Low-level input voltage	-0.3	—	$0.25 \times VDD^1$	V
$I_{IH}$	High-level input current	—	—	50	nA
$I_{IL}$	Low-level input current	—	—	50	nA
$V_{OH}^2$	High-level output voltage	$0.8 \times VDD^1$	—	—	V
$V_{OL}^2$	Low-level output voltage	—	—	$0.1 \times VDD^1$	V
$I_{OH}$	High-level source current (VDD <sup>1</sup> = 3.3 V, $V_{OH} \geq 2.64$ V, PAD_DRIVER = 3)	—	40	—	mA
$I_{OL}$	Low-level sink current (VDD <sup>1</sup> = 3.3 V, $V_{OL} = 0.495$ V, PAD_DRIVER = 3)	—	28	—	mA
$R_{PU}$	Internal weak pull-up resistor	—	45	—	k $\Omega$
$R_{PD}$	Internal weak pull-down resistor	—	45	—	k $\Omega$
$V_{IH\_nRST}$	Chip reset release voltage (CHIP_PU voltage is within the specified range)	$0.75 \times VDD^1$	—	$VDD^1 + 0.3$	V
$V_{IL\_nRST}$	Chip reset voltage (CHIP_PU voltage is within the specified range)	-0.3	—	$0.25 \times VDD^1$	V

<sup>1</sup> VDD is the I/O voltage for a particular power domain of pins.

<sup>2</sup>  $V_{OH}$  and  $V_{OL}$  are measured using high-impedance load.

## 4.5 ADC Characteristics

Table 18: ADC Characteristics

Symbol	Parameter	Min	Max	Unit
DNL (Differential nonlinearity) <sup>1</sup>	ADC connected to an external 100 nF capacitor; DC signal input; Ambient temperature at 25 °C; Wi-Fi off	-4	4	LSB
INL (Integral nonlinearity)		-8	8	LSB
Sampling rate	—	—	100	kSPS <sup>2</sup>

<sup>1</sup> To get better DNL results, you can sample multiple times and apply a filter, or calculate the average value.

<sup>2</sup> kSPS means kilo samples-per-second.

ESP-IDF provides couple of [calibration methods](#) for ADC. Results after calibration using hardware + software calibration are shown in Table 19. For higher accuracy, users may apply other calibration methods provided in ESP-IDF, or implement their own.

**Table 19: ADC Calibration Results**

Parameter	Description	Min	Max	Unit
Total error	ATTEN0, effective measurement range of 0 ~ 950	-5	5	mV
	ATTEN1, effective measurement range of 0 ~ 1250	-6	6	mV
	ATTEN2, effective measurement range of 0 ~ 1750	-10	10	mV
	ATTEN3, effective measurement range of 0 ~ 3100	-50	50	mV

## 4.6 Current Consumption

The current consumption measurements are taken with a 3.3 V supply at 25 °C of ambient temperature at the RF port. All transmitters' measurements are based on a 100% duty cycle.

**Table 20: Wi-Fi Current Consumption Depending on RF Modes**

Work Mode <sup>1</sup>	Description	Peak (mA)	
Active (RF working)	TX	802.11b, 1 Mbps, @21 dBm	340
		802.11g, 54 Mbps, @19 dBm	291
		802.11n, HT20, MCS7, @18.5 dBm	283
		802.11n, HT40, MCS7, @18 dBm	286
	RX	802.11b/g/n, HT20	88
		802.11n, HT40	91

<sup>1</sup> The CPU work mode: Single core runs 32-bit data access instructions at 80 MHz, the other core is in idle state.

Note that data in Table 21 only applies to ESP32-S3, with no SiP flash or SiP PSRAM co-packaged inside.

**Table 21: Current Consumption Depending on Work Modes (except Modem-sleep)**

Work mode	Description	Typ	Unit
Light-sleep	—	240	μA
Deep-sleep	RTC memory and RTC peripherals are powered on.	8	μA
	RTC memory is powered on. RTC peripherals are powered off.	7	μA
Power off	CHIP_PU is set to low level. The chip is powered off.	1	μA

Table 22: Current Consumption in Modem-sleep Mode

Work mode	Frequency (MHz)	Description	Typ <sup>1</sup> (mA)	Typ <sup>2</sup> (mA)
Modem-sleep	40	WAITI (Dual core in idle state)	13.2	18.8
		Single core running 32-bit data access instructions, the other core in idle state	16.2	21.8
		Dual core running 32-bit data access instructions	18.7	24.4
		Single core running 128-bit data access instructions, the other core in idle state	19.9	25.4
		Dual core running 128-bit data access instructions	23.0	28.8
	80	WAITI	22.0	36.1
		Single core running 32-bit data access instructions, the other core in idle state	28.4	42.6
		Dual core running 32-bit data access instructions	33.1	47.3
		Single core running 128-bit data access instructions, the other core in idle state	35.1	49.6
		Dual core running 128-bit data access instructions	41.8	56.3
	160	WAITI	27.6	42.3
		Single core running 32-bit data access instructions, the other core in idle state	39.9	54.6
		Dual core running 32-bit data access instructions	49.6	64.1
		Single core running 128-bit data access instructions, the other core in idle state	54.4	69.2
		Dual core running 128-bit data access instructions	66.7	81.1
	240	WAITI	32.9	47.6
		Single core running 32-bit data access instructions, the other core in idle state	51.2	65.9
		Dual core running 32-bit data access instructions	66.2	81.3
		Single core running 128-bit data access instructions, the other core in idle state	72.4	87.9
		Dual core running 128-bit data access instructions	91.7	107.9

<sup>1</sup> Current consumption when all peripherals and peripheral clocks are **disabled**.

<sup>2</sup> Current consumption when all peripherals and peripheral clocks are **enabled**.

<sup>3</sup> In actual scenarios, the current of peripherals may vary in different operating conditions.

## 4.7 Reliability

Table 23: Reliability Qualifications

Test Item	Test Conditions	Test Standard
HTOL (High Temperature Operating Life)	125 °C, 1000 hours	JESD22-A108
ESD (Electro-Static Discharge Sensitivity)	HBM (Human Body Mode) <sup>1</sup> ± 2000 V	JS-001
	CDM (Charge Device Mode) <sup>2</sup> ± 1000 V	JS-002

Cont'd on next page

Table 23 – cont'd from previous page

Test Item	Test Conditions	Test Standard
Latch up	Current trigger $\pm 200$ mA	JESD78
	Voltage trigger $1.5 \times VDD_{max}$	
Preconditioning	Bake 24 hours @125 °C Moisture soak (level 3: 192 hours @30 °C, 60% RH) IR reflow solder: 260 + 0 °C, 20 seconds, three times	J-STD-020, JESD47, JESD22-A113
TCT (Temperature Cycling Test)	-65 °C / 150 °C, 500 cycles	JESD22-A104
uHAST (Highly Accelerated Stress Test, unbiased)	130 °C, 85% RH, 96 hours	JESD22-A118
HTSL (High Temperature Storage Life)	150 °C, 1000 hours	JESD22-A103
LTSL (Low Temperature Storage Life)	-40 °C, 1000 hours	JESD22-A119

<sup>1</sup> JEDEC document JEP155 states that 500 V HBM allows safe manufacturing with a standard ESD control process.

<sup>2</sup> JEDEC document JEP157 states that 250 V CDM allows safe manufacturing with a standard ESD control process.

## 4.8 Wi-Fi Radio

Table 24: Wi-Fi Frequency

Parameter	Min (MHz)	Typ (MHz)	Max (MHz)
Center frequency of operating channel	2412	—	2484

### 4.8.1 Wi-Fi RF Transmitter (TX) Specifications

Table 25: TX Power with Spectral Mask and EVM Meeting 802.11 Standards

Rate	Min (dBm)	Typ (dBm)	Max (dBm)
802.11b, 1 Mbps	—	21.0	—
802.11b, 11 Mbps	—	21.0	—
802.11g, 6 Mbps	—	20.5	—
802.11g, 54 Mbps	—	19.0	—
802.11n, HT20, MCS0	—	19.5	—
802.11n, HT20, MCS7	—	18.5	—
802.11n, HT40, MCS0	—	19.5	—
802.11n, HT40, MCS7	—	18.0	—

Table 26: TX EVM Test

Rate	Min (dB)	Typ (dB)	SL <sup>1</sup> (dB)
802.11b, 1 Mbps, @21 dBm	—	-24.5	-10
802.11b, 11 Mbps, @21 dBm	—	-24.5	-10
802.11g, 6 Mbps, @20.5 dBm	—	-21.5	-5
802.11g, 54 Mbps, @19 dBm	—	-28.0	-25
802.11n, HT20, MCS0, @19.5 dBm	—	-23.0	-5
802.11n, HT20, MCS7, @18.5 dBm	—	-29.5	-27
802.11n, HT40, MCS0, @19.5 dBm	—	-23.0	-5
802.11n, HT40, MCS7, @18 dBm	—	-29.5	-27

<sup>1</sup> SL stands for standard limit value.

## 4.8.2 Wi-Fi RF Receiver (RX) Specifications

Table 27: RX Sensitivity

Rate	Min (dBm)	Typ (dBm)	Max (dBm)
802.11b, 1 Mbps	—	-98.4	—
802.11b, 2 Mbps	—	-95.4	—
802.11b, 5.5 Mbps	—	-93.0	—
802.11b, 11 Mbps	—	-88.6	—
802.11g, 6 Mbps	—	-93.2	—
802.11g, 9 Mbps	—	-91.8	—
802.11g, 12 Mbps	—	-91.2	—
802.11g, 18 Mbps	—	-88.6	—
802.11g, 24 Mbps	—	-86.0	—
802.11g, 36 Mbps	—	-82.4	—
802.11g, 48 Mbps	—	-78.2	—
802.11g, 54 Mbps	—	-76.5	—
802.11n, HT20, MCS0	—	-92.6	—
802.11n, HT20, MCS1	—	-91.0	—
802.11n, HT20, MCS2	—	-88.2	—
802.11n, HT20, MCS3	—	-85.0	—
802.11n, HT20, MCS4	—	-81.8	—
802.11n, HT20, MCS5	—	-77.4	—
802.11n, HT20, MCS6	—	-75.8	—
802.11n, HT20, MCS7	—	-74.2	—
802.11n, HT40, MCS0	—	-90.0	—
802.11n, HT40, MCS1	—	-88.0	—
802.11n, HT40, MCS2	—	-85.2	—
802.11n, HT40, MCS3	—	-82.0	—
802.11n, HT40, MCS4	—	-79.0	—

Cont'd on next page



Table 27 – cont'd from previous page

Rate	Min (dBm)	Typ (dBm)	Max (dBm)
802.11n, HT40, MCS5	—	-74.4	—
802.11n, HT40, MCS6	—	-72.8	—
802.11n, HT40, MCS7	—	-71.4	—

Table 28: Maximum RX Level

Rate	Min (dBm)	Typ (dBm)	Max (dBm)
802.11b, 1 Mbps	—	5	—
802.11b, 11 Mbps	—	5	—
802.11g, 6 Mbps	—	5	—
802.11g, 54 Mbps	—	0	—
802.11n, HT20, MCS0	—	5	—
802.11n, HT20, MCS7	—	0	—
802.11n, HT40, MCS0	—	5	—
802.11n, HT40, MCS7	—	0	—

Table 29: RX Adjacent Channel Rejection

Rate	Min (dB)	Typ (dB)	Max (dB)
802.11b, 1 Mbps	—	35	—
802.11b, 11 Mbps	—	35	—
802.11g, 6 Mbps	—	31	—
802.11g, 54 Mbps	—	20	—
802.11n, HT20, MCS0	—	31	—
802.11n, HT20, MCS7	—	16	—
802.11n, HT40, MCS0	—	25	—
802.11n, HT40, MCS7	—	11	—

## 4.9 Bluetooth LE Radio

Table 30: Bluetooth LE Frequency

Parameter	Min (MHz)	Typ (MHz)	Max (MHz)
Center frequency of operating channel	2402	—	2480

### 4.9.1 Bluetooth LE RF Transmitter (TX) Specifications

Table 31: Transmitter Characteristics - Bluetooth LE 1 Mbps

Parameter	Description	Min	Typ	Max	Unit
RF transmit power	RF power control range	-25.00	0	20.00	dBm
	Gain control step	—	3.00	—	dB
Carrier frequency offset and drift	Max $ f_n _{n=0, 1, 2, \dots, k}$	—	2.50	—	kHz
	Max $ f_0 - f_n $	—	2.00	—	kHz
	Max $ f_n - f_{n-5} $	—	1.39	—	kHz
	$ f_1 - f_0 $	—	0.80	—	kHz
Modulation characteristics	$\Delta f_{1avg}$	—	249.00	—	kHz
	Min $\Delta f_{2max}$ (for at least 99.9% of all $\Delta f_{2max}$ )	—	198.00	—	kHz
	$\Delta f_{2avg}/\Delta f_{1avg}$	—	0.86	—	—
In-band spurious emissions	$\pm 2$ MHz offset	—	-37.00	—	dBm
	$\pm 3$ MHz offset	—	-42.00	—	dBm
	$>\pm 3$ MHz offset	—	-44.00	—	dBm

Table 32: Transmitter Characteristics - Bluetooth LE 2 Mbps

Parameter	Description	Min	Typ	Max	Unit
RF transmit power	RF power control range	-25.00	0	20.00	dBm
	Gain control step	—	3.00	—	dB
Carrier frequency offset and drift	Max $ f_n _{n=0, 1, 2, \dots, k}$	—	2.50	—	kHz
	Max $ f_0 - f_n $	—	1.90	—	kHz
	Max $ f_n - f_{n-5} $	—	1.40	—	kHz
	$ f_1 - f_0 $	—	1.10	—	kHz
Modulation characteristics	$\Delta f_{1avg}$	—	499.00	—	kHz
	Min $\Delta f_{2max}$ (for at least 99.9% of all $\Delta f_{2max}$ )	—	416.00	—	kHz
	$\Delta f_{2avg}/\Delta f_{1avg}$	—	0.89	—	—
In-band spurious emissions	$\pm 4$ MHz offset	—	-43.80	—	dBm
	$\pm 5$ MHz offset	—	-45.80	—	dBm
	$>\pm 5$ MHz offset	—	-47.00	—	dBm

Table 33: Transmitter Characteristics - Bluetooth LE 125 Kbps

Parameter	Description	Min	Typ	Max	Unit
RF transmit power	RF power control range	-25.00	0	20.00	dBm
	Gain control step	—	3.00	—	dB
Carrier frequency offset and drift	Max $ f_n _{n=0, 1, 2, \dots, k}$	—	0.80	—	kHz
	Max $ f_0 - f_n $	—	0.98	—	kHz
	$ f_n - f_{n-3} $	—	0.30	—	kHz
	$ f_0 - f_3 $	—	1.00	—	kHz
Modulation characteristics	$\Delta f_{1avg}$	—	248.00	—	kHz

Cont'd on next page

Table 33 – cont'd from previous page

Parameter	Description	Min	Typ	Max	Unit
	Min $\Delta f_{1_{max}}$ (for at least 99.9% of all $\Delta f_{1_{max}}$ )	—	222.00	—	kHz
In-band spurious emissions	$\pm 2$ MHz offset	—	-37.00	—	dBm
	$\pm 3$ MHz offset	—	-42.00	—	dBm
	$> \pm 3$ MHz offset	—	-44.00	—	dBm

Table 34: Transmitter Characteristics - Bluetooth LE 500 Kbps

Parameter	Description	Min	Typ	Max	Unit
RF transmit power	RF power control range	-25.00	0	20.00	dBm
	Gain control step	—	3.00	—	dB
Carrier frequency offset and drift	Max $ f_n _{n=0, 1, 2, \dots, k}$	—	0.70	—	kHz
	Max $ f_0 - f_n $	—	0.90	—	kHz
	$ f_n - f_{n-3} $	—	0.85	—	kHz
	$ f_0 - f_3 $	—	0.34	—	kHz
Modulation characteristics	$\Delta f_{2_{avg}}$	—	213.00	—	kHz
	Min $\Delta f_{2_{max}}$ (for at least 99.9% of all $\Delta f_{2_{max}}$ )	—	196.00	—	kHz
In-band spurious emissions	$\pm 2$ MHz offset	—	-37.00	—	dBm
	$\pm 3$ MHz offset	—	-42.00	—	dBm
	$> \pm 3$ MHz offset	—	-44.00	—	dBm

#### 4.9.2 Bluetooth LE RF Receiver (RX) Specifications

Table 35: Receiver Characteristics - Bluetooth LE 1 Mbps

Parameter	Description	Min	Typ	Max	Unit
Sensitivity @30.8% PER	—	—	-97.5	—	dBm
Maximum received signal @30.8% PER	—	—	8	—	dBm
Co-channel C/I	F = F0 MHz	—	9	—	dB
Adjacent channel selectivity C/I	F = F0 + 1 MHz	—	-3	—	dB
	F = F0 - 1 MHz	—	-3	—	dB
	F = F0 + 2 MHz	—	-28	—	dB
	F = F0 - 2 MHz	—	-30	—	dB
	F = F0 + 3 MHz	—	-31	—	dB
	F = F0 - 3 MHz	—	-33	—	dB
	F > F0 + 3 MHz	—	-32	—	dB
	F > F0 - 3 MHz	—	-36	—	dB
Image frequency	—	—	-32	—	dB
Adjacent channel to image frequency	F = F <sub>image</sub> + 1 MHz	—	-39	—	dB
	F = F <sub>image</sub> - 1 MHz	—	-31	—	dB
Out-of-band blocking performance	30 MHz ~ 2000 MHz	—	-9	—	dBm
	2003 MHz ~ 2399 MHz	—	-19	—	dBm

Cont'd on next page

Table 35 – cont'd from previous page

Parameter	Description	Min	Typ	Max	Unit
	2484 MHz ~ 2997 MHz	—	-16	—	dBm
	3000 MHz ~ 12.75 GHz	—	-5	—	dBm
Intermodulation	—	—	-31	—	dBm

Table 36: Receiver Characteristics - Bluetooth LE 2 Mbps

Parameter	Description	Min	Typ	Max	Unit
Sensitivity @30.8% PER	—	—	-93.5	—	dBm
Maximum received signal @30.8% PER	—	—	3	—	dBm
Co-channel C/I	F = F0 MHz	—	10	—	dB
Adjacent channel selectivity C/I	F = F0 + 2 MHz	—	-8	—	dB
	F = F0 - 2 MHz	—	-5	—	dB
	F = F0 + 4 MHz	—	-31	—	dB
	F = F0 - 4 MHz	—	-33	—	dB
	F = F0 + 6 MHz	—	-37	—	dB
	F = F0 - 6 MHz	—	-37	—	dB
	F > F0 + 6 MHz	—	-40	—	dB
Image frequency	—	—	-31	—	dB
Adjacent channel to image frequency	F = F <sub>image</sub> + 2 MHz	—	-37	—	dB
	F = F <sub>image</sub> - 2 MHz	—	-8	—	dB
Out-of-band blocking performance	30 MHz ~ 2000 MHz	—	-16	—	dBm
	2003 MHz ~ 2399 MHz	—	-20	—	dBm
	2484 MHz ~ 2997 MHz	—	-16	—	dBm
	3000 MHz ~ 12.75 GHz	—	-16	—	dBm
Intermodulation	—	—	-30	—	dBm

Table 37: Receiver Characteristics - Bluetooth LE 125 Kbps

Parameter	Description	Min	Typ	Max	Unit
Sensitivity @30.8% PER	—	—	-104.5	—	dBm
Maximum received signal @30.8% PER	—	—	8	—	dBm
Co-channel C/I	F = F0 MHz	—	6	—	dB
Adjacent channel selectivity C/I	F = F0 + 1 MHz	—	-6	—	dB
	F = F0 - 1 MHz	—	-5	—	dB
	F = F0 + 2 MHz	—	-32	—	dB
	F = F0 - 2 MHz	—	-39	—	dB
	F = F0 + 3 MHz	—	-35	—	dB
	F = F0 - 3 MHz	—	-45	—	dB
	F > F0 + 3 MHz	—	-35	—	dB
Image frequency	—	—	-35	—	dB

Cont'd on next page

Table 37 – cont'd from previous page

Parameter	Description	Min	Typ	Max	Unit
Adjacent channel to image frequency	$F = F_{image} + 1 \text{ MHz}$	—	-49	—	dB
	$F = F_{image} - 1 \text{ MHz}$	—	-32	—	dB

Table 38: Receiver Characteristics - Bluetooth LE 500 Kbps

Parameter	Description	Min	Typ	Max	Unit
Sensitivity @30.8% PER	—	—	-101	—	dBm
Maximum received signal @30.8% PER	—	—	8	—	dBm
Co-channel C/I	$F = F_0 \text{ MHz}$	—	4	—	dB
Adjacent channel selectivity C/I	$F = F_0 + 1 \text{ MHz}$	—	-5	—	dB
	$F = F_0 - 1 \text{ MHz}$	—	-5	—	dB
	$F = F_0 + 2 \text{ MHz}$	—	-28	—	dB
	$F = F_0 - 2 \text{ MHz}$	—	-36	—	dB
	$F = F_0 + 3 \text{ MHz}$	—	-36	—	dB
	$F = F_0 - 3 \text{ MHz}$	—	-38	—	dB
	$F > F_0 + 3 \text{ MHz}$	—	-37	—	dB
	$F > F_0 - 3 \text{ MHz}$	—	-41	—	dB
Image frequency	—	—	-37	—	dB
Adjacent channel to image frequency	$F = F_{image} + 1 \text{ MHz}$	—	-44	—	dB
	$F = F_{image} - 1 \text{ MHz}$	—	-28	—	dB

## 5. Package Information

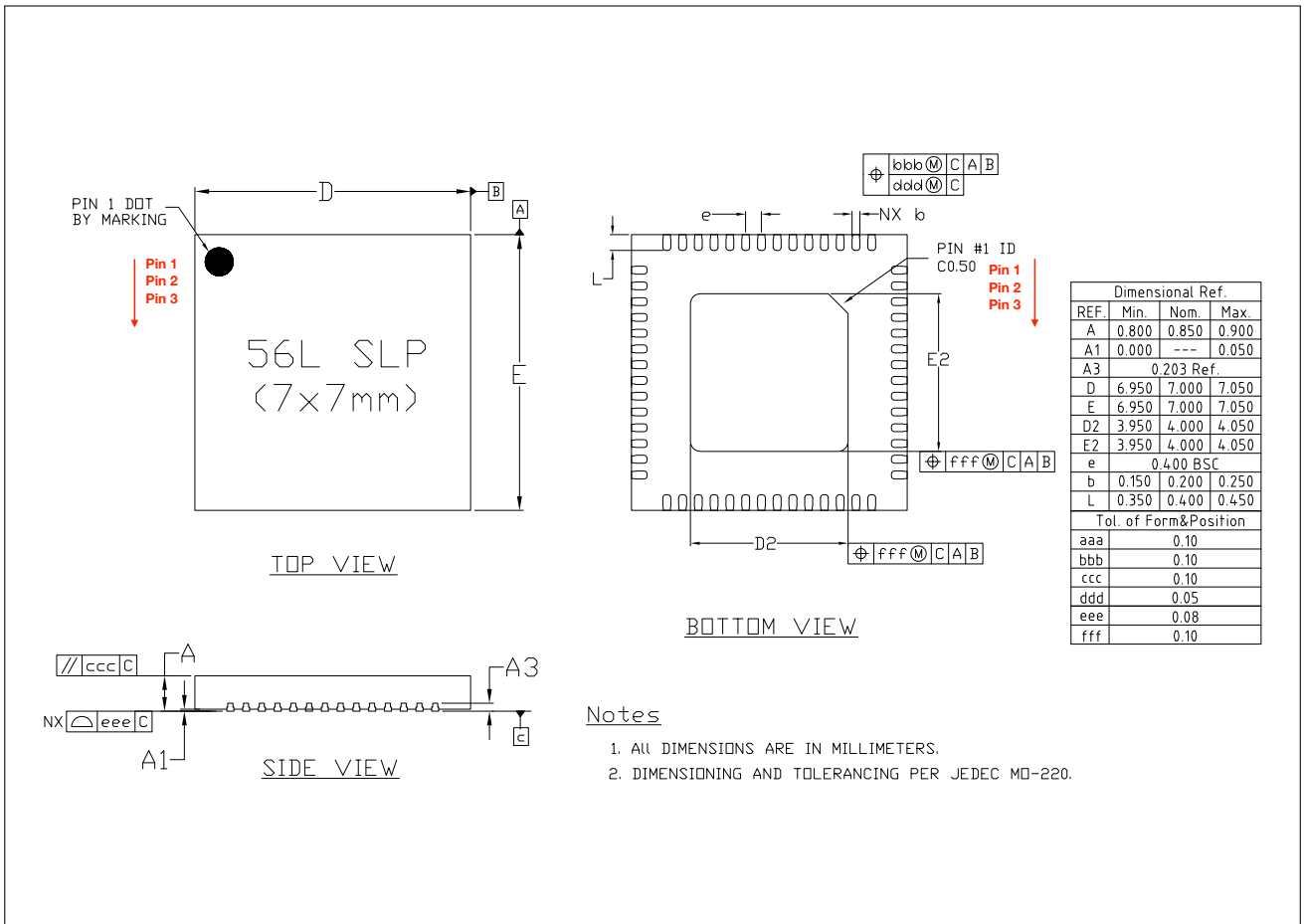

Figure 8: QFN56 (7x7 mm) Package

**Note:**

- The pins of the chip are numbered in an anti-clockwise direction from Pin 1 in the top view.
- For information about tape, reel, and product marking, please refer to [Espressif Chip-Packing Information](#).

## 6. Related Documentation and Resources

### Related Documentation

- [ESP32-S3 Technical Reference Manual](#) – Detailed information on how to use the ESP32-S3 memory and peripherals.
- [ESP32-S3 Hardware Design Guidelines](#) – Guidelines on how to integrate the ESP32-S3 into your hardware product.
- *Certificates*  
<http://espressif.com/en/support/documents/certificates>
- *Documentation Updates and Update Notification Subscription*  
<http://espressif.com/en/support/download/documents>

### Developer Zone

- *ESP-IDF* and other development frameworks on GitHub.  
<http://github.com/espressif>
- *ESP32 BBS Forum* – Engineer-to-Engineer (E2E) Community for Espressif products where you can post questions, share knowledge, explore ideas, and help solve problems with fellow engineers.  
<http://esp32.com/>
- *The ESP Journal* – Best Practices, Articles, and Notes from Espressif folks.  
<http://blog.espressif.com/>
- See the tabs *SDKs and Demos, Apps, Tools, AT Firmware*.  
<http://espressif.com/en/support/download/sdks-demos>

### Products

- *ESP32-S3 Series SoCs* – Browse through all ESP32-S3 SoCs.  
<http://espressif.com/en/products/socs?id=ESP32-S3>
- *ESP32-S3 Series Modules* – Browse through all ESP32-S3-based modules.  
<http://espressif.com/en/products/modules?id=ESP32-S3>
- *ESP32-S3 Series DevKits* – Browse through all ESP32-S3-based devkits.  
<http://espressif.com/en/products/devkits?id=ESP32-S3>
- *ESP Product Selector* – Find an Espressif hardware product suitable for your needs by comparing or applying filters.  
<http://products.espressif.com/#/product-selector?language=en>

### Contact Us

- See the tabs *Sales Questions, Technical Enquiries, Circuit Schematic & PCB Design Review, Get Samples (Online stores), Become Our Supplier, Comments & Suggestions*.  
<http://espressif.com/en/contact-us/sales-questions>

## Revision History

Date	Version	Release Notes
2022-04	v1.1	<ul style="list-style-type: none"> <li>• Synchronized eFuse size throughout</li> <li>• Updated pin description in <a href="#">Table 2</a></li> <li>• Updated SPI resistance in <a href="#">Table 16</a></li> <li>• Added information about chip ESP32-S3FH4R2</li> </ul>
2022-01	v1.0	<ul style="list-style-type: none"> <li>• Added wake-up sources for Deep-sleep mode</li> <li>• Added <a href="#">Table 10</a> for default configurations of VDD_SPI</li> <li>• Added ADC calibration results in <a href="#">Table 19</a></li> <li>• Added typical values when all peripherals and peripheral clocks are enabled to <a href="#">Table 22</a></li> <li>• Added more descriptions of modules/peripherals in <a href="#">Section 3</a></li> <li>• Updated <a href="#">Figure 1</a></li> <li>• Updated JEDEC specification</li> <li>• Updated Wi-Fi RF data in <a href="#">Section 4.6</a></li> <li>• Updated temperature for ESP32-S3R8 and ESP32-S3R8V</li> <li>• Updated description of Deep-sleep mode in <a href="#">Table 21</a></li> <li>• Updated wording throughout</li> </ul>
2021-10-12	v0.6.1	Updated text description
2021-09-30	v0.6	<ul style="list-style-type: none"> <li>• Updated to chip revision 1 by swapping pin 53 and pin 54 (XTAL_P and XTAL_N)</li> <li>• Updated <a href="#">Figure 1</a></li> <li>• Added CoreMark score in section Features</li> <li>• Updated <a href="#">Section 2.8</a></li> <li>• Added data for cumulative IO output current in <a href="#">Table 14</a></li> <li>• Added data for Modem-sleep current consumption in <a href="#">Table 22</a></li> <li>• Updated data in <a href="#">section 4.6, 4.8, and 4.9</a></li> <li>• Updated wording throughout</li> </ul>
2021-07-19	v0.5.1	<ul style="list-style-type: none"> <li>• Added "for chip revision 0" on cover, in footer and watermark to indicate that the current and previous versions of this datasheet are for chip version 0</li> <li>• Corrected a few typos</li> </ul>
2021-07-09	v0.5	Preliminary version





[www.espressif.com](http://www.espressif.com)

## Disclaimer and Copyright Notice

Information in this document, including URL references, is subject to change without notice.

ALL THIRD PARTY'S INFORMATION IN THIS DOCUMENT IS PROVIDED AS IS WITH NO WARRANTIES TO ITS AUTHENTICITY AND ACCURACY.

NO WARRANTY IS PROVIDED TO THIS DOCUMENT FOR ITS MERCHANTABILITY, NON-INFRINGEMENT, FITNESS FOR ANY PARTICULAR PURPOSE, NOR DOES ANY WARRANTY OTHERWISE ARISING OUT OF ANY PROPOSAL, SPECIFICATION OR SAMPLE.

All liability, including liability for infringement of any proprietary rights, relating to use of information in this document is disclaimed. No licenses express or implied, by estoppel or otherwise, to any intellectual property rights are granted herein.

The Wi-Fi Alliance Member logo is a trademark of the Wi-Fi Alliance. The Bluetooth logo is a registered trademark of Bluetooth SIG.

All trade names, trademarks and registered trademarks mentioned in this document are property of their respective owners, and are hereby acknowledged.

**Copyright © 2022 Espressif Systems (Shanghai) Co., Ltd. All rights reserved.**