

PE42546

Document Category: Product Specification

UltraCMOS® SP4T RF Switch, 9 kHz–52 GHz



Features

- Wideband support up to 52 GHz
- Low insertion loss of 2.9 dB @ 45 GHz
- Fast switching time of 60 ns
- High input P1dB of 35 dBm
- High port-to-port isolation of 41 dB
- -40 °C to +105 °C operating temperature support
- Package: 20-lead 3×3 mm LGA

Applications

- Test and measurement (T&M)
- 5G mmWave
- Microwave backhaul
- Radar
- Satellite communications

Figure 1 ■ PE42546 Functional Diagram

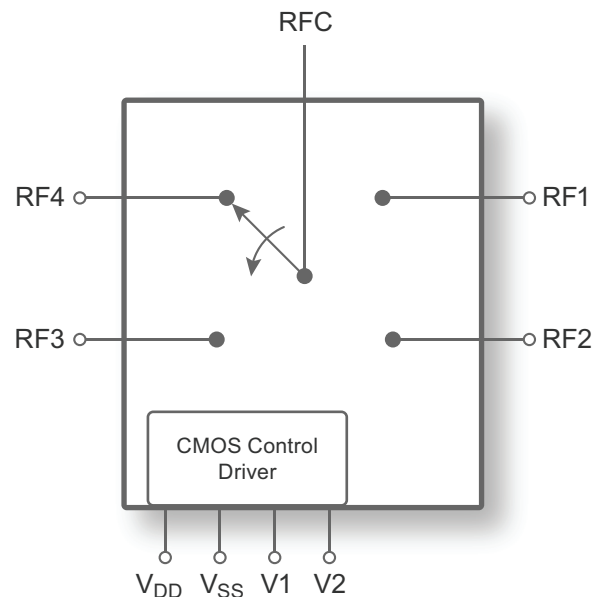

Product Description

The PE42546 is a HaRP™ technology-enhanced reflective SP4T RF switch die that supports a wide frequency range from 9 kHz to 52 GHz. It delivers low insertion loss, fast switching time and high isolation performance, making this device ideal for test and measurement (T&M), 5G mmWave, microwave backhaul, radar and satellite communication applications. No blocking capacitors are required if DC voltage is not present on the RF ports.

The PE42546 is manufactured on pSemi's UltraCMOS® process, a patented variation of silicon-on-insulator (SOI) technology.

Revision History

Table 1 ■ Revision History

Document Revision	Date	Change Description
DOC-101540-5	March 2024	Figure 17, PE42546 Evaluation Board Schematic Table 5, PE42546 Evaluation Board BOM Components
DOC-101540-6	April 2024	Figure 21, Tape and Reel Specification

Absolute Maximum Ratings

Exceeding absolute maximum ratings listed in **Table 2** may cause permanent damage. Operation should be restricted to the limits in **Table 3**. Operation between operating range and absolute maximum for extended periods may reduce reliability.

ESD Precautions

When handling this UltraCMOS device, observe the same precautions as with any other ESD-sensitive devices. Although this device contains circuitry to protect it from damage due to ESD, precautions should be taken to avoid exceeding the rating specified in **Table 2**.

Latch-up Immunity

Unlike conventional CMOS devices, UltraCMOS devices are immune to latch-up.

Table 2 ■ Absolute Maximum Ratings for PE42546

Parameter/Condition	Min	Max	Unit
V _{DD} Positive Supply Voltage	-0.3	3.6	V
V _{SS} Negative Supply Voltage	-3.6	0.3	V
Digital Input Voltage	-0.3	V _{DD} +0.3	V
Storage Temperature	-65	150	°C
ESD voltage HBM, All Pins Except RF ⁽¹⁾	2000		V
ESD voltage HBM, RF Pins ⁽¹⁾	600		V
ESD voltages, CDM, All Pins ⁽²⁾	1000		V
Notes: 1) Human body model (MIL-STD 883 Method 3015). 2) Charged device model (JEDEC JESD22-C101).			

Recommended Operating Conditions

Table 3 lists the recommended operating conditions for the PE42546. Devices should not be operated outside the operating conditions listed below.

Table 3 ■ Recommended Operating Conditions for PE42546

Parameter	Min	Typ	Max	Unit
VDD Positive Supply Voltage	3.15	3.3	3.45	V
VSS Negative Supply Voltage	-3.45	-3.3	-3.15	V
IDD Positive Supply Current		3		μA
ISS Negative Supply Current		-110		μA
Control Voltage High	1.2		3.3	V
Control Voltage Low	0		0.8	V
Digital Input Leakage Current			35	μA
RF Input Power, CW (RFC-RFX)			Fig. 2	dBm
RF Input Power, Pulsed (RFC-RFX)			Fig. 2	dBm
Temperature Range	-40	25	105	°C

Electrical Specifications

Table 4 provides the PE42546 key electrical specifications @ +25 °C, $V_{DD} = 3.3V$, $V_{SS} = -3.3V$ unless otherwise specified.

Table 4 ■ *Electrical Specifications for PE42546*

Parameter	Description	Frequency (MHz)	Min	Typ	Max	Unit
Insertion Loss		10		1.1	1.3	dB
		10 to 18000		2.0	2.5	dB
		18000 to 35000		2.3	3.0	dB
		35000 to 40000		2.5	3.4	dB
		40000 to 45000		2.9	4.2	dB
		45000 to 52000		3.7	4.8	dB
Isolation	RFC to RFX	10 to 18000	39	41		dB
		18000 to 35000	31	35		dB
		35000 to 40000	31	35		dB
		40000 to 45000	27	32		dB
		45000 to 52000	23	23		dB
	RFX to RFX	10 to 18000	35	37		dB
		18000 to 35000	31	33		dB
		35000 to 40000	29	32		dB
		40000 to 45000	26	30		dB
		45000 to 52000	24	27		dB
Return Loss (Common Port)		10 to 8000		13		dB
		8000 to 30000		13		dB
		30000 to 35000		12		dB
		35000 to 45000		12		dB
		45000 to 52000		12		dB
Return Loss (Active Port)		10 to 35000		12		dB
		35000 to 45000		12		dB
		45000 to 52000		11		dB
0.1dB Compression ^(*)		14 GHz		27		dBm
1 dB Compression ^(*)		14 GHz		35		dBm

Table 4 ■ Electrical Specifications for PE42546

Parameter	Description	Frequency (MHz)	Min	Typ	Max	Unit
Input IP2		100		103		dBm
		746		105		dBm
		1974		110		dBm
		2635		111		dBm
Input IP3		746		52		dBm
		1974		53		dBm
		2635		53		dBm
		24900		52		dBm
		40200		52		dBm
		47900		52		dBm
Switching Time	50% VCTL to 10% to 90% of RF output			60		nsec

Note: * Pulse 100 μ s duty cycle 10%.

Power De-rating Curve

Figure 2 shows the power de-rating curve for the PE42546 from 10 kHz–52 GHz @ –40°C to +105 °C ambient, (50Ω).

Figure 2 ▪ Power De-rating Curve for PE42546

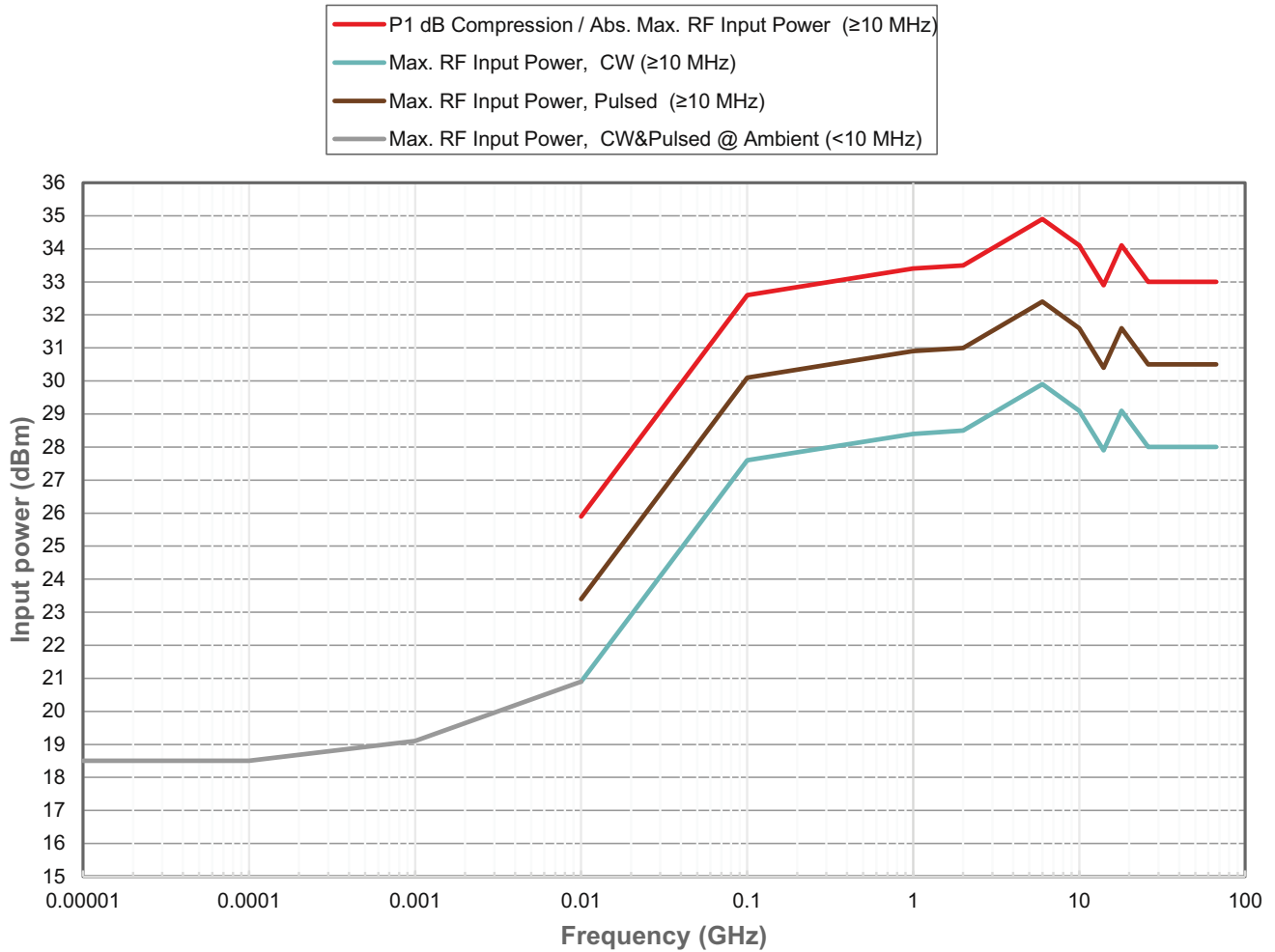

Typical Performance Data

Figure 3–Figure 13 show the typical performance data at +25 °C, $V_{DD} = 3.3V$, $V_{SS} = -3.3V$ ($Z_S = Z_L = 50\Omega$), unless otherwise specified.

Figure 3 ■ Insertion Loss RFC to RFX vs. Frequency

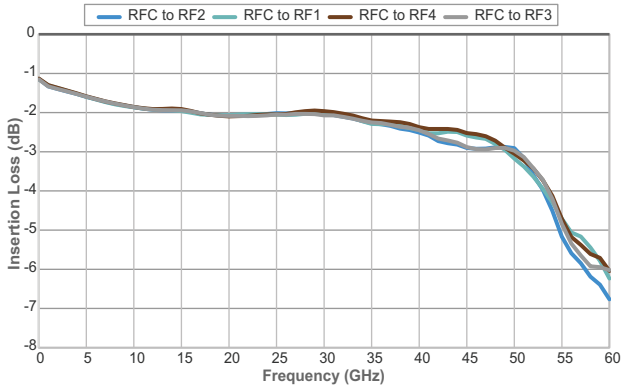

Figure 4 ■ Insertion Loss vs. Temperature (RFC–RF1)

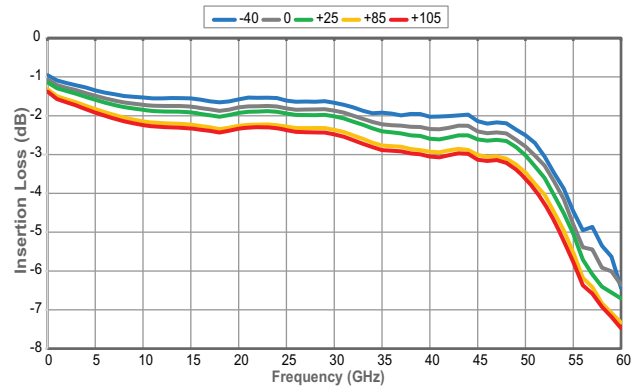

Figure 5 ■ Insertion Loss vs. Temperature (RFC–RF2)

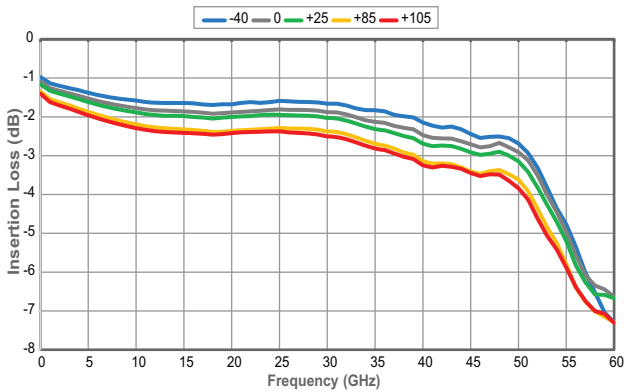

Figure 6 ■ Isolation (RFC–RFX)

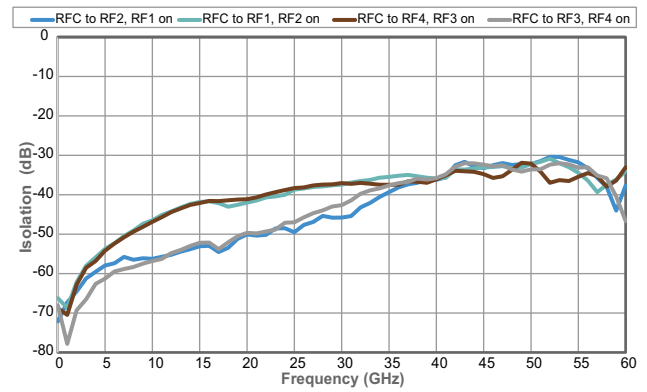

Figure 7 ■ Isolation (RFX–RFX)

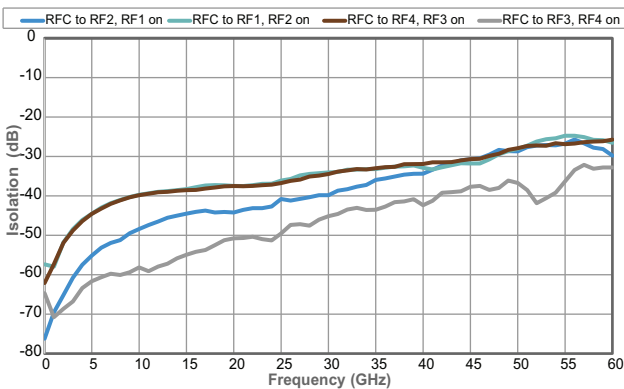

Figure 8 ■ Isolation vs. Temperature (RF1–RF2, RF1 On)

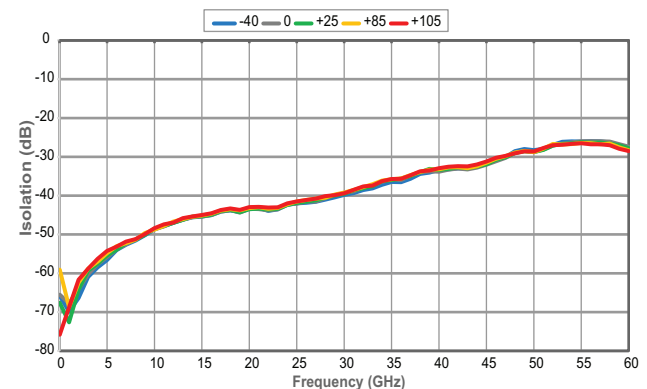

Figure 9 ■ Isolation vs. Temperature (RF1–RF2, RF2 On)

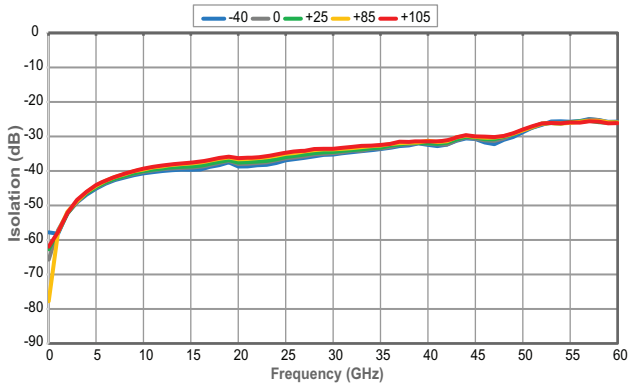

Figure 10 ■ Isolation vs. Temperature (RFC–RF1, RF2 On)

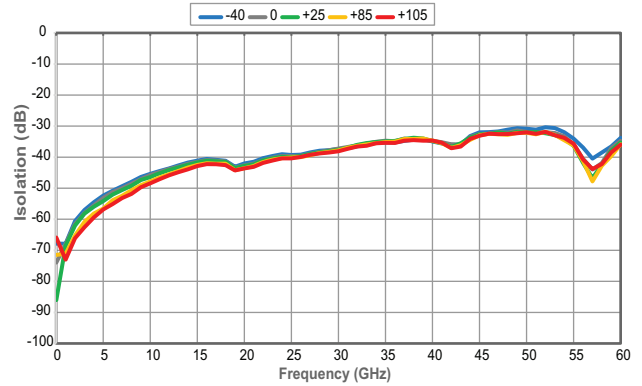

Figure 11 ■ Isolation vs. Temperature (RFC–RF2, RF1 On)

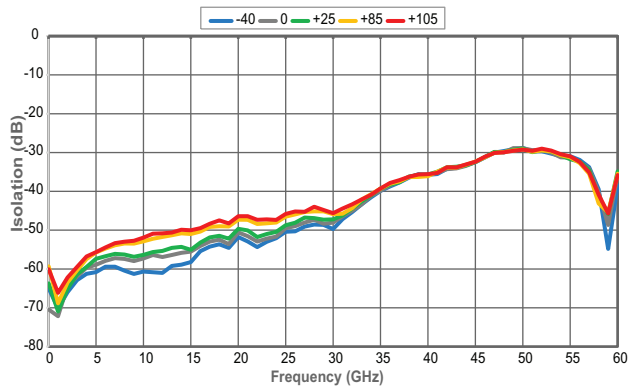

Figure 12 ■ Return Loss Active Port (RFX On)

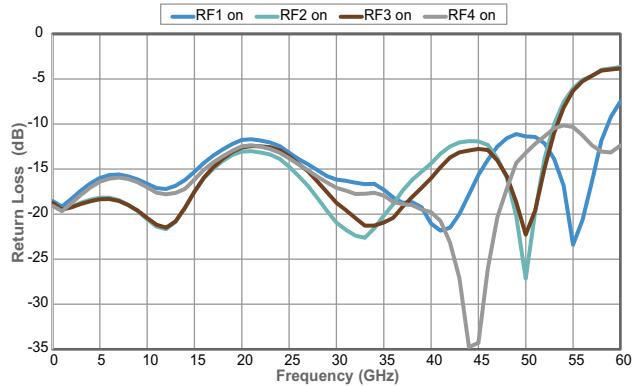
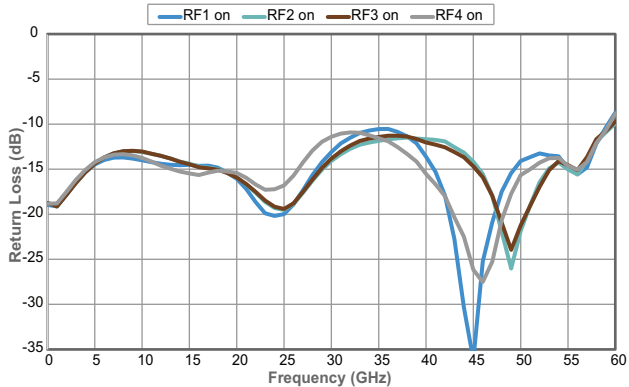

Figure 13 ■ Return Loss Common Port (RFX On)



Evaluation Kit

The SP4T switch evaluation kit board was designed to ease customer evaluation of pSemi's PE42546. The RF common port is connected through a 50Ω transmission line via the top SMA connector, J6. RF1, RF2, RF3 and RF4 are connected through 50Ω transmission lines via SMA connectors J1, J3, J5 and J4, respectively. A through 50Ω transmission is available via SMA connectors J7 and J8. This transmission line can be used to estimate the loss of the PCB over the environmental conditions being evaluated.

The board is constructed of a four-metal-layer material with a total thickness of 62 mils. The dual-clad top RF layer is Astra MT77 material with a 2.5 mil prepreg and $\epsilon_r = 3.00$. The middle layers provide ground for the transmission lines. The transmission lines were designed using a coplanar waveguide with ground plane model using a trace width of 4.75 mils, trace gaps of 4 mils, and metal with 2 mil thickness.

Figure 14 ■ Evaluation Board Layout, Assembly Primary and Secondary Sides for PE42546

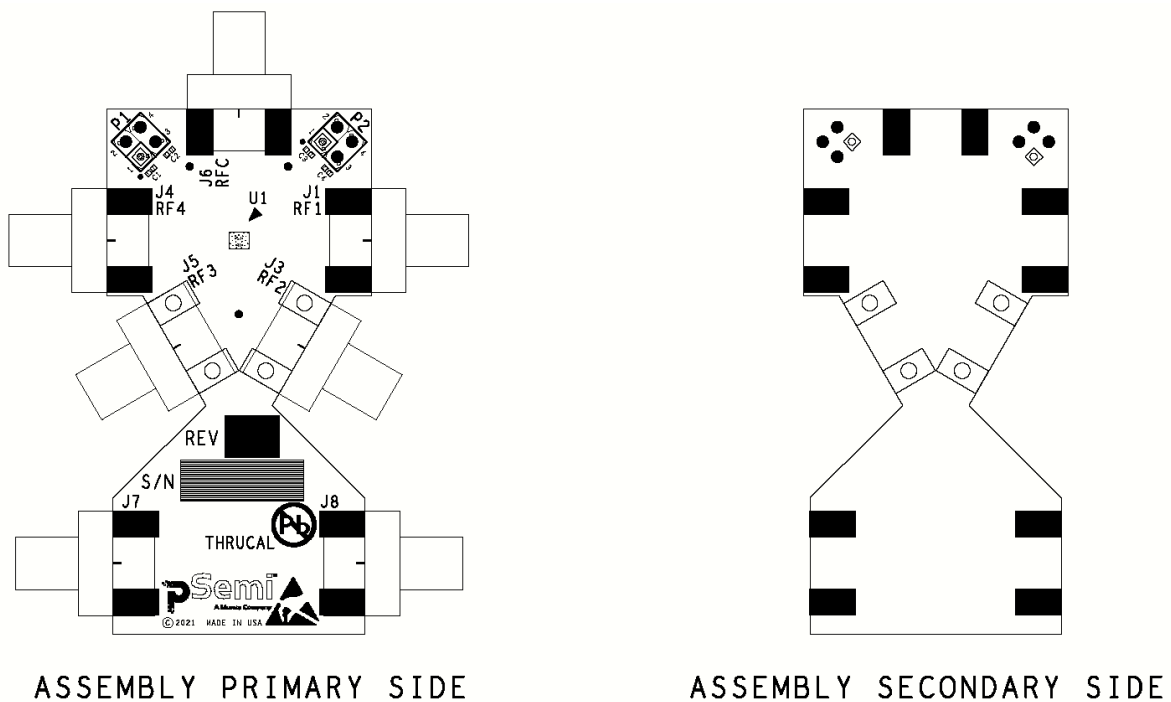

Figure 15 ■ Evaluation Board Layout, Top Layer for PE42546

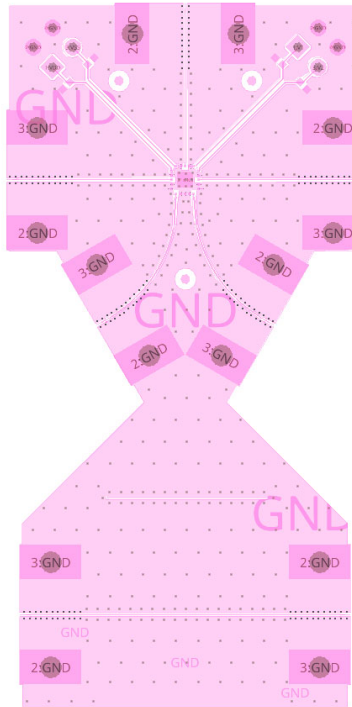
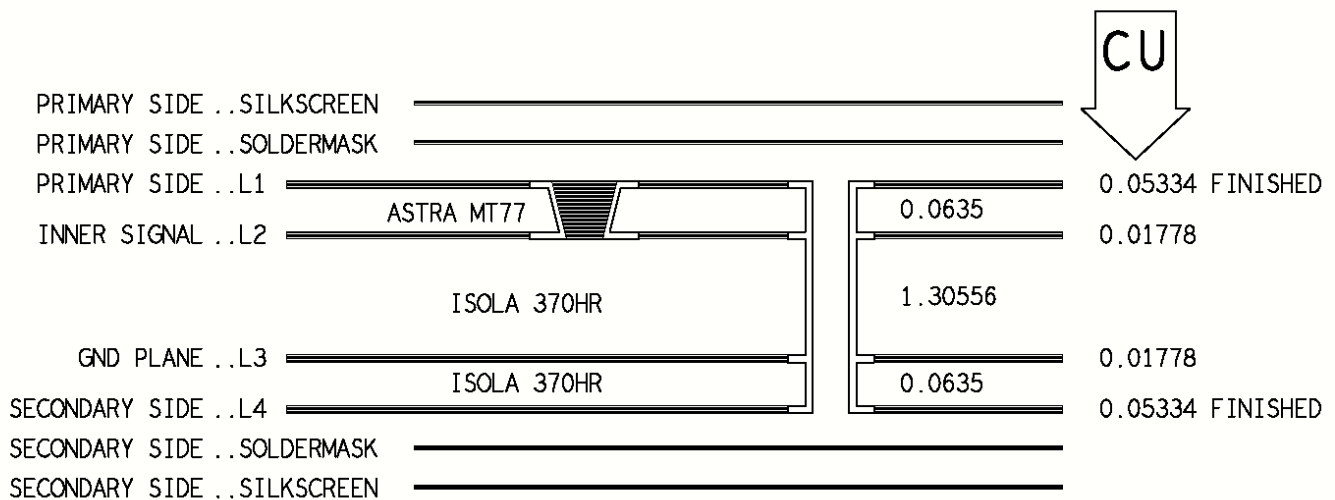

Figure 16 ■ Evaluation Board Layout, Stack Up for PE42546

4 LAYER - STACK UP



TOTAL BOARD THICKNESS: 1.5748 ± 0.127
UNITS: Metric

Evaluation Board Schematic and BOM

Figure 17 shows the evaluation board schematic. Table 5 shows the evaluation board bill of materials.

Figure 17 ▪ PE42546 Evaluation Board Schematic

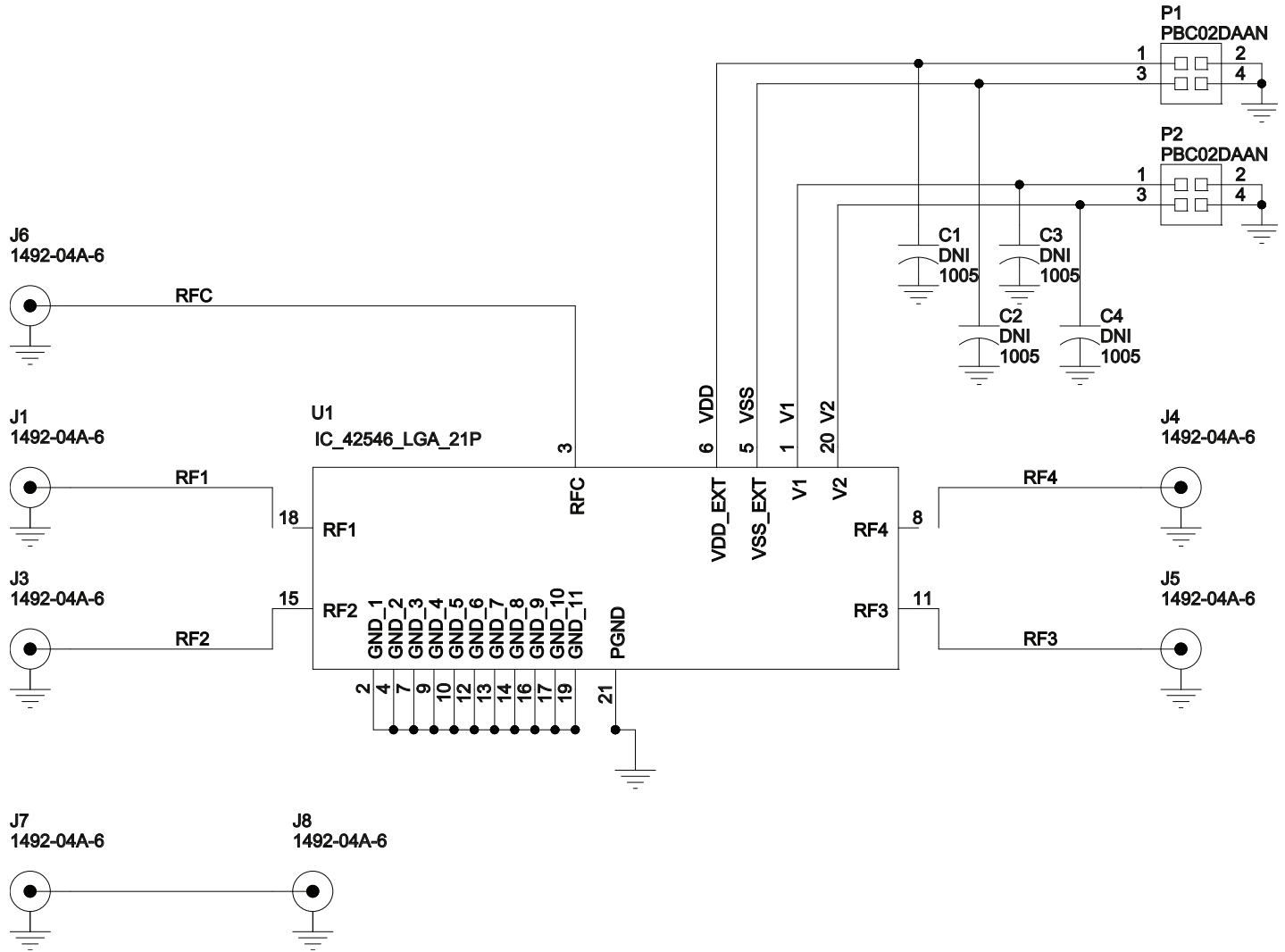

Table 5 ■ PE42546 Evaluation Board BOM Components

Reference	Value	Description	Manufacturer	Mfg. Part Number
C1,C2,C3,C4	DNI	CAP, SMD, CER, DNI, n/a, n/a, n/a, 0402 (1005 Metric)		
J1,J3,J4,J5,J6,J7,J8	CN_1492-04A-6	CONN, Coaxial Connectors (RF), SMA, SMD, Jack, Female Socket, 50GHz	Southwest Microwave	1492-04A-6
P1,P2	PBC02DAAN	CONN, Rectangular Connectors - Headers, Male Pins, Header Unshrouded Breakaway, TH, Male, 2.54mmX2.54mm, 4 POS	Sullins Connector Solutions	PBC02DAAN
U1	IC_42546_L-GA_21P	IC, 42546 LGA	pSemi Corporation	

Pin Information

This section provides pinout information for the PE42546. **Figure 18** shows the pin map of this device for the available package. **Table 6** provides a description for each pin.

Figure 18 ▪ Pin Configuration (Top View)

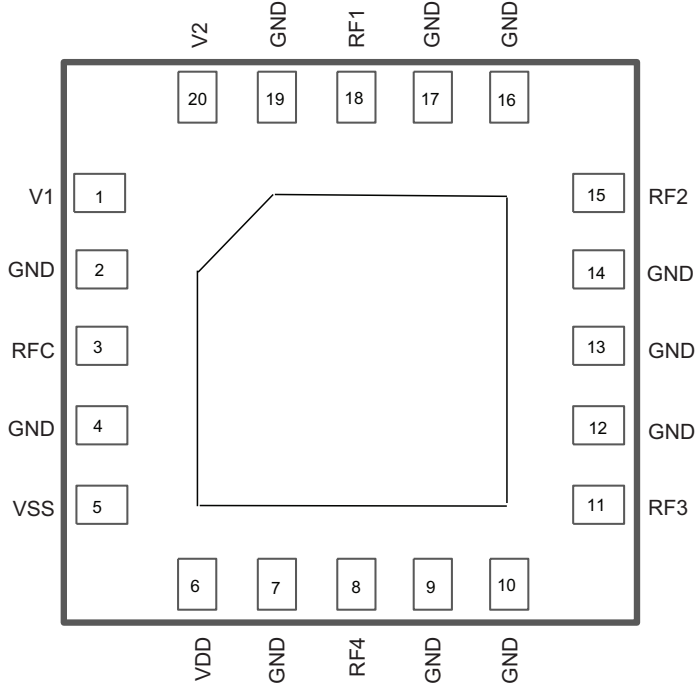

Table 6 ▪ Pin Descriptions for PE42546

Pin No.	Pin Name	Description
1	V1	Control input 1
2	GND	Ground
3	RFC	RF common port
4	GND	Ground
5	VSS	Negative supply voltage
6	VDD	Positive supply voltage
7	GND	Ground
8	RF4	RF throw port 4
9	GND	Ground
10	GND	Ground
11	RF3	RF throw port 3
12	GND	Ground
13	GND	Ground
14	GND	Ground
15	RF2	RF throw port 2
16	GND	Ground
17	GND	Ground
18	RF1	RF throw port 1
19	GND	Ground
20	V2	Control input 2

Control Logic

Table 7 provides the control logic truth table for the PE42546, where 0 = Low (0–0.8V) and 1 = High (1.2–3.3V).

Table 7 ▪ Truth Table for PE42546

V1	V2	RF1	RF2	RF3	RF4
0	0	ON	Isolation	Isolation	Isolation
1	0	Isolation	ON	Isolation	Isolation
0	1	Isolation	Isolation	ON	Isolation
1	1	Isolation	Isolation	Isolation	ON

Packaging Information

This section provides packaging data including the moisture sensitivity level, package drawing, package marking and tape-and-reel information.

Moisture Sensitivity Level

The moisture sensitivity level rating for the PE42546 in the 20-lead 3×3 mm LGA package is MSL 3.

Package Drawing

Figure 19 ■ Package Mechanical Drawing for 20-lead 3×3 mm LGA

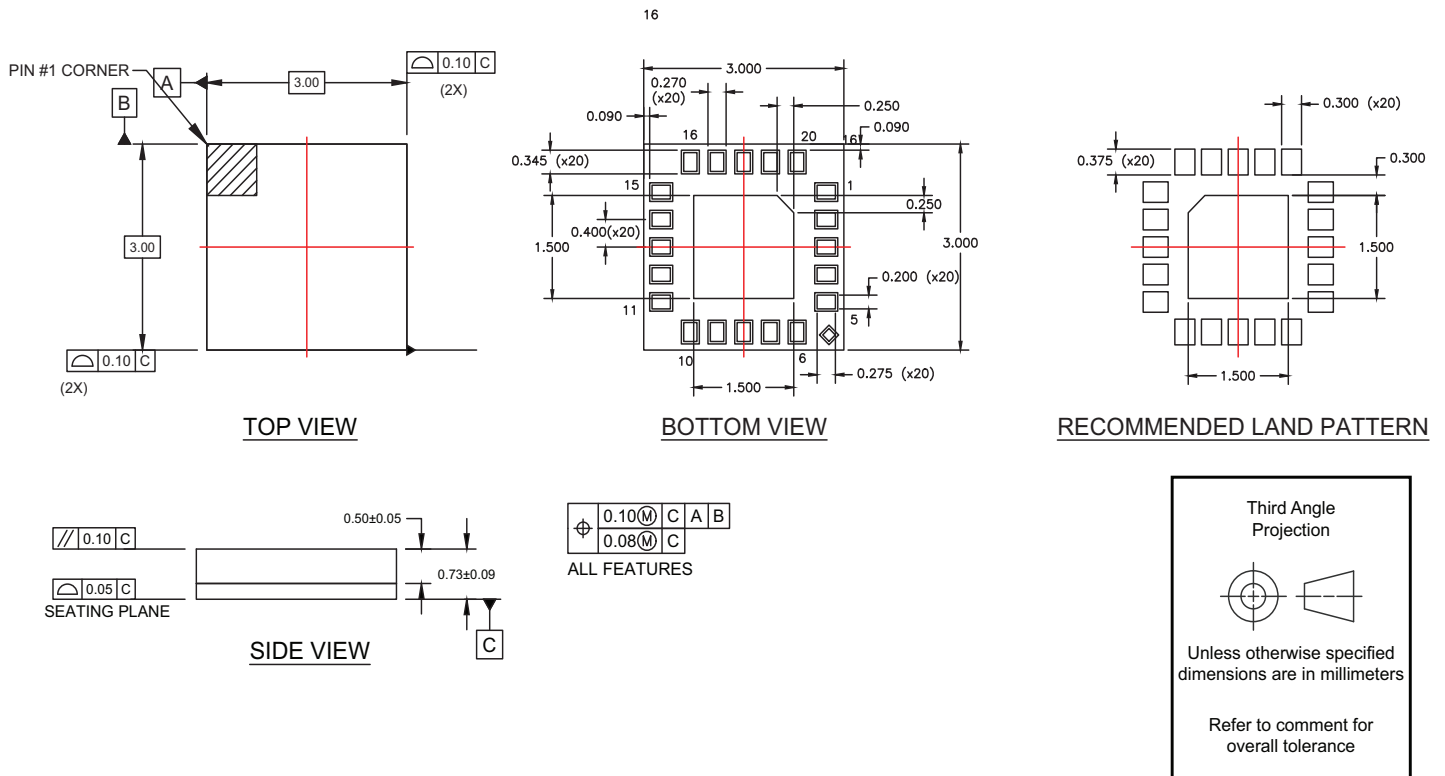

Third Angle Projection

Unless otherwise specified dimensions are in millimeters

Refer to comment for overall tolerance

Top-Marking Specification

Figure 20 ▪ Package Marking Specifications for PE42546

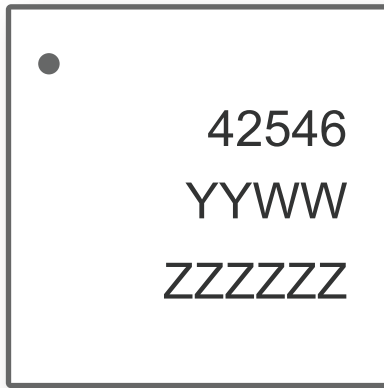

- = Pin 1 indicator
- 42546 = Product part number
- YY = Last two digits of assembly year (2022 = 22)
- WW = Work week of assembly lot start date (01, ..., 52)
- ZZZZZZ = Assembly lot code (max six characters)

DOC-101587-1

Tape and Reel Specification

This section provides the tape and reel specifications for the PE42546.

Figure 21 ▪ Tape and Reel Specifications for PE42546

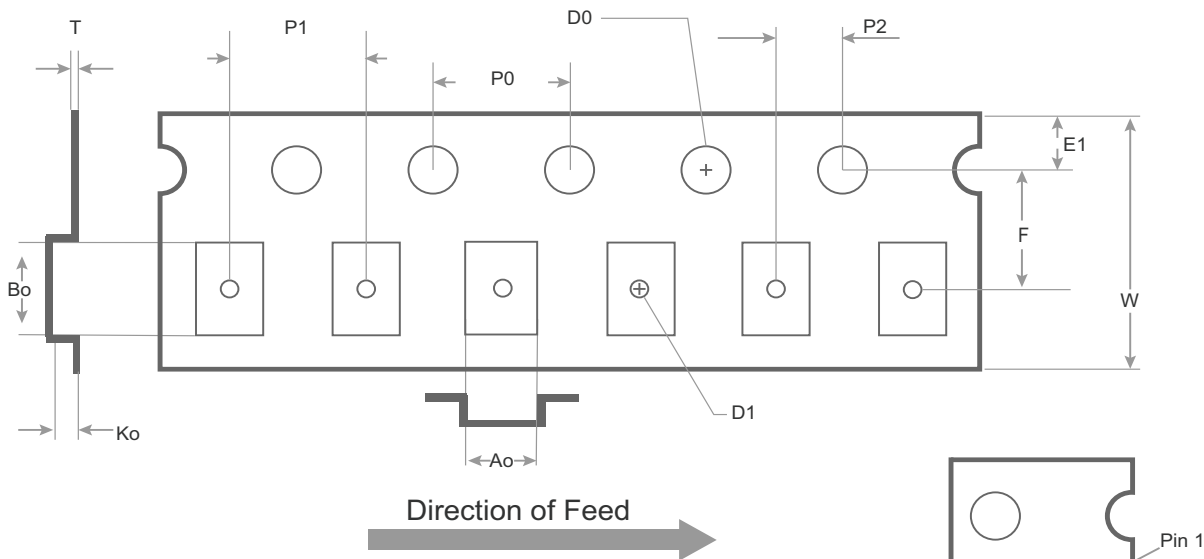

Notes:
Not drawn to scale.
Dimensions are in millimeters.
Maximum cavity angle 5 degrees.
Bumped die are oriented active side down.

Carrier Tape Dimension Table					
Pocket	Nominal	Tolerance	Pocket	Nominal	Tolerance
Ao	3.30	+/- 0.1	D1	1.5	Min.
Bo	3.30	+/- 0.1	D0	1.55	+/- 0.05
Ko	1.10	+/- 0.1	E1	1.75	+/- 0.1
P1	8.00	+/- 0.1	P0	4.0	+/- 0.1
W	12.00	+0.3 / -0.3	P2	2.0	+/- 0.05
F	5.5	+/- 0.05	T	0.2	+/- 0.05

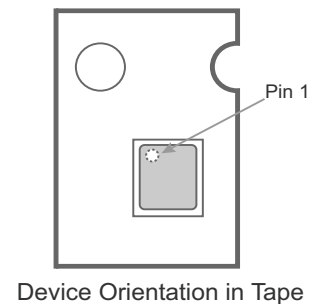

DOC-101540

Ordering Information

Table 8 lists the available ordering codes for the PE42546 as well as available shipping methods.

Table 8 ■ Order Codes for PE42546

Order Codes	Description	Packaging	Shipping Method
PE42546A-X	PE42546 SP4T RF Switch	20-lead 3×3 mm LGA	500 die/T&R
PE42546A-Z	PE42546 SP4T RF Switch	20-lead 3×3 mm LGA	3000 die/T&R
EK42546-88	PE42546 SP4T RF Switch Connectorized EVK	Evaluation Kit	1/Box

Document Categories

Advance Information

The product is in a formative or design stage. The datasheet contains design target specifications for product development. Specifications and features may change in any manner without notice.

Preliminary Specification

The datasheet contains preliminary data. Additional data may be added at a later date. pSemi reserves the right to change specifications at any time without notice in order to supply the best possible product.

Product Specification

The datasheet contains final data. In the event pSemi decides to change the specifications, pSemi will notify customers of the intended changes by issuing a CNF (Customer Notification Form).

Sales Contact

For additional information, contact Sales at sales@psemi.com.

Disclaimers

The information in this document is believed to be reliable. However, pSemi assumes no liability for the use of this information. Use shall be entirely at the user's own risk. No patent rights or licenses to any circuits described in this document are implied or granted to any third party. pSemi's products are not designed or intended for use in devices or systems intended for surgical implant, or in other applications intended to support or sustain life, or in any application in which the failure of the pSemi product could create a situation in which personal injury or death might occur. pSemi assumes no liability for damages, including consequential or incidental damages, arising out of the use of its products in such applications.

Patent Statement

pSemi products are protected under one or more of the following U.S. patents: patents.psemi.com

Copyright and Trademark

©2021-2024, pSemi Corporation. All rights reserved. The Peregrine Semiconductor name, Peregrine Semiconductor logo and UltraCMOS are registered trademarks and the pSemi name, pSemi logo, HaRP and DuNE are trademarks of pSemi Corporation in the U.S. and other countries.