

## Product Overview

1200V, 80 mΩ typical at  $V_{GS} = 20V$ , 90 mΩ typical at  $V_{GS} = 18V$ , Silicon Carbide (SiC) N-Channel MOSFET, TO-247 4-lead with a source sense.

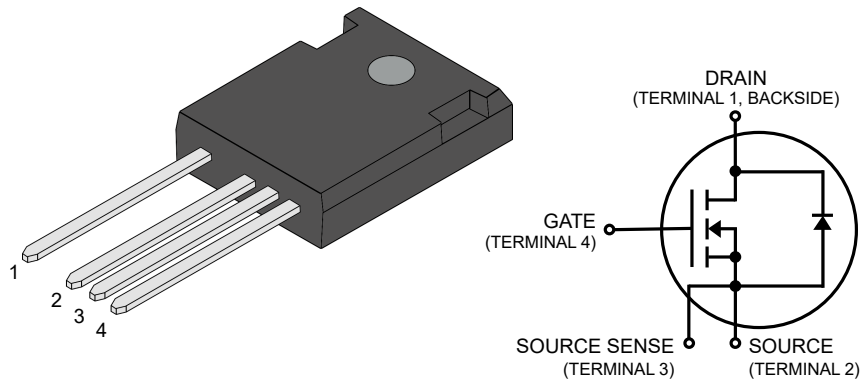

### Features

- Low capacitances and low gate charge
- Fast switching speed due to low internal gate resistance (ESR)
- Stable operation at high junction temperature,  $T_{J(max)} = 175\text{ °C}$
- Fast and reliable body diode
- Superior avalanche ruggedness
- RoHS compliant

### Benefits

- High efficiency to enable lighter and more compact system
- Simple to drive and easy to parallel
- Improved thermal capabilities and lower switching losses
- Eliminates the need for external freewheeling diode
- Lower system cost of ownership

### Applications

- Photovoltaic (PV) inverter, converter, and industrial motor drives
- Smart grid transmission and distribution
- Induction heating and welding
- Hybrid Electric Vehicle (HEV) powertrain and Electric Vehicle (EV) charger
- Power supply and distribution

## 1. Device Specifications

This section shows the specifications of this device.

### 1.1 Absolute Maximum Ratings

The following table shows the absolute maximum ratings of this device.

**Table 1-1.** Absolute Maximum Ratings

Symbol	Parameter	Ratings	Unit
$V_{DSS}$	Drain source voltage	1200	V
$I_D$	Continuous drain current at $T_C = 25\text{ }^\circ\text{C}$	40	A
	Continuous drain current at $T_C = 100\text{ }^\circ\text{C}$	28	
$I_{DM}$	Pulsed drain current <sup>1</sup>	111	
$V_{GS}$	Gate-source voltage	23 to -10	V
	Transient gate-source voltage	25 to -12	
$P_D$	Total power dissipation at $T_C = 25\text{ }^\circ\text{C}$	231	W
	Linear derating factor	1.5	W/ $^\circ\text{C}$

**Note:**

1. Repetitive rating; pulse width and case temperature are limited by the maximum junction temperature.

The following table shows the thermal and mechanical characteristics of this device.

**Table 1-2.** Thermal and Mechanical Characteristics

Symbol	Characteristic/Test Conditions	Min.	Typ.	Max.	Unit
$R_{\theta JC}$	Junction-to-case thermal resistance	—	0.5	0.65	$^\circ\text{C}/\text{W}$
$T_J$	Operating junction temperature	-55	—	175	$^\circ\text{C}$
$T_{STG}$	Storage temperature	-55	—	150	
$T_L$	Lead temperature for 10 seconds	—	—	300	$^\circ\text{C}$
$\tau_M$	Mounting torque, M3 screw for heat sink attachment (requires 1, not included)	—	0.8	—	N·m
Wt	Package weight	—	6.2	—	g

ESD practices should comply with JESD-625.

### 1.2 Electrical Performance

The following table shows the static characteristics of this device.  $T_J = 25\text{ }^\circ\text{C}$  unless otherwise specified.

**Table 1-3.** Static Characteristics

Symbol	Characteristic	Test Conditions	Min.	Typ.	Max.	Unit
$V_{(BR)DSS}$	Drain-source breakdown voltage	$V_{GS} = 0\text{V}, I_D = 100\text{ }\mu\text{A}$	1200	—	—	V
$R_{DS(on)}$	Drain-source on resistance <sup>1</sup>	$V_{GS} = 20\text{V}, I_D = 15\text{A}$	—	80	100	$\text{m}\Omega$
		$V_{GS} = 18\text{V}, I_D = 15\text{A}$	—	90	—	
$V_{GS(th)}$	Gate-source threshold voltage	$V_{GS} = V_{DS}, I_D = 1\text{ mA}$	1.9	3.0	5.0	V
$I_{DSS}$	Zero gate voltage drain current	$V_{DS} = 1200\text{V}, V_{GS} = 0\text{V}$	—	0.2	30	$\mu\text{A}$
		$V_{DS} = 1200\text{V}, V_{GS} = 0\text{V}, T_J = 175\text{ }^\circ\text{C}$	—	2	—	
$I_{GSS}$	Gate-source leakage current	$V_{GS} = 20\text{V}/-10\text{V}$	—	—	$\pm 100$	nA

**Note:**

1. Pulse test: pulse width < 380  $\mu$ s, duty cycle < 2%.

The following table shows the dynamic characteristics of this device.  $T_J = 25\text{ }^\circ\text{C}$  unless otherwise specified. The dynamic characteristics are characterized, not 100% tested, at the recommended operating  $V_{GS} = 20\text{V}/-5\text{V}$ .

**Table 1-4. Dynamic Characteristics**

Symbol	Characteristic	Test Conditions	Min.	Typ.	Max.	Unit
$C_{iss}$	Input capacitance	$V_{GS} = 0\text{V}$	—	1031	—	pF
$C_{rss}$	Reverse transfer capacitance	$V_{DD} = 1000\text{V}$	—	6	—	
$C_{oss}$	Output capacitance	$V_{AC} = 25\text{ mV}$ $f = 200\text{ kHz}$	—	92	—	
$Q_G$	Total gate charge	$V_{GS} = -5\text{V}/20\text{V}$	—	64	—	nC
$Q_{GS}$	Gate-source charge	$V_{DD} = 800\text{V}$	—	12	—	
$Q_{GD}$	Gate-drain charge	$I_D = 15\text{A}$	—	19	—	
$t_{d(on)}$	Turn-on delay time	$V_{DD} = 850\text{V}$	—	13	—	ns
$t_r$	Voltage rise time	$V_{GS} = -5\text{V}/20\text{V}$	—	10	—	
$t_{d(off)}$	Turn-off delay time	$I_D = 20\text{A}$	—	22	—	
$t_f$	Voltage fall time	$R_{G(ext)} = 8\Omega$	—	12	—	
$E_{on}$	Turn-on switching energy	Freewheeling diode = MSC080SMA120B4 ( $V_{GS} = -5\text{V}$ ); reference <a href="#">Figure 1-19</a>	—	469	—	$\mu$ J
$E_{off}$	Turn-off switching energy		—	51	—	
ESR	Gate equivalent series resistance	$f = 1\text{ MHz}$ , 25 mV, drain short	—	1.9	—	$\Omega$
SCWT	Short circuit withstand time	$V_{DS} = 960\text{V}$ , $V_{GS} = 20\text{V}$	—	3.0	—	$\mu$ s
$E_{AS}$	Avalanche energy, single pulse	$I_D = 15\text{A}$	—	1300	—	mJ

The following table shows the body diode characteristics of this device.  $T_J = 25\text{ }^\circ\text{C}$  unless otherwise specified. The body diode reverse recovery is characterized, not 100% tested.

**Table 1-5. Body Diode Characteristics**

Symbol	Characteristic	Test Conditions	Min.	Typ.	Max.	Unit
$V_{SD}$	Diode forward voltage	$I_{SD} = 15\text{A}$ , $V_{GS} = 0\text{V}$	—	3.7	—	V
		$I_{SD} = 15\text{A}$ , $V_{GS} = -5\text{V}$	—	3.9	5.0	
$t_{rr}$	Reverse recovery time	$I_{SD} = 20\text{A}$ , $V_{GS} = -5\text{V}$ , Drive $R_G = 8\Omega$ , $V_{DD} = 850\text{V}$ , $dI/dt = -10100\text{ A}/\mu\text{s}$	—	12	—	ns
$Q_{rr}$	Reverse recovery charge		—	416	—	nC
$I_{RRM}$	Reverse recovery current		—	59	—	A

### 1.3 Typical Performance Curves

Data for performance curves are characterized, not 100% tested.

**Figure 1-1.** Drain Current vs.  $V_{DS}$  at  $T_J$

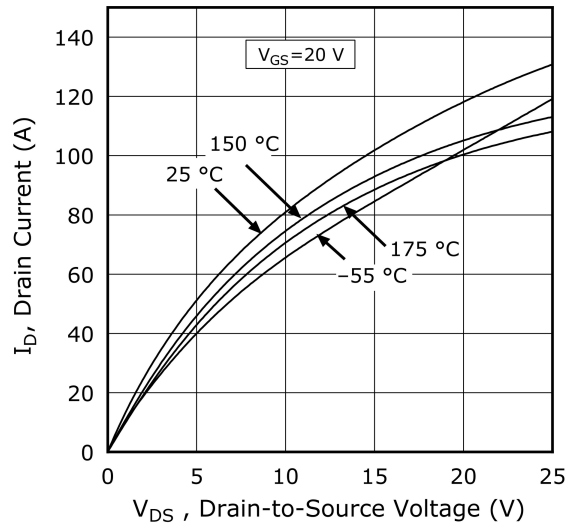

**Figure 1-2.** Drain Current vs.  $V_{DS}$  at  $V_{GS}$

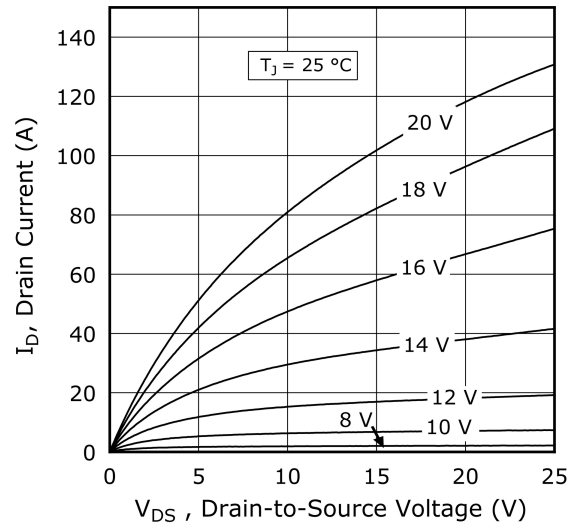

**Figure 1-3.** Drain Current vs.  $V_{DS}$  at  $V_{GS}$

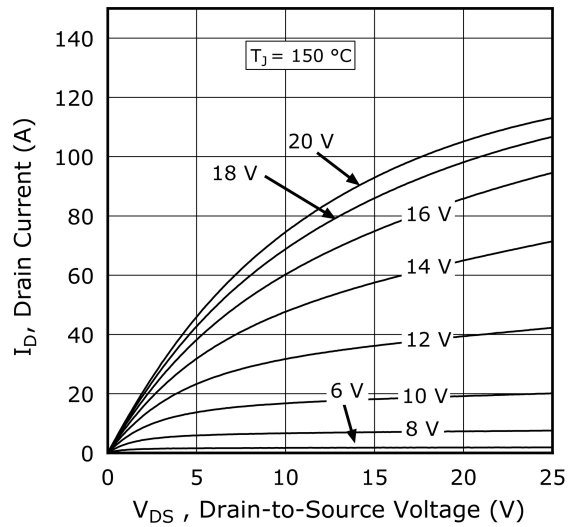

**Figure 1-4.** Drain Current vs.  $V_{DS}$  at  $V_{GS}$

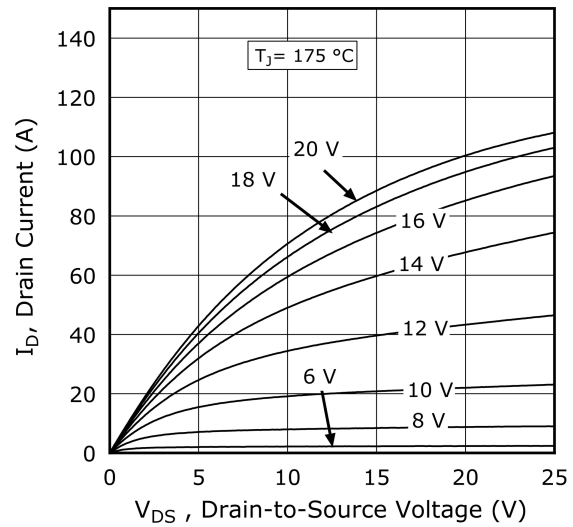

**Figure 1-5.**  $R_{DS(on)}$  vs. Junction Temperature

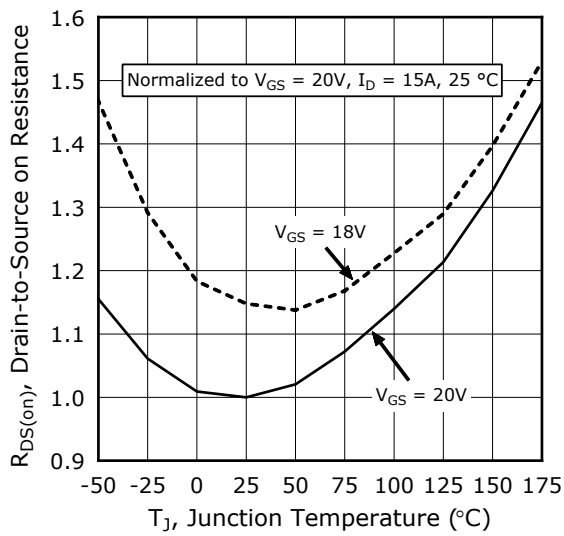

**Figure 1-6.** Gate Charge Characteristics

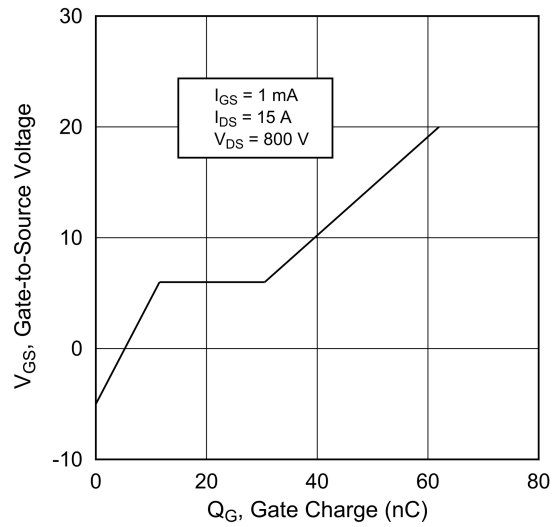

**Figure 1-7.** Capacitance vs. Drain-to-Source Voltage

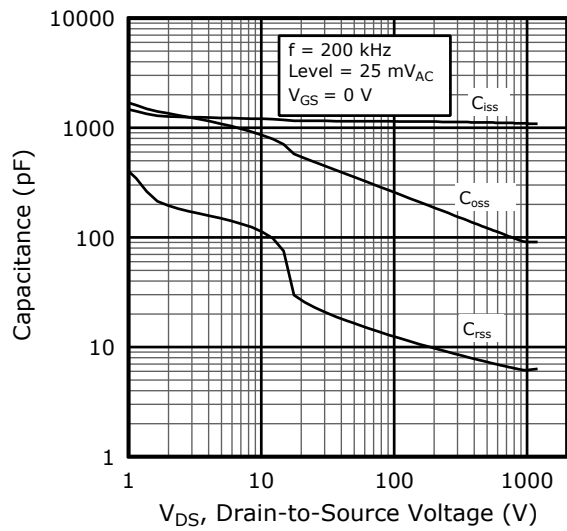

**Figure 1-8.** Output Charge vs. Drain-to-Source Voltage

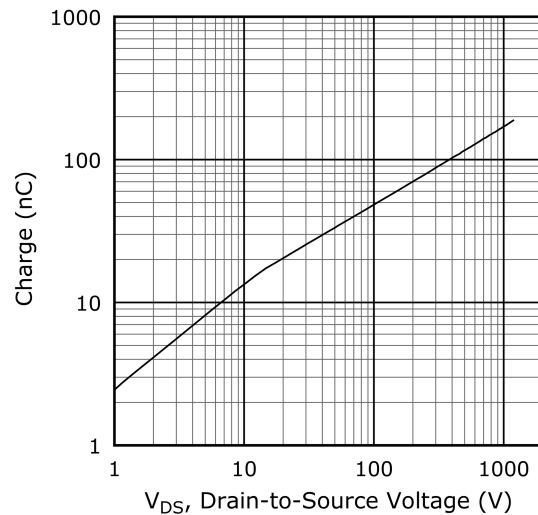

Figure 1-9. Output Stored Energy vs.  $V_{DS}$

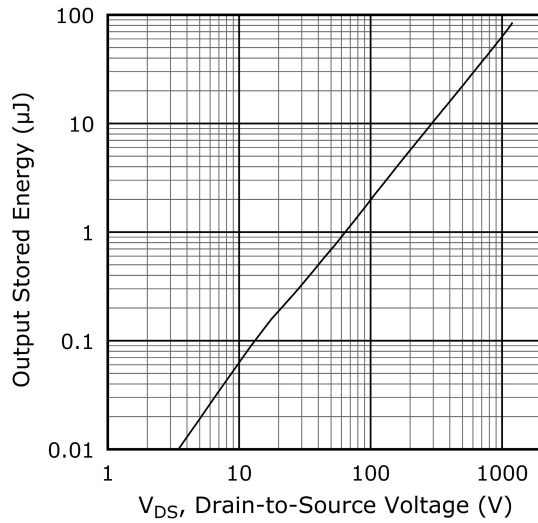

Figure 1-10.  $I_D$  vs.  $V_{DS}$  3<sup>rd</sup> Quadrant Conduction

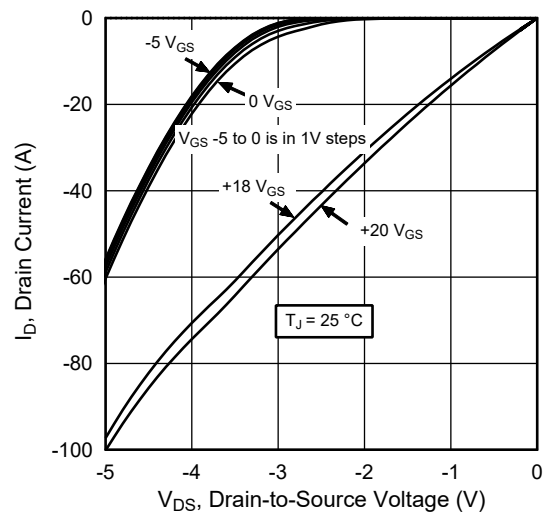

Figure 1-11.  $I_D$  vs.  $V_{DS}$  3<sup>rd</sup> Quadrant Conduction

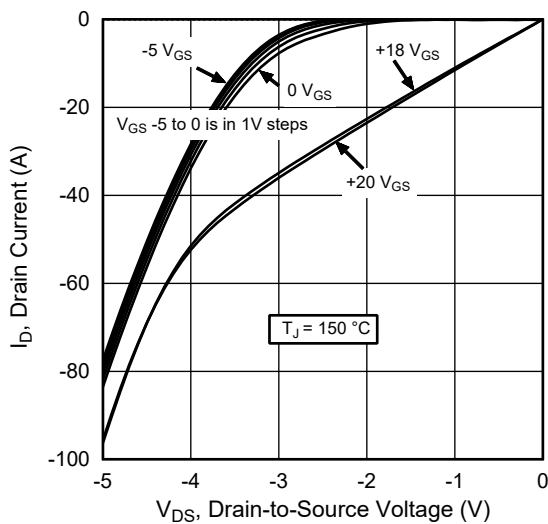

Figure 1-12. Switching Energy  $E_{on}$  vs.  $V_{DS}$  &  $I_D$

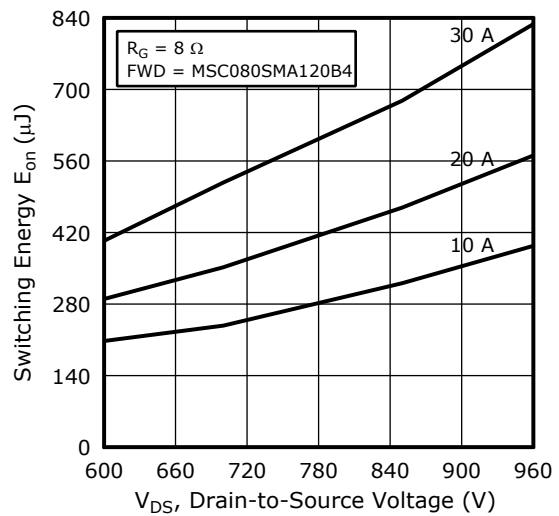

Figure 1-13. Switching Energy  $E_{off}$  vs.  $V_{DS}$  &  $I_D$

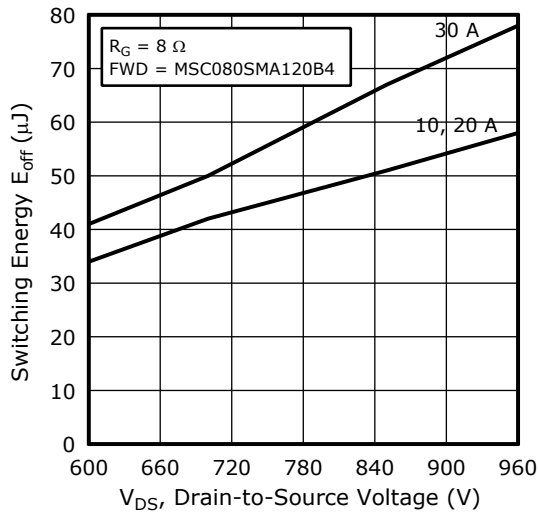

Figure 1-14. Switching Energy vs.  $R_G$

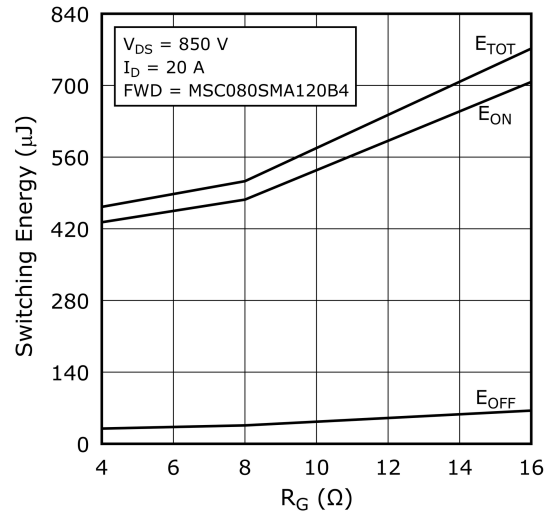

Figure 1-15. Switching Energy vs. Junction Temperature

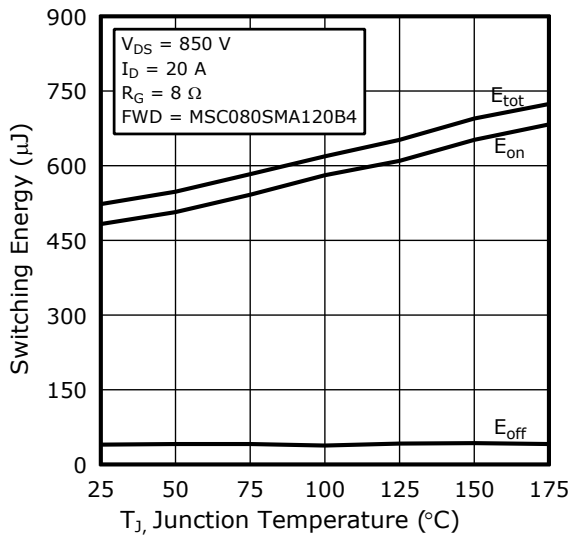

Figure 1-16. Threshold Voltage vs. Junction Temperature

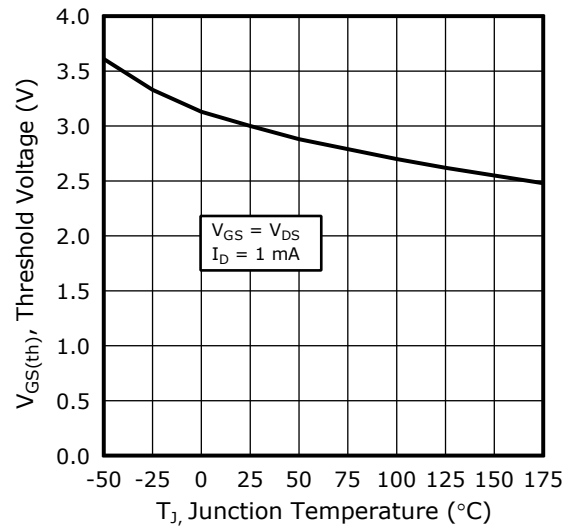

Figure 1-17. Forward Safe Operating Area

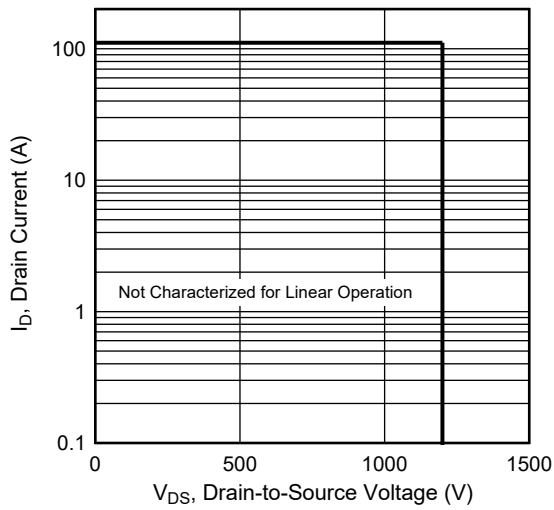
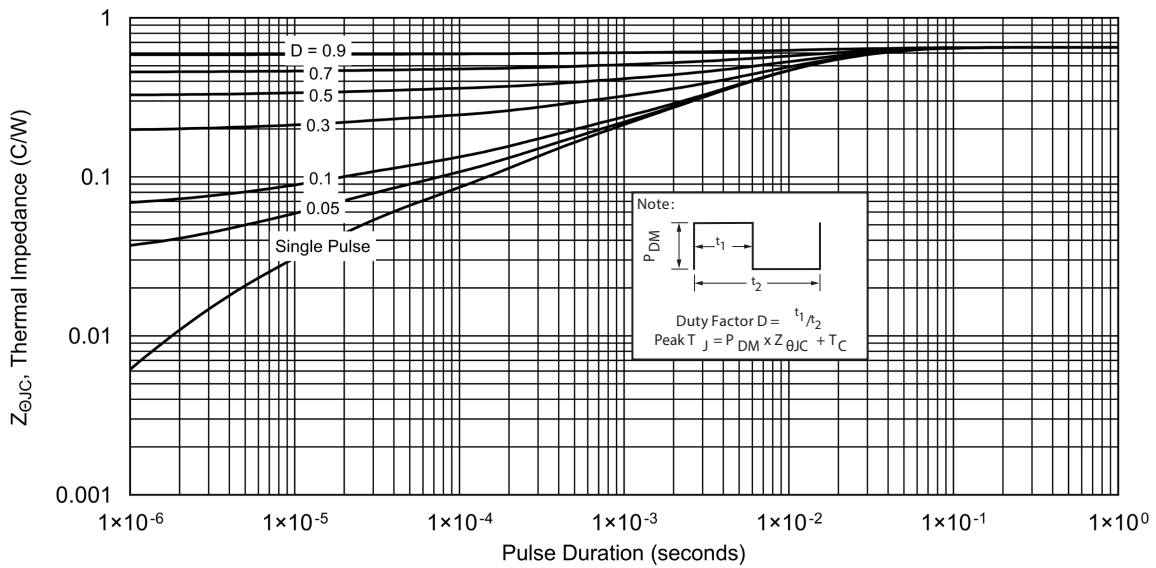
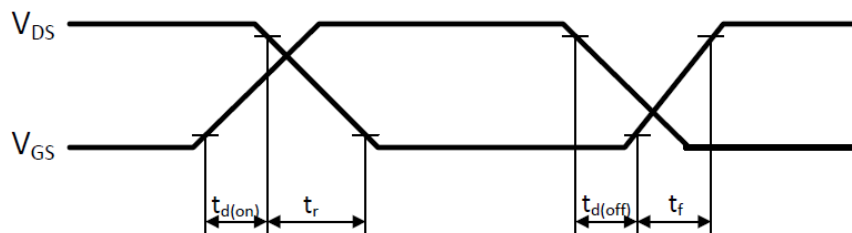

Figure 1-18. Maximum Transient Thermal Impedance



The following figure shows the switching waveform diagram of this device.

Figure 1-19. Switching Waveform





## 2. Package Specification

This section shows the package specification of this device.

### 2.1 Package Outline Drawing

The following figure illustrates the TO-247-4L package outline of this device.

Figure 2-1. Package Outline Drawing

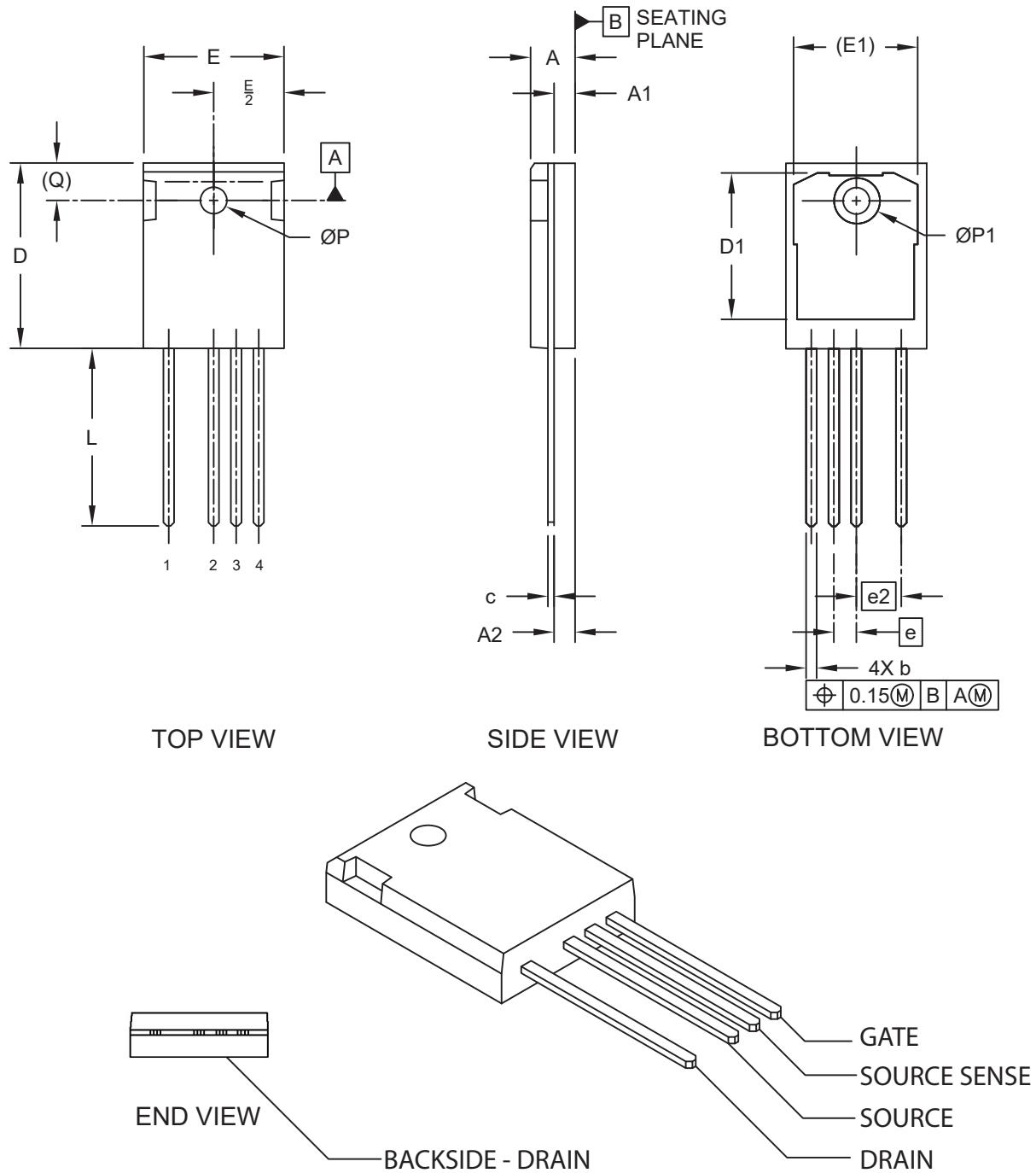

The following table shows the TO-247-4L dimensions and should be used in conjunction with the package outline drawing.

**Table 2-1. TO-247-4L Dimensions**

Symbol	Description	Min. (mm)	Max. (mm)
N	Number of leads	4	
e	Pitch	2.54 BSC	
e2	Pitch	5.08 BSC	
A	Overall height	4.90	5.18
A1	Tab height	1.85	2.10
A2	Seating plane to lead	2.26	2.51
b	Lead width	1.06	1.32
c	Lead thickness	0.55	0.68
L	Lead length	19.81	20.32
D	Molded body length	20.82	21.08
D1	Thermal pad length	16.25	16.84
E	Total width	15.77	16.02
E1	Thermal pad width	13.89	14.14
Q	Hole center to tab edge	6.14 REF	
∅P	Hole diameter	3.55	3.65
∅P1	Thermal pad hole diameter	7.11	7.49

**Notes:**

Dimensioning and tolerancing per ASME Y14.5M.

- BSC: Basic dimension. Theoretically exact value shown without tolerances.
- REF: Reference dimension, usually without tolerance, for information purposes only.

### 3. Revision History

The revision history describes the changes that were implemented in the document. The changes are listed by revision, starting with the most current publication.

**Table 3-1.** Revision History

Revision	Date	Description
D	07/2024	The following changes are made in this revision of the document: <ul style="list-style-type: none"> <li>• Updated <a href="#">1.1. Absolute Maximum Ratings</a></li> <li>• Added <a href="#">Figure 1-9</a></li> <li>• Updated <a href="#">2.1. Package Outline Drawing</a></li> <li>• Added <math>\tau_M</math> symbol for mounting torque in <a href="#">Table 1-2</a></li> </ul>
C	08/2022	The following changes are made in this revision of the document: <ul style="list-style-type: none"> <li>• Updated typical value for zero gate voltage drain current in <a href="#">Table 1-3</a>.</li> <li>• Updated typical values for diode forward voltage in <a href="#">Table 1-5</a>.</li> <li>• Updated <a href="#">Figure 1-7</a>.</li> </ul>
B	12/2022	The following changes are made in this revision of the document: <ul style="list-style-type: none"> <li>• Updated Values in <a href="#">Table 1-3</a></li> <li>• Updated values in <a href="#">Table 1-4</a></li> <li>• Updated an image in <a href="#">1.3. Typical Performance Curves</a></li> </ul>
A	08/2022	Document migrated from Microsemi template to Microchip template; Assigned Microchip literature number DS-00004673A, which replaces the previous Microsemi literature number 050-7755.
Initial release (Microsemi Revision A)	09/2019	Document created.

## Microchip Information

### The Microchip Website

Microchip provides online support via our website at [www.microchip.com/](http://www.microchip.com/). This website is used to make files and information easily available to customers. Some of the content available includes:

- **Product Support** – Data sheets and errata, application notes and sample programs, design resources, user’s guides and hardware support documents, latest software releases and archived software
- **General Technical Support** – Frequently Asked Questions (FAQs), technical support requests, online discussion groups, Microchip design partner program member listing
- **Business of Microchip** – Product selector and ordering guides, latest Microchip press releases, listing of seminars and events, listings of Microchip sales offices, distributors and factory representatives

### Product Change Notification Service

Microchip’s product change notification service helps keep customers current on Microchip products. Subscribers will receive email notification whenever there are changes, updates, revisions or errata related to a specified product family or development tool of interest.

To register, go to [www.microchip.com/pcn](http://www.microchip.com/pcn) and follow the registration instructions.

### Customer Support

Users of Microchip products can receive assistance through several channels:

- Distributor or Representative
- Local Sales Office
- Embedded Solutions Engineer (ESE)
- Technical Support

Customers should contact their distributor, representative or ESE for support. Local sales offices are also available to help customers. A listing of sales offices and locations is included in this document.

Technical support is available through the website at: [www.microchip.com/support](http://www.microchip.com/support)

### Microchip Devices Code Protection Feature

Note the following details of the code protection feature on Microchip products:

- Microchip products meet the specifications contained in their particular Microchip Data Sheet.
- Microchip believes that its family of products is secure when used in the intended manner, within operating specifications, and under normal conditions.
- Microchip values and aggressively protects its intellectual property rights. Attempts to breach the code protection features of Microchip product is strictly prohibited and may violate the Digital Millennium Copyright Act.
- Neither Microchip nor any other semiconductor manufacturer can guarantee the security of its code. Code protection does not mean that we are guaranteeing the product is “unbreakable”. Code protection is constantly evolving. Microchip is committed to continuously improving the code protection features of our products.

### Legal Notice

This publication and the information herein may be used only with Microchip products, including to design, test, and integrate Microchip products with your application. Use of this information in any other manner violates these terms. Information regarding device applications is provided only for your convenience and may be superseded by updates. It is your responsibility to ensure

that your application meets with your specifications. Contact your local Microchip sales office for additional support or, obtain additional support at [www.microchip.com/en-us/support/design-help/client-support-services](http://www.microchip.com/en-us/support/design-help/client-support-services).

THIS INFORMATION IS PROVIDED BY MICROCHIP "AS IS". MICROCHIP MAKES NO REPRESENTATIONS OR WARRANTIES OF ANY KIND WHETHER EXPRESS OR IMPLIED, WRITTEN OR ORAL, STATUTORY OR OTHERWISE, RELATED TO THE INFORMATION INCLUDING BUT NOT LIMITED TO ANY IMPLIED WARRANTIES OF NON-INFRINGEMENT, MERCHANTABILITY, AND FITNESS FOR A PARTICULAR PURPOSE, OR WARRANTIES RELATED TO ITS CONDITION, QUALITY, OR PERFORMANCE.

IN NO EVENT WILL MICROCHIP BE LIABLE FOR ANY INDIRECT, SPECIAL, PUNITIVE, INCIDENTAL, OR CONSEQUENTIAL LOSS, DAMAGE, COST, OR EXPENSE OF ANY KIND WHATSOEVER RELATED TO THE INFORMATION OR ITS USE, HOWEVER CAUSED, EVEN IF MICROCHIP HAS BEEN ADVISED OF THE POSSIBILITY OR THE DAMAGES ARE FORESEEABLE. TO THE FULLEST EXTENT ALLOWED BY LAW, MICROCHIP'S TOTAL LIABILITY ON ALL CLAIMS IN ANY WAY RELATED TO THE INFORMATION OR ITS USE WILL NOT EXCEED THE AMOUNT OF FEES, IF ANY, THAT YOU HAVE PAID DIRECTLY TO MICROCHIP FOR THE INFORMATION.

Use of Microchip devices in life support and/or safety applications is entirely at the buyer's risk, and the buyer agrees to defend, indemnify and hold harmless Microchip from any and all damages, claims, suits, or expenses resulting from such use. No licenses are conveyed, implicitly or otherwise, under any Microchip intellectual property rights unless otherwise stated.

## Trademarks

The Microchip name and logo, the Microchip logo, Adaptec, AVR, AVR logo, AVR Freaks, BesTime, BitCloud, CryptoMemory, CryptoRF, dsPIC, flexPWR, HELDO, IGLOO, JukeBlox, KeeLoq, Kleer, LANCheck, LinkMD, maXStylus, maXTouch, MediaLB, megaAVR, Microsemi, Microsemi logo, MOST, MOST logo, MPLAB, OptoLyzer, PIC, picoPower, PICSTART, PIC32 logo, PolarFire, Prochip Designer, QTouch, SAM-BA, SenGenuity, SpyNIC, SST, SST Logo, SuperFlash, Symmetricom, SyncServer, Tachyon, TimeSource, tinyAVR, UNI/O, Vectron, and XMEGA are registered trademarks of Microchip Technology Incorporated in the U.S.A. and other countries.

AgileSwitch, ClockWorks, The Embedded Control Solutions Company, EtherSynch, Flashtec, Hyper Speed Control, HyperLight Load, Libero, motorBench, mTouch, Powermite 3, Precision Edge, ProASIC, ProASIC Plus, ProASIC Plus logo, Quiet-Wire, SmartFusion, SyncWorld, TimeCesium, TimeHub, TimePictra, TimeProvider, and ZL are registered trademarks of Microchip Technology Incorporated in the U.S.A.

Adjacent Key Suppression, AKS, Analog-for-the-Digital Age, Any Capacitor, AnyIn, AnyOut, Augmented Switching, BlueSky, BodyCom, Clockstudio, CodeGuard, CryptoAuthentication, CryptoAutomotive, CryptoCompanion, CryptoController, dsPICDEM, dsPICDEM.net, Dynamic Average Matching, DAM, ECAN, Espresso T1S, EtherGREEN, EyeOpen, GridTime, IdealBridge, IGaT, In-Circuit Serial Programming, ICSP, INICnet, Intelligent Paralleling, IntelliMOS, Inter-Chip Connectivity, JitterBlocker, Knob-on-Display, MarginLink, maxCrypto, maxView, memBrain, Mindi, MiWi, MPASM, MPF, MPLAB Certified logo, MPLIB, MPLINK, mSiC, MultiTRAK, NetDetach, Omniscient Code Generation, PICDEM, PICDEM.net, PICkit, PICtail, Power MOS IV, Power MOS 7, PowerSmart, PureSilicon, QMatrix, REAL ICE, Ripple Blocker, RTAX, RTG4, SAM-ICE, Serial Quad I/O, simpleMAP, SimpliPHY, SmartBuffer, SmartHLS, SMART-I.S., storClad, SQI, SuperSwitcher, SuperSwitcher II, Switchtec, SynchroPHY, Total Endurance, Trusted Time, TSHARC, Turing, USBCheck, VariSense, VectorBlox, VeriPHY, ViewSpan, WiperLock, XpressConnect, and ZENA are trademarks of Microchip Technology Incorporated in the U.S.A. and other countries.

SQTP is a service mark of Microchip Technology Incorporated in the U.S.A.

The Adaptec logo, Frequency on Demand, Silicon Storage Technology, and Symmcom are registered trademarks of Microchip Technology Inc. in other countries.

GestIC is a registered trademark of Microchip Technology Germany II GmbH & Co. KG, a subsidiary of Microchip Technology Inc., in other countries.

All other trademarks mentioned herein are property of their respective companies.

© 2024, Microchip Technology Incorporated and its subsidiaries. All Rights Reserved.

ISBN: 978-1-6683-4175-9

## Quality Management System

For information regarding Microchip's Quality Management Systems, please visit [www.microchip.com/quality](http://www.microchip.com/quality).

# Worldwide Sales and Service

AMERICAS	ASIA/PACIFIC	ASIA/PACIFIC	EUROPE
<b>Corporate Office</b> 2355 West Chandler Blvd. Chandler, AZ 85224-6199 Tel: 480-792-7200 Fax: 480-792-7277 Technical Support: <a href="http://www.microchip.com/support">www.microchip.com/support</a> Web Address: <a href="http://www.microchip.com">www.microchip.com</a>	<b>Australia - Sydney</b> Tel: 61-2-9868-6733 <b>China - Beijing</b> Tel: 86-10-8569-7000 <b>China - Chengdu</b> Tel: 86-28-8665-5511 <b>China - Chongqing</b> Tel: 86-23-8980-9588 <b>China - Dongguan</b> Tel: 86-769-8702-9880 <b>China - Guangzhou</b> Tel: 86-20-8755-8029 <b>China - Hangzhou</b> Tel: 86-571-8792-8115 <b>China - Hong Kong SAR</b> Tel: 852-2943-5100 <b>China - Nanjing</b> Tel: 86-25-8473-2460 <b>China - Qingdao</b> Tel: 86-532-8502-7355 <b>China - Shanghai</b> Tel: 86-21-3326-8000 <b>China - Shenyang</b> Tel: 86-24-2334-2829 <b>China - Shenzhen</b> Tel: 86-755-8864-2200 <b>China - Suzhou</b> Tel: 86-186-6233-1526 <b>China - Wuhan</b> Tel: 86-27-5980-5300 <b>China - Xian</b> Tel: 86-29-8833-7252 <b>China - Xiamen</b> Tel: 86-592-2388138 <b>China - Zhuhai</b> Tel: 86-756-3210040	<b>India - Bangalore</b> Tel: 91-80-3090-4444 <b>India - New Delhi</b> Tel: 91-11-4160-8631 <b>India - Pune</b> Tel: 91-20-4121-0141 <b>Japan - Osaka</b> Tel: 81-6-6152-7160 <b>Japan - Tokyo</b> Tel: 81-3-6880-3770 <b>Korea - Daegu</b> Tel: 82-53-744-4301 <b>Korea - Seoul</b> Tel: 82-2-554-7200 <b>Malaysia - Kuala Lumpur</b> Tel: 60-3-7651-7906 <b>Malaysia - Penang</b> Tel: 60-4-227-8870 <b>Philippines - Manila</b> Tel: 63-2-634-9065 <b>Singapore</b> Tel: 65-6334-8870 <b>Taiwan - Hsin Chu</b> Tel: 886-3-577-8366 <b>Taiwan - Kaohsiung</b> Tel: 886-7-213-7830 <b>Taiwan - Taipei</b> Tel: 886-2-2508-8600 <b>Thailand - Bangkok</b> Tel: 66-2-694-1351 <b>Vietnam - Ho Chi Minh</b> Tel: 84-28-5448-2100	<b>Austria - Wels</b> Tel: 43-7242-2244-39 Fax: 43-7242-2244-393 <b>Denmark - Copenhagen</b> Tel: 45-4485-5910 Fax: 45-4485-2829 <b>Finland - Espoo</b> Tel: 358-9-4520-820 <b>France - Paris</b> Tel: 33-1-69-53-63-20 Fax: 33-1-69-30-90-79 <b>Germany - Garching</b> Tel: 49-8931-9700 <b>Germany - Haan</b> Tel: 49-2129-3766400 <b>Germany - Heilbronn</b> Tel: 49-7131-72400 <b>Germany - Karlsruhe</b> Tel: 49-721-625370 <b>Germany - Munich</b> Tel: 49-89-627-144-0 Fax: 49-89-627-144-44 <b>Germany - Rosenheim</b> Tel: 49-8031-354-560 <b>Israel - Hod Hasharon</b> Tel: 972-9-775-5100 <b>Italy - Milan</b> Tel: 39-0331-742611 Fax: 39-0331-466781 <b>Italy - Padova</b> Tel: 39-049-7625286 <b>Netherlands - Drunen</b> Tel: 31-416-690399 Fax: 31-416-690340 <b>Norway - Trondheim</b> Tel: 47-72884388 <b>Poland - Warsaw</b> Tel: 48-22-3325737 <b>Romania - Bucharest</b> Tel: 40-21-407-87-50 <b>Spain - Madrid</b> Tel: 34-91-708-08-90 Fax: 34-91-708-08-91 <b>Sweden - Gothenberg</b> Tel: 46-31-704-60-40 <b>Sweden - Stockholm</b> Tel: 46-8-5090-4654 <b>UK - Wokingham</b> Tel: 44-118-921-5800 Fax: 44-118-921-5820