

KR series

Power rocker switches



DISTINCTIVE FEATURES

- Unique rocker design
- Wide choice of colors
- Laser etched symbols
- Illuminated or non-illuminated
- Optionally sealed to IP68 or IP69K



ENVIRONMENTAL SPECIFICATIONS

- Sealing options :
 - K : IP68 to front panel components of switch only according to IEC 60529
 - Z : IP69K panel sealing according to DIN 40050-9
- Salt spray resistance : 96 hours according to IEC 512-6, test 11f
- Vibration resistance : 10-500 Hz / 10 g per IEC 60068-2-6
- Operating temperature : -40 °C to +85 °C (-40 °F to +185 °F)



ELECTRICAL SPECIFICATIONS

- Current/voltage rating with resistive load :
 - Silver plated contacts :
 - A : 5 A 24 VDC, 100,000 cycles
 - 10 A 24 VDC, 10,000 cycles (terminals 6.35 x 0.8 only)
 - S : 20 A 12 V, 10,000 cycles (see "Build your part number")
 - Gold plated contacts (D) : 20 mA 12 V, 150,000 cycles
- Current/voltage rating with lamp load - silver contacts (A) :
 - functions 1 & 6 : 100 W 24 VDC, 10,000 cycles
 - other functions : 60 W 24 VDC, 10,000 cycles
- Initial contact resistance : 10 mΩ max.
- Insulation resistance : 1,000 MΩ min. at 500 VDC
- Dielectric strength : 2,000 Vrms 50 Hz min. between terminals



GENERAL SPECIFICATIONS

- Mechanical life : 150,000 cycles min.
- Panel thickness : 0.8 mm to 4.6 mm
- Recommended panel thickness : between 2 mm and 3.5 mm

The company reserves the right to change specifications without notice.



KR series

Power rocker switches



MATERIALS

- Case : PA 6-6
- Actuator : ABS
- Bezel : PA 6-6
- Contacts & terminals :
brass, solid silver grain, silver plated (A or S)
or brass, solid silver grain, gold plated (D)
- Contact roller : brass, nickel plated

APEM products may be recycled at end-of-life for the re-claiming of valuable metal components.



SEALING

- Sealing is optional. To order a sealed product, complete the appropriate box of ordering format on the following pages.



MATRIX MOUNTING

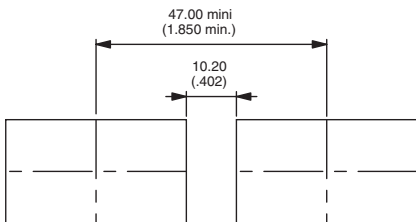
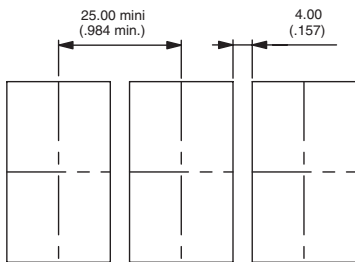

PANEL CUT-OUT

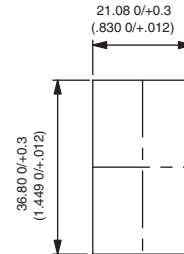

SPECIFIC MATRIX MOUNTING FOR Z VERSION

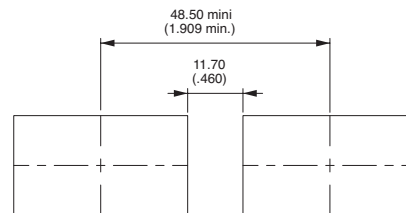
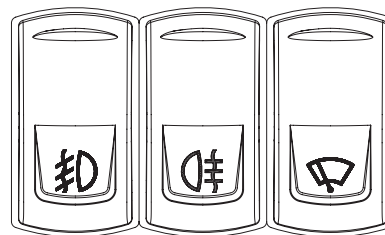
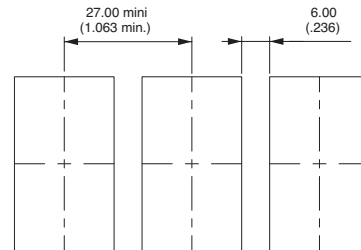



ELECTRICAL FUNCTIONS AND CONNECTIONS

In the tables below, terminal connections as viewed from bottom of switch. Only the contact area is represented. For single pole models, only terminals 1, 2 and 3 are to be considered (not terminals 6, 5, 4).

x = w/o terminal
 o = with terminal
 ▲ = momentary

2 POSITIONS

Function 1 * KR31-KR41		
Function 5 KR35 - KR45		
Function 6 KR36-KR46		

* Function 1 : Only available for 6 terminal versions.

3 POSITIONS

Function 7 KR37-KR47			
Function 8 KR38-KR48			
Function 9 KR39-KR49			
Function 4 KR44			
Function 4-1R KR44-1R			



TERMINALS

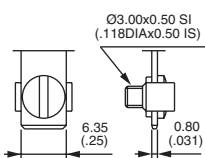

Screw

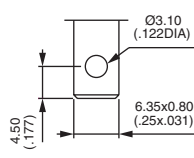

Solder lug / quick-connect

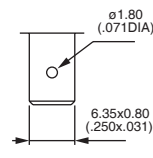

Normalized quick-connect 6.35x0.8

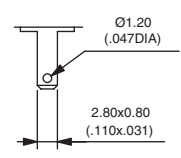

Normalized quick-connect 2.8x0.8

KR series

Power rocker switches



BUILD YOUR PART NUMBER

- To order a complete product, fill in all the boxes of the following order guide.
- To order case only (without actuator), finish your order number with the LED wiring code.
- To order actuator only (without case), begin the order number with code KRR, then follow the order format from "actuator type" until the end of the options.

CASE + LEADS

KR							Side A	Side B	
SERIES	POLES	ELECTRICAL FUNCTIONS			CONTACTS	SEALING	LEADS		
3 Single pole		1 ON - OFF			A Silver	X No			
4 Double pole		4 ON ON ON			D Gold plated	K IP68			
		4-1R ON ON MOM			S Silver 20A***	Z IP69K	X None	F LED 12 V yellow	
		5 MOM - ON					A LED 6 V red	N LED 12 V blue	
		6 ON - ON					B LED 6 V green	S LED 12 V white	
		7 MOM OFF MOM					C LED 6 V yellow	J LED 24 V red	
		8 ON OFF MOM					M LED 6 V blue	K LED 24 V green	
		9 ON OFF ON					R LED 6 V white	L LED 24 V yellow	
							D LED 12 V red	P LED 24 V blue	
							E LED 12 V green	T LED 24 V white	
									etc.
					TERMINALS				
					Screw	Normalized quick-connect 6.35x0.8	Normalized quick-connect 2.8x0.8		
					0 6 terminals with barrier	3 6 terminals with barrier	G 10 term. with barrier		
					Solder lug/quick-connect	5 6 terminals w/o barrier	H 10 term. w/o barrier		
					2 6 terminals with barrier	D 10 term. with barrier	J 10 terminals for use with connector U2282		
					4 6 terminals w/o barrier	E 10 term. w/o barrier			
					A 10 term. with barrier	F 10 term. for use with connector U2292 or U3152			
					B 10 term. w/o barrier				
					C 10 terminals for use with connector U2292 or U3152				

Function 1 only for 6-terminal versions.

***S contacts for all functions except 44-1R - for normalized quick-connect terminals 6.35x0.8 only.

ACTUATOR

			Area A	Area M	Area B
TYPE	COLOR	MARKING ORIENTATION	SYMBOLS		
1 For non-illuminated application	1 Blue	5 Yellow			
2 For illuminated application	1/4 Dark blue	6 Red			
	2 Black	7 Ivory			
	3 Green	9 Orange			
	4 Grey		N North		
			O West		
			S South		
			E East		

Symbols & Accessories : see end of the series.

NOTICE : please note that not all combinations of above numbers are available. Refer to the following pages for further information.

KR series

Power rocker switches

6 TERMINAL VERSION



		2-3 5-6		1-2 4-5
Single pole	Double pole			
KR31	KR41	ON	-	OFF
	KR44*	ON	ON	ON
	KR44-1R*	ON	ON	MOM
	KR45*	MOM	-	ON
KR36	KR46	ON	-	ON
KR37	KR47	MOM	OFF	MOM
KR38	KR48	ON	OFF	MOM
KR39	KR49	ON	OFF	ON

*Function 4 and 5: single pole in double pole case

10 TERMINAL VERSION



		2-3 5-6		1-2 4-5
Single pole	Double pole			
	KR44*	ON	ON	ON
	KR44-1R*	ON	ON	MOM
KR35	KR45	MOM	-	ON
KR36	KR46	ON	-	ON
KR37	KR47	MOM	OFF	MOM
KR38	KR48	ON	OFF	MOM
KR39	KR49	ON	OFF	ON

*Function 4 : single pole in double pole case

→ FLAT SEAL

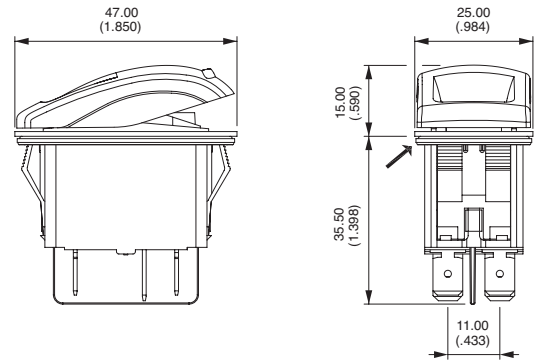

→ FLAT SEAL

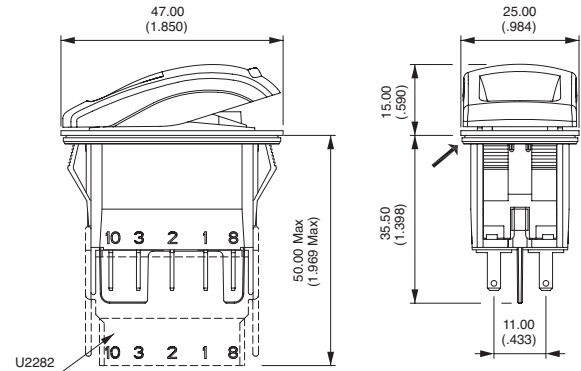

CASE + LEDS

TERMINALS

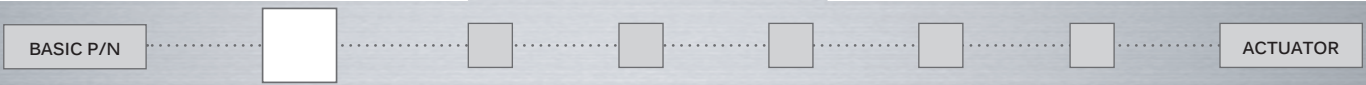

To order case only (without actuator), finish your order number with the LED wiring code.

SCREW

0 6 terminals with barrier

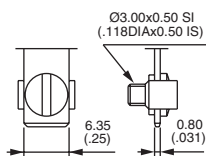

screw

SOLDER LUG / QUICK-CONNECT

- 2 6 terminals with barrier
- 4 6 terminals w/o barrier
- A 10 terminals with barrier
- B 10 terminals w/o barrier
- C 10 terminals for use with connector U2292 or U3152

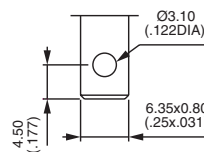

Solder lug / quick-connect

KR series

Power rocker switches

CASE + LEDS

**TERMINALS
(CONTINUED)**



NORMALIZED QUICK-CONNECT 6.35X0.8

- 3 6 terminals with barrier
- 5 6 terminals w/o barrier
- D 10 terminals with barrier
- E 10 terminals w/o barrier
- F 10 terminals for use with connector U2292 or U3152

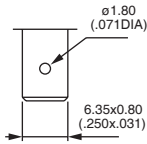

Normalized quick-connect 6.35x0.8

NORMALIZED QUICK-CONNECT 2.8X0.8

- G 10 terminals with barrier
- H 10 terminals w/o barrier
- J 10 terminals for use with connector U2282

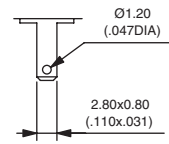

Normalized quick-connect 2.8x0.8

6 TERMINAL VERSION

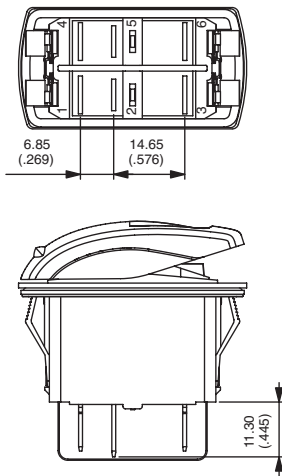

10 TERMINAL VERSION

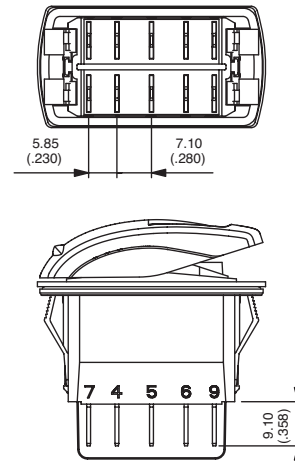

Terminals are marked on the case. The drawings show the maximum possible number of terminals.

CASE + LEDS

CONTACT MATERIALS



- A Silver
- D Silver, gold plated
- S Silver 20A. For all functions except 44-1R - for normalized quick-connect terminals 6.35x0.8 only.

KR series

Power rocker switches

CASE + LEDES

SEALING



- X No sealing
- K IP68 (front panel components of switch only)
- Z IP69K - Installation notice available on request

Ultrasonic welding of frame to case is standard on all versions. The ultrasonic welding and the optional panel seal prevent water and dust from introducing into the switch housing.

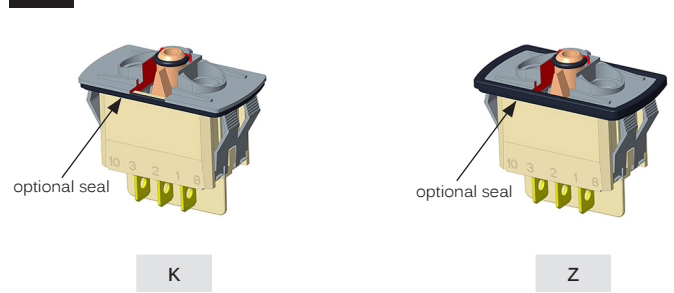

CASE + LEDES

LEDES



Complete each enlarged box with one of the codes listed below.

- X Without LED

	Red	Green	Yellow	Blue	White	Amber	Red/green
6 VDC	A	B	C	M	R	4	1
12 VDC	D	E	F	N	S	5	2
24 VDC	J	K	L	P	T	6	3
No resistor	U	V	W	Y	Z	9	8

LED consumption : 20 mA @ nominal voltage (25 °C / 77 °F)
 Other illumination solutions : on request.

For non-stabilized on-board power supplies submitted to potential voltage surges due to the alternator, 15 V and 30 V LED configurations are also available on request.

LED Tolerance $\pm 10\%$

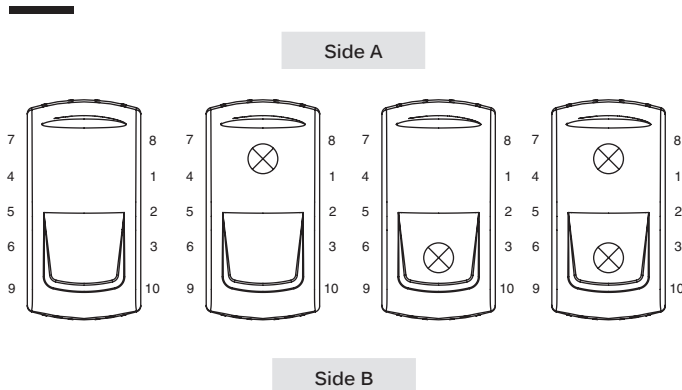

KR series

Power rocker switches

CASE + LEDS

WIRING

BASIC P/N

ACTUATOR

The LED wiring diagram is shown on the case.

FOR 6 TERMINAL VERSIONS - LED CONNECTED TO THE LOAD

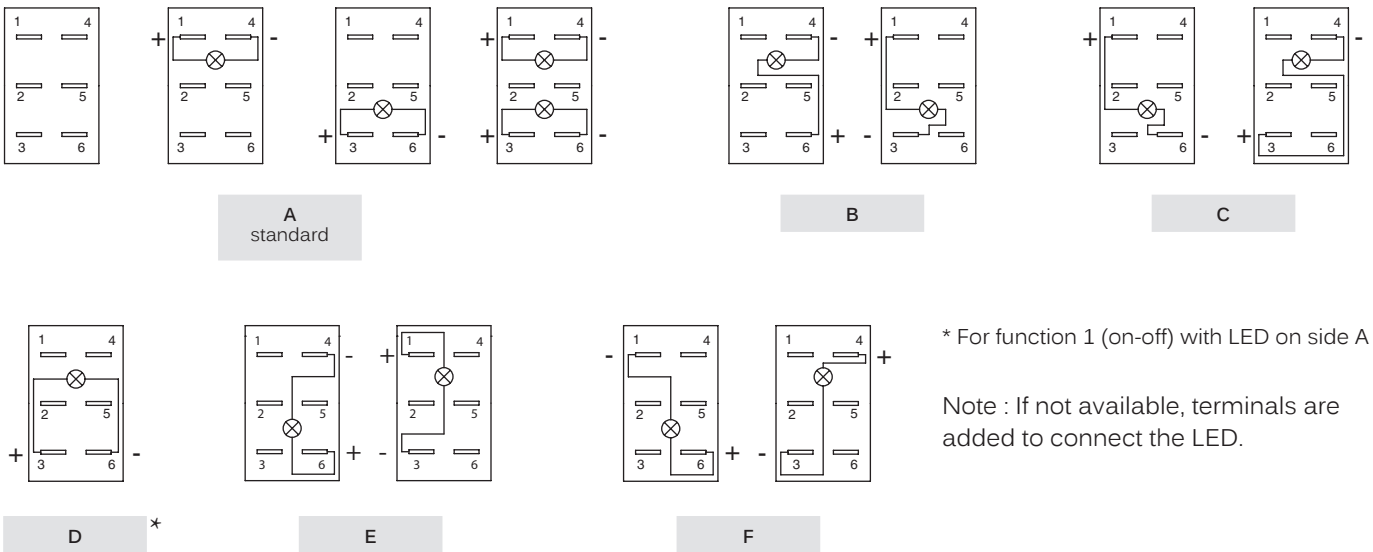

* For function 1 (on-off) with LED on side A

Note : If not available, terminals are added to connect the LED.

FOR 10 TERMINAL VERSIONS - INDEPENDENT LED OR INTEGRATED FUNCTIONS

G Standard, to have independent LED.

H To obtain 2 symbol illumination levels (night illumination when OFF and higher illumination when ON).

- H wiring with LED on side A available with functions 6, 8, 9 and 44.
- H wiring with LED on side B available with functions 5, 6 and 9.
- H wiring with 2 LEDs available with functions 8 and 9.

More information (H wiring schematics) : on request.
Dotted line = external wiring, continuous line = internal wiring

Available in Single Pole only, with H and J quick-connect terminals.

I To have a polarity inversion (typical application : fan motor).

Dotted line = external wiring

Power supply between 2 and 5 - Load between 1 and 4 or 3 and 6.

Available with H and J quick-connect terminals.

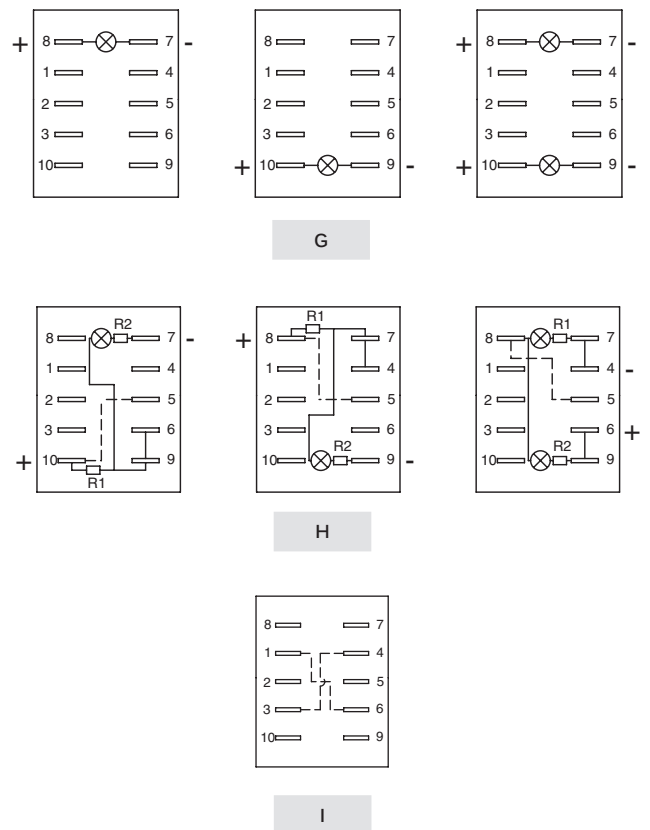

Please contact us for other wiring solutions.

KR series

Power rocker switches

ACTUATOR

ACTUATOR TYPE



To order actuator only (without case), begin the order number with code KRR, then follow the order format from "actuator type" until the end of the options.

- 1 For non-illuminated application
- 2 For illuminated application

Other rocker design : on request.



ACTUATOR

ACTUATOR COLOR



- 1 Blue
- 1/4 Dark blue
- 2 Black
- 3 Green
- 4 Grey
- 5 Yellow
- 6 Red
- 7 Ivory
- 7/1 White
- 9 Orange



Note : color 7 and 7/1 not available on illuminated versions.

A soft-touch varnish can be added. Consult us.

ACTUATOR

MARKING ORIENTATION

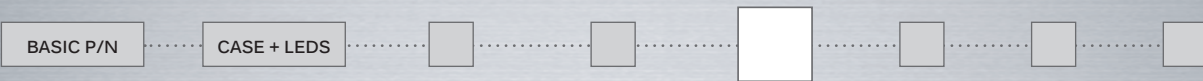

If no marking required, complete the box with code N.

Other orientations : on request

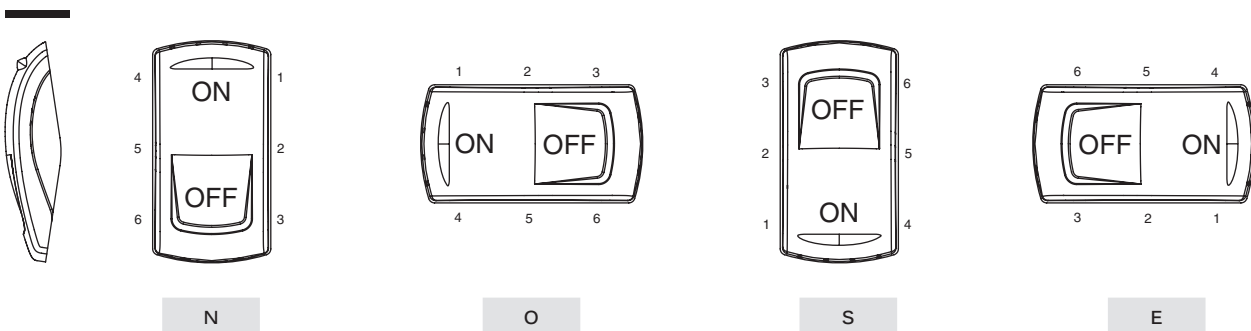

KR series

Power rocker switches

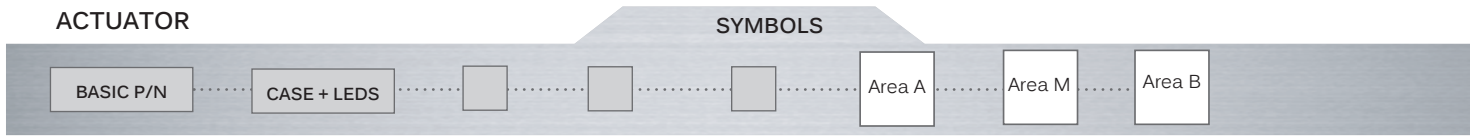

XX No symbol
 If no marking required, end up the part number with
 Actuator marking orientation (see above)

Available symbols : Complete each enlarged box with the one of the codes listed on the following pages.

Marking color : White marking for illuminated rockers (laser etching) and non-illuminated black rockers (pad printing). Black marking for non-illuminated color rockers (pad printing).
 Other : on request.

Laser etching resistance

- Water and petrol resistant according to EN 61058-1
- Tear resistant (cross-cut test) according to NF ISO 2409 : class 0
- UV resistant according to ISO 4892-2

Marking area

For illuminated versions. The symbol will be included in the hatched area. Marking in M area : on request.

MARKING AREA

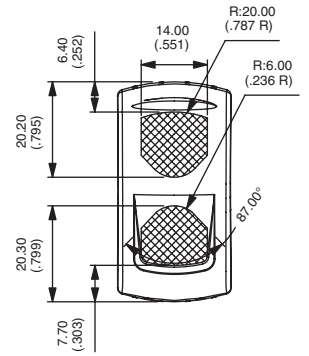
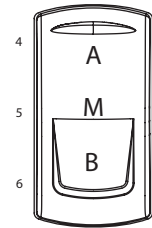

K range

Power rocker switches and indicators • symbols and accessories

Most symbols meet the ISO 7000 standard “graphical symbols for use on equipment” (code given in bracket in the description).

Contact us for symbols not featured in the following tables.

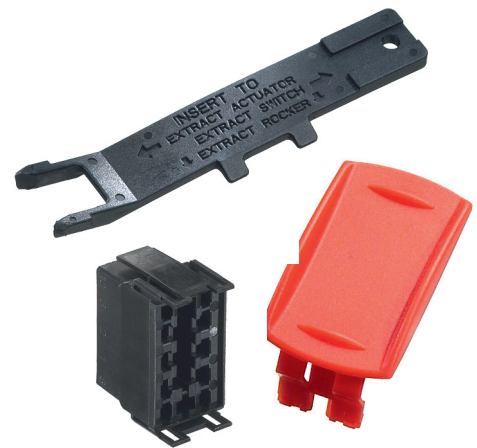

CODE	SYMBOL	DESCRIPTION	CODE	SYMBOL	DESCRIPTION	CODE	SYMBOL	DESCRIPTION
XX	None	-	16		Revolving light	32		Emergency first aid vehicle (2565)
01	ON	-	17		Rear ventilator	33		Load tipping (1557)
02	OFF	-	18		Heating (0637)	34		Loading light (2457)
03	O	-	19		Door opening	35		Tractor, rear-ward (1667)
04	I	-	20		Windshield demister/defroster (0635)	36		Combine, direction of movement (1678)
05	II	-	21		Windshield wiper (0086)	37		Use no forks (2406)
06	STOP	-	22		Windshield washer (0088)	38		Transmission (1166)
07	A	Stop	23		Ventilator fan (0089)	39		Working spot light (1145)
08	M	Motion	24		Side mirror defroster	40		Engine (0640)
09		Up motion	25		Restarting pump	41		Horn (0244)
10		Down motion	26		Front fog lights (0633)	42		Lock (1656)
11		Hot	27		Rear fog lights (0634)	43		Taxi sign light (2551)
12		Cold	28		Propulsion system trim	44		Working light (1204)
13		Hazard warning (0085)	29		Beacon (1141)	45		Working light symmetric (1204)
14		Traveller lighting	30		Anchor	46		-
15		Driver lighting (1421)	31		Electric motor (0011)	47	ASM	-

















K range





Power rocker switches and indicators • symbols and accessories

CODE	SYMBOL	DESCRIPTION	CODE	SYMBOL	DESCRIPTION	CODE	SYMBOL	DESCRIPTION
48		All wheel drive	69		Engine idle control	90		ECAS reset
49		Differential lock (1662)	70		Cruise res/set	91		Driver windows heating
50		-	71		Driver windows up/down	92		Cruise set
51		-	72		Middle door opening	93		Air bag up/down
52		-	73		Front door opening	94		Read lighting
53		-	74		Lighting in baggage room	95		Lighting main switch
54		Rear window wiper (0097)	75		Cruise on/off	96		Heating using water
55		Rear window washer (0099)	76		TV	97		Low beam
56		Lower load (2223)	77		Pump	98		Position lights
57		Cab lock (1560)	78		Toilet	99		Diesel acceleration
58		Extraction	79		Toilet decontamination	A1		Manual mode
59		Pumping in	80		Front windshield heating	A2		Clockwise cabin rotation
60		Rear PTO (1572)	81		Aus	A3		Anticlockwise cabin rotation
61		Front PTO	82		Radiator fan	A4		-
62		Rockshaft down	83		Remove retarder	A5		-
63		Rockshaft up	84		Restricted speed	A6		Parking brake
64		Indicator	85		Preheater	A7		-
65		Brake release	86		ABS detection	A8		-
66		Baggage room left door	87		ECAS detection	A9		-
67		Baggage room right door	88		Engine stop	AA		-
68		Power blinds	89		Cruise res/cancel	AB		-

K range

Power rocker switches and indicators • symbols and accessories

CODE	SYMBOL	DESCRIPTION
AC		-
AD		-
AE		-
AF		-
AG		Battery charging condition (0247)
AH		Turn signals (0084)
AJ		High beam (0082)
AK		Differential lock, bogie (2600)
AL		Brushing with a rotating brush (0070)
AM		Differential lock, transfer case 4x4 (2475)
AN		Loader bucket, float (1441)
AP		Loader bucket (1437)
AQ		Rear window washer & wiper (0098)
AR		Header, Header drive (1579)
AS		Excavator/backhoe boom side shift (2091)
AT		Chemical water treatment (1851)
AU		Grapple skidder, single funct* boom (1762)

CODE	SYMBOL	DESCRIPTION
AV		-
AW		-
AY		-
AZ		-
B1	HIGH	-
B2	LOW	-
B3		-

Legend scale

Depending on space available on the product (see "Symbols" section at the end of each series).

K range

Power rocker switches and indicators • symbols and accessories

MOUNTING PANELS

MOUNTING PANEL END

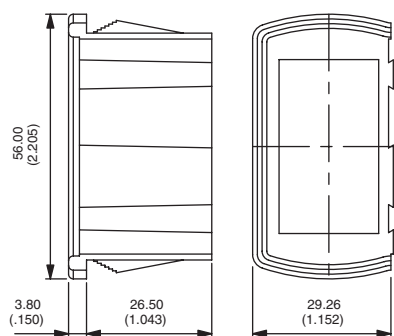

U2261

MOUNTING PANEL MIDDLE

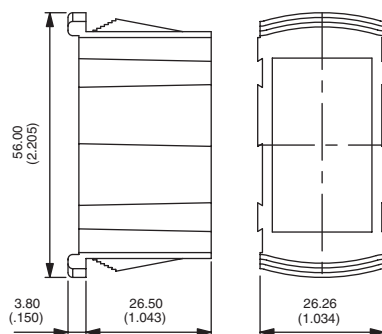
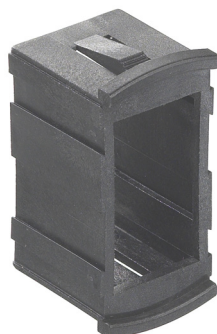

U2262

SINGLE MOUNTING PANEL

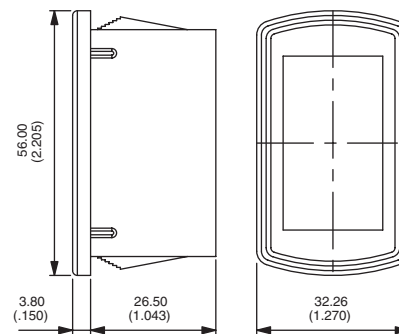
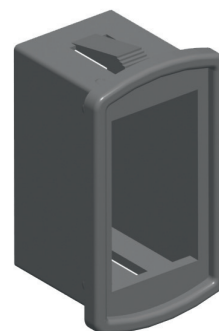

U2267

Recommended panel thickness : 1.10 mm - 1.80 mm - 2.60 mm - 3.40 mm - 4.20 mm - 5 mm - 5.80 mm

MOUNTING PANEL CUT-OUT

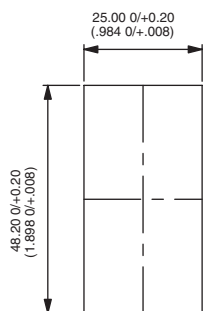

For 1 element U2267

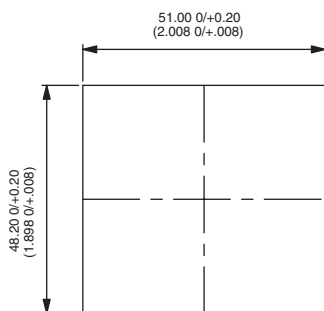

For 2 elements U2261

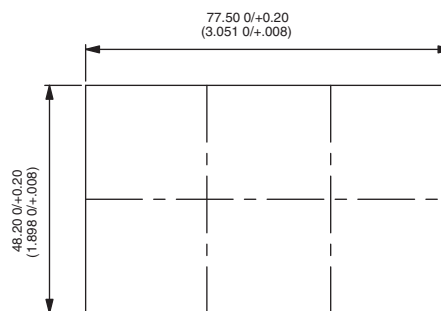

For 3 elements (2xU2261 + 1x U2262)

For additional elements, add 26.40 mm (1.039)

K range

Power rocker switches and indicators • symbols and accessories

22 X 44 ADAPTERS

FRONT PANEL DISMOUNTING

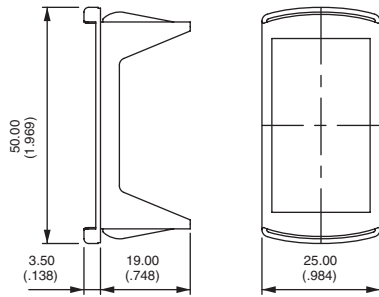

U3060

REAR PANEL DISMOUNTING

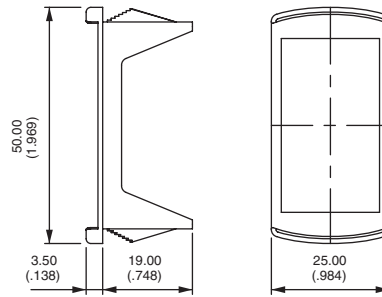

U3070

PANEL CUT-OUT

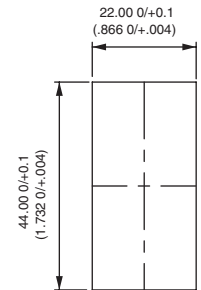

Recommended panel thickness

U3060 0.60 mm to 1.50 mm

U3070 1.60 mm -0.1/0 to 5.60 mm -0.1/0 in stages of 0.40 mm

Adapter colors (replace 0 with code)

- 1/4 Dark blue
- 2 Black
- 4 Grey
- 5 Yellow
- 6 Red
- 7/1 White

ACTUATOR REMOVING TOOL

Extract actuator (KR only)

Allows the extraction of the rocker / rocker support assembly. Place the 2 claws under the support and push as indicated by the arrow.

Extract rocker (KR only)

Allows to separate the rocker from its support. Insert the tool between rocker and support as indicated by the arrow. Pull out the tool in the opposite direction.

Extract switch (KR, KL and KI)

Allows to extract switch from panel mounting units. 2 Tools are necessary. Insert the tools between switch and panel mounting units from the rear to compress the snap-in device. Pull off switch manually.



U3052

2 tools are supplied

BLANKING CAPS

Usefull for future extensions.

Connectors can be hanged on specific hole plugs. Contact APEM.

- | | | | |
|---------|-----------|-------|--------|
| U2271 | Blue | U2275 | Yellow |
| U2271/4 | Dark blue | U2276 | Red |
| U2272 | Black | U2277 | Ivory |
| U2273 | Green | U2279 | Orange |
| U2274 | Grey | | |

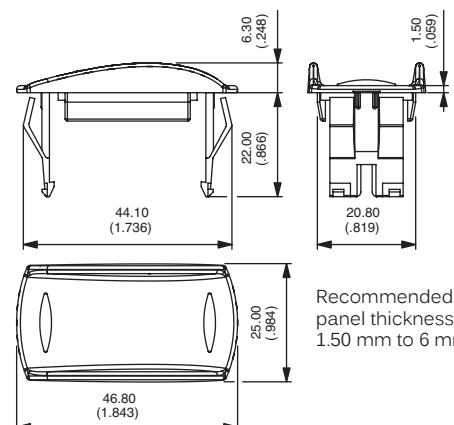

K range

Power rocker switches and indicators • symbols and accessories

CONNECTORS

Standard color : black. Other colors : on request. Connectors cannot be combined with wiring types H and I.

U2260 6 terminal version. For use with terminals type 2, 3, 4 or 5.
6.35 (1/4) tabs to be fitted by the user (example : TE42282-2).
Can be used for the KG series.

U2282 10 terminal version. For use with terminals type H or J.
2.8 (.110) tabs to be fitted by the user (example : AMP/Tyco 0-927779-3).

U2292 10 terminal version : For use with terminals type B, C, E or F.
6.35 (1/4) tabs to be fitted by the user (example : TE42282-2).

U3152 10 terminal version. For use with terminals type B, C, E or F.
6.35 (1/4) tabs to be fitted by the user (example : "Timer" terminals TE927833-2)

