

● **特点(Features):**

1. 电流转换比(CTR: 最小 50% 工作条件 $I_F=5mA, V_{CE}=5V$)
Current conversion ratio (Min 100% Working condition $I_F=5mA, V_{CE}=5V$)
2. 绝缘电压: ($V_{ISO}=5,000Vrms$) Insulation Voltage = 5,000Vrms
3. 响应时间 (tr: TYP. 6 μ s; tf: TYP. 5 μ s)工作条件 $V_{CE}=2V, I_C=2mA, R_L=100 \Omega$
Response Time (tr: TYP. 6 μ s; tf: TYP. 5 μ s)working condition $V_{CE}=2V, I_C=2mA, R_L=100 \Omega$)
4. ESD: HBM8000V&MM2000V

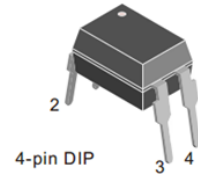

● **说明 (Instructions)**

1. PC817 系列光耦合器的组成是: 由一个 GaAs 的发射管和一个 NPN 的晶体管组成
PC817 photocoupler consist of one piece of GaAs emitter and one piece of NPN transistor
2. PC817 的引脚中心距是 2.54mm Pin pitch of PC817 is 2.54mm

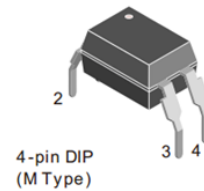

● **应用范围 (Application Range)**

1. 开关电源.Switching power supply
2. 电表.Ammeter
3. 电脑. Computer
4. 器具的应用, 测量机. Instrumental application, measurement machine
5. 贮存器, 复印机, 自动售货机. Imbursement equipments, duplicating machine, automat
6. 家用电器, 如风扇等. Family-use electric equipments, such as fans
7. 信号传输系统. Signal transforming systems

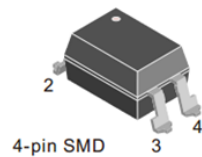

● **Block Diagram and Package 框架结构**

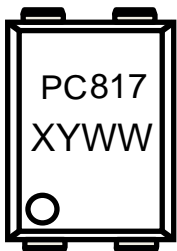
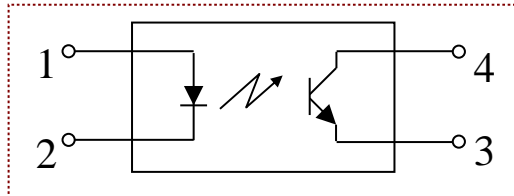

●The "x" in the printed word represents the product segment: A、B、C、D or others
印字中的“x”代表产品 CTR 分档 : A、B、C、D 等

● "Y " represents the year; "WW" represents the week

印字中“ Y ”代表年份 ; “WW”代表星期

● The "GK" in the printed word represents the product brand

印字中的“GK”代表产品品牌

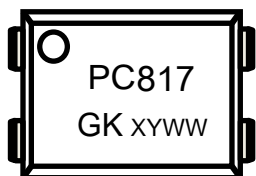

PC817

● 最大绝对额定值 (常温=25°C) Max Absolute rated Value (Normal Temperature=25°C)

参数 Parameter		符号 Symbol	额定值 Rated Value	单位 Unit
输入 Inout	顺向电流 Forward Current	I_F	50	mA
	逆向电压 Reverse Voltage	V_R	6	V
	功耗率 Consume Power	P	70	mW
输出 Output	集极与射极电压 Collector and emitter Voltage	V_{CEO}	35	V
	射极与集极电压 Emitter and collector Voltage	V_{ECO}	6	
	集极电流 Collector Current	I_C	50	mA
	消耗功率 Consume Power	P_C	150	mW
总功率消耗 Total Consume Power		P_{tot}	200	mW
*1 绝缘电压 Insulation Voltage		V_{iso}	5,000	Vrms
最大绝缘电压 Max Insulation Voltage		V_{IOTM}	6,000	V
额定脉冲绝缘电压 Rated Impulse Insulation Voltage		V_{IORM}	630	V
工作温度 Working Temperature		T_{opr}	-55 to + 110	°C
存贮温度 Deposit Temperature		T_{stg}	-55 to + 125	
*2 焊锡温度 Soldering Temperature		T_{sol}	260	

*1. 交流测试, 时间 1 分钟, 湿度. =40~60% AC Test, 1 minute, humidity = 40~60%

如下是绝缘测试的方法. Insulation test method as below:

- (1) 将产品的两端短路。 Short circuit both terminals of photocoupler
- (2) 测试绝缘电压时无电流通过。 No Current when testing insulation voltage
- (3) 测试时加正弦波形电压。 Adding sine wave voltage when testing

*2. 锡焊时间为 10 秒 soldering time is 10 seconds

● 光电特性(常温=25°C) Opto-electronic Characteristics

参数 Parameter		符号 Symbol	条件 Condition	最小 Min	中.Mid ium	最大 Max	单位 Unit
输入 Input	顺向电压 Forward Current	V_F	$I_F=20mA$	---	1.20	1.40	V
	逆向电压 Reverse Voltage	I_R	$V_R=5V$	---	---	5	uA
	集极电容 Collector capacitance	C_t	$V=0, f=1MHz$	---	30	250	pF
输出 Output	集极至射极电流 Collector to emitter Current	I_{CEO}	$V_{CE}=70V, I_F=0mA$	---	---	150	nA
	集极与射极衰减电压 Collector and Emitter attenuation Voltage	BV_{CEO}	$I_C=0.1mA, I_F=0mA$	70	---	---	V
	射极与集极衰减电压 Emitter and Collector attenuation Voltage	BV_{ECO}	$I_E=10\mu A, I_F=0mA$	6	---	---	V

PC817

传输特性 Transforming Characteristics	*1 电流转换比 Current conversion ratio	CTR	I _F =5mA V _{CE} =5V	50	---	600	%
	集极与射极饱和电压 Collector and Emitter Saturation Voltage	V _{CE(sat)}	I _F =20mA I _C = 1mA	---	0.1	0.2	V
	绝缘阻抗 Insulation Impedance	R _{iso}	DC500V 40~60%R.H.	5×10 ¹⁰	1×10 ¹¹	---	Ω
	电容量 capacitance	C _f	V=0, f=1MHz	---	0.6	1	pF
	转换频率 Transforming Frequency	f _c	V _{CE} =5V, I _C =2mA R _L =100Ω, -3dB	---	80	---	kHz
	上升时间 Rise time	t _r	V _{CE} =2V, I _C =2mA R _L =100Ω	---	6	18	μs
	下降时间 Descend Time	t _f		---	5	18	μs

● 电流转换比 Current Conversion Ratio = $I_C / I_F \times 100\%$

● 电流转换比的等级分类 Grades of Current conversion ratio

等级标示 Grade Sign	最小 .Min (%)	最大 .Max (%)
A	100	160
B	130	260
C	200	400
D	300	600
A or B or C or D	50	600

说明：工作条件: I_F=5mA, V_{CE}=5V, T_a=25°C.

Note: Working condition: I_F=5mA, V_{CE}=5V, T_a=25°C.

RATING AND CHARACTERISTIC CURVES (PC817)

Fig.1 Forward Current vs. Ambient Temperature

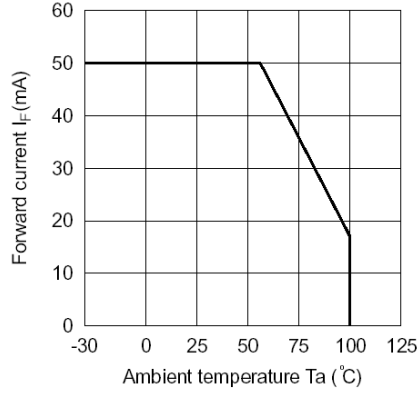

Fig.2 Collector Power Dissipation vs. Ambient Temperature

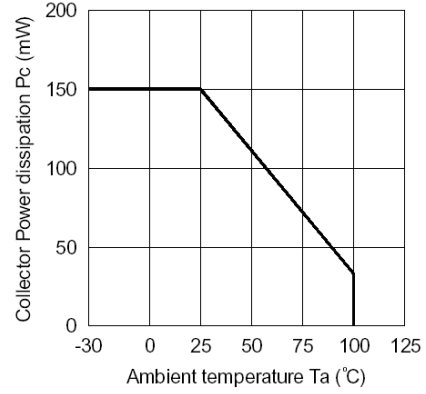

Fig.3 Collector-emitter Saturation Voltage vs. Forward Current

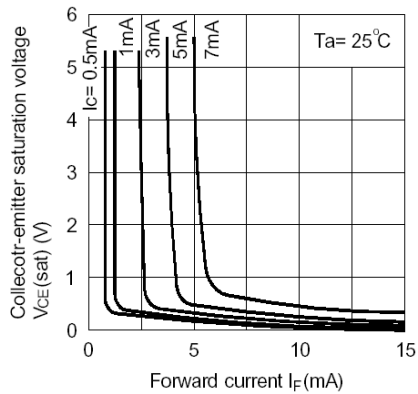

Fig.4 Forward Current vs. Forward Voltage

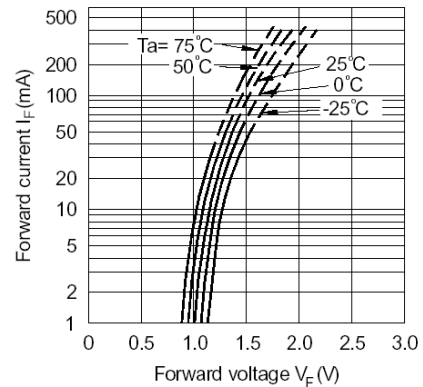

Fig.5 Current Transfer Ratio vs. Forward Current

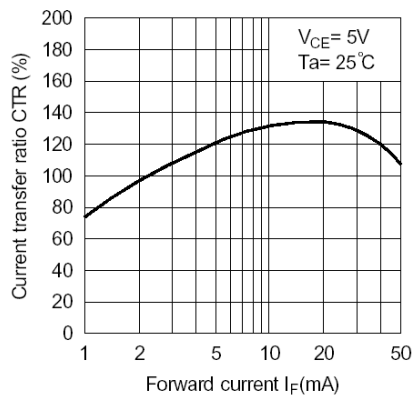
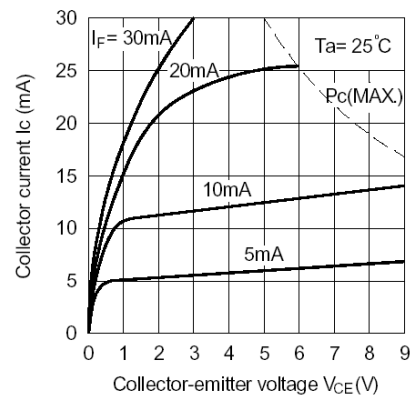

Fig.6 Collector Current vs. Collector-emitter Voltage



RATING AND CHARACTERISTIC CURVES (PC817)

Fig.1 Forward Current vs. Ambient Temperature

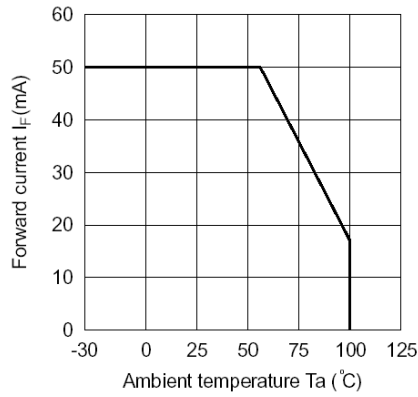

Fig.2 Collector Power Dissipation vs. Ambient Temperature

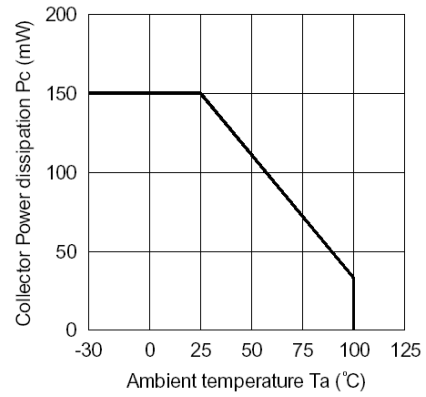

Fig.3 Collector-emitter Saturation Voltage vs. Forward Current

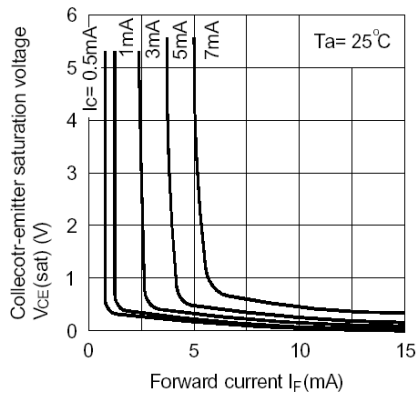

Fig.4 Forward Current vs. Forward Voltage

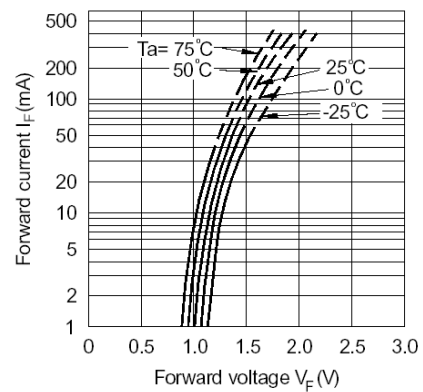

Fig.5 Current Transfer Ratio vs. Forward Current

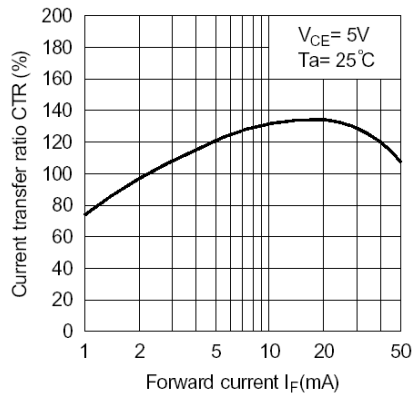
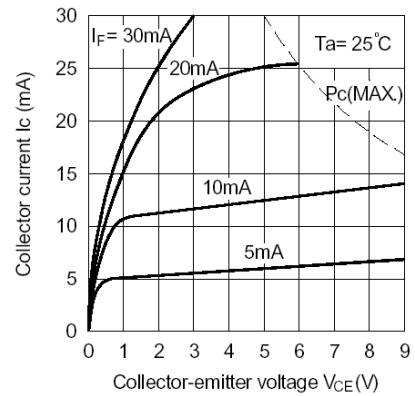

Fig.6 Collector Current vs. Collector-emitter Voltage



RATING AND CHARACTERISTIC CURVES (PC817)

Fig.7 Relative Current Transfer Ratio vs. Ambient Temperature

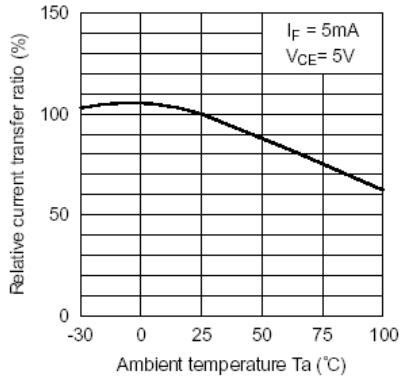

Fig.8 Collector-emitter Saturation Voltage vs. Ambient Temperature

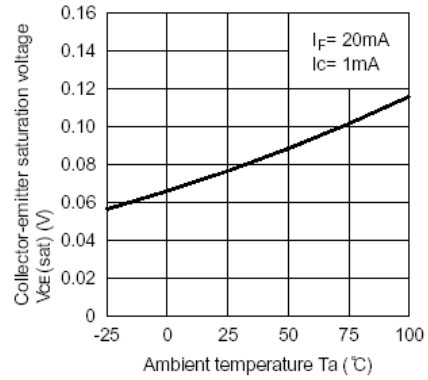

Fig.9 Collector Dark Current vs. Ambient Temperature

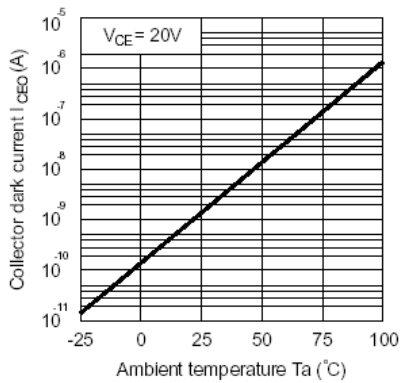

Fig.10 Response Time vs. Load Resistance

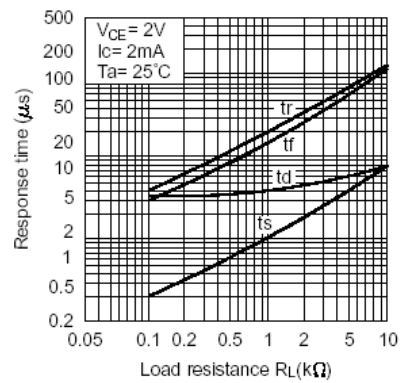
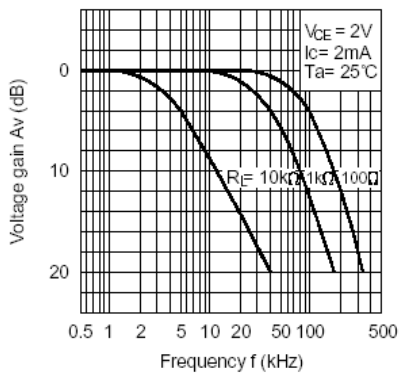
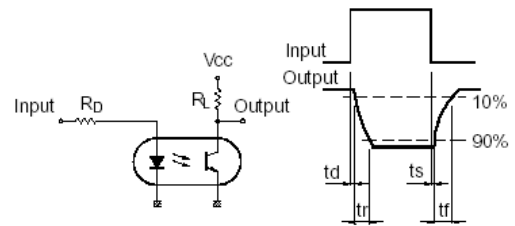

Fig.11 Frequency Response



Test Circuit for Response Time



Test Circuit for Frequency Response

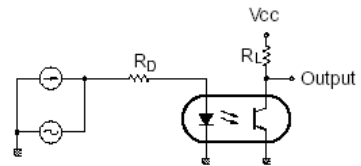

Outline Dimensions 外形尺寸

Unit: mm (inch)

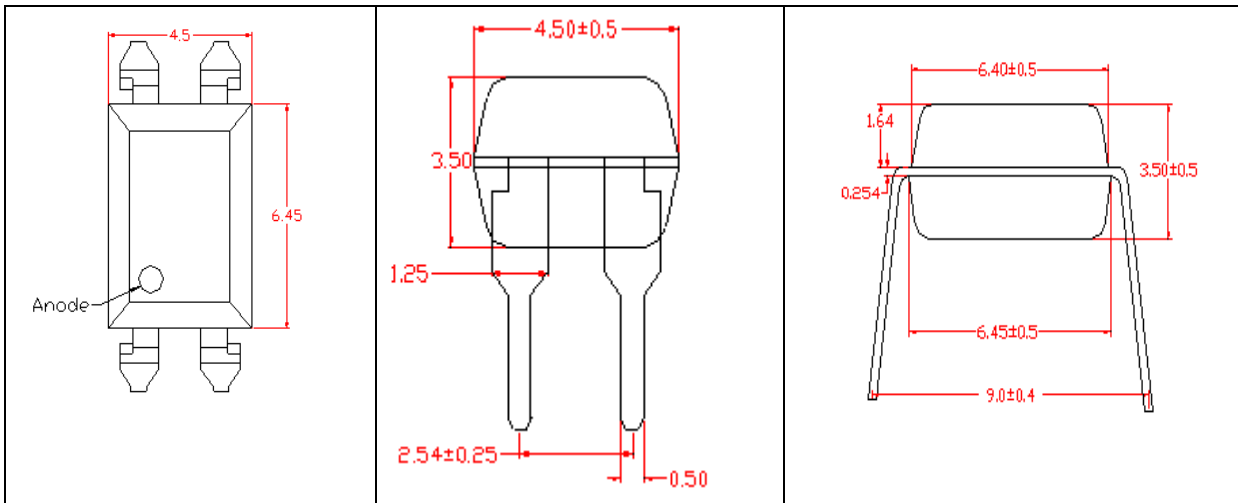

4-pin DIP

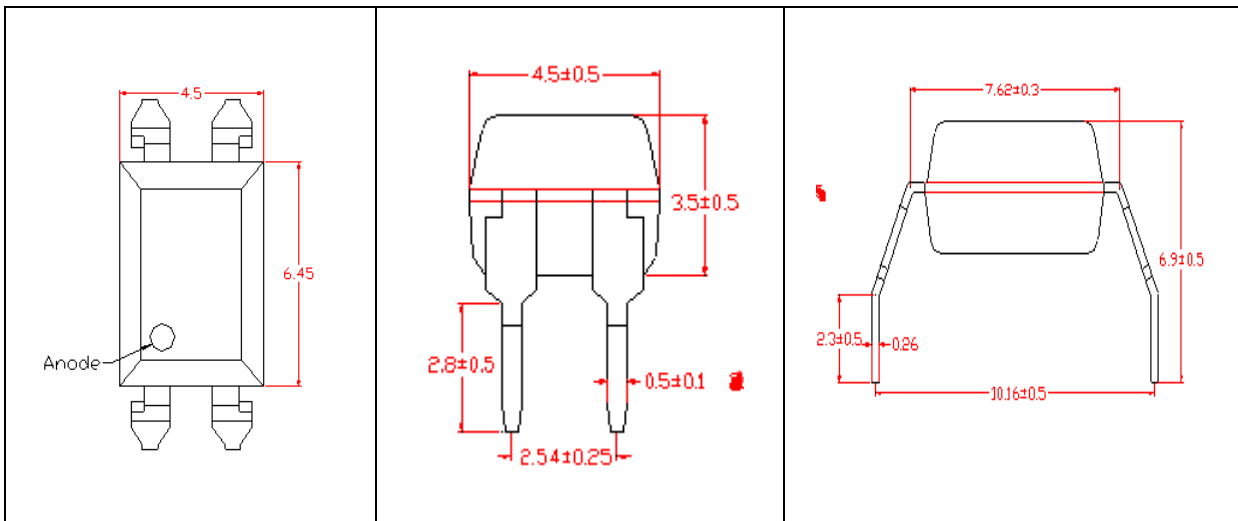

4-pin DIP (M Type)

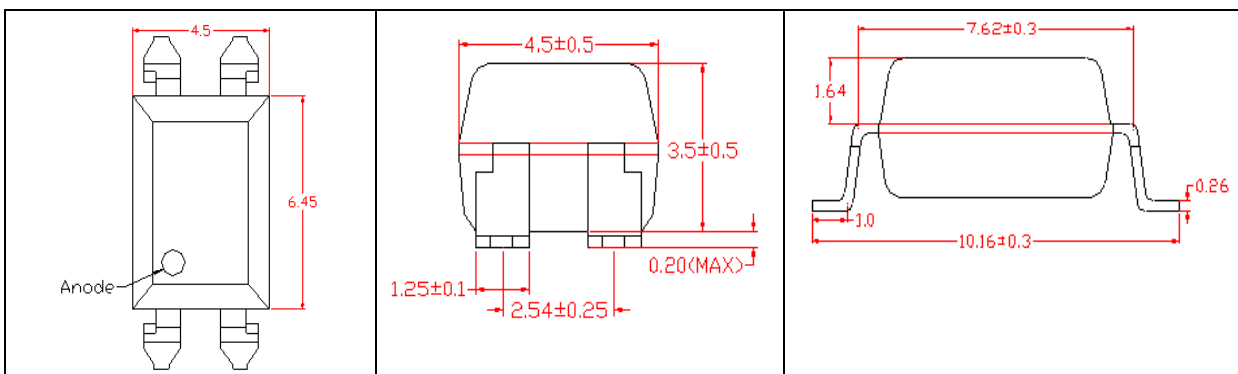

4-pin SMD