

IEI Riser Card

PCI Riser Card



PCIR-K01R-R10

1-slot PCI riser card
89.1 x 62.8 x 16 mm
PCI 2.2 standard with 32-bit 5V support

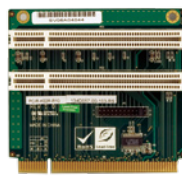
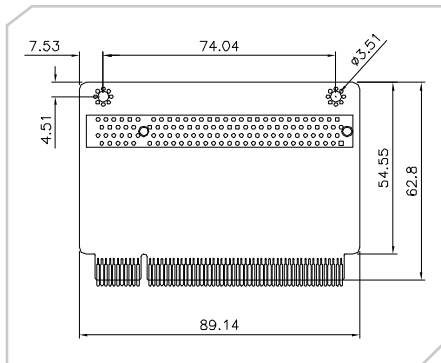

PCIR-K02R-R10

2-slot PCI riser card
89.1 x 83.1 x 16 mm
PCI 2.2 standard with 32-bit 5V support

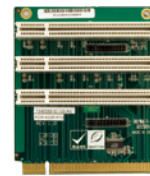
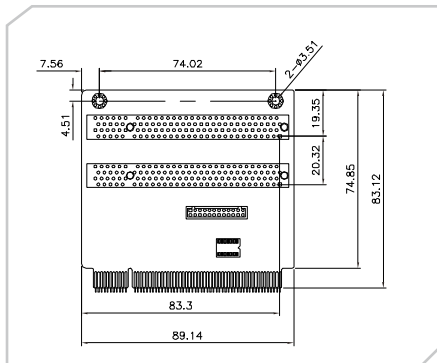

PCIR-K03R-R10

3-slot PCI riser card
89.1 x 103.4 x 16 mm
PCI 2.2 standard with 32-bit 5V support

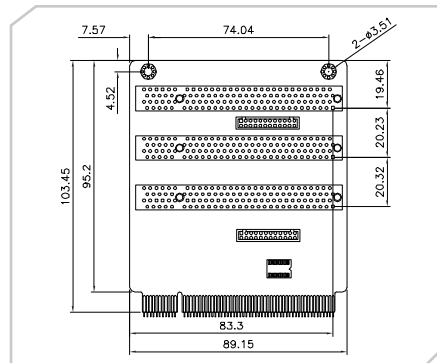

PCI Riser Card by Cable



PCIR-CB01R-R10

1-slot PCI riser card 18.5 x 111.9 mm

Packing list:

- 2 x PCI riser card connection cable
- 1 x 1-Slot PCI riser card
- 1 x Golden finger connection board
- 1 x QIG

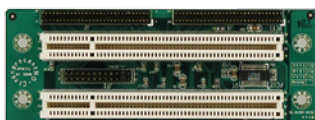
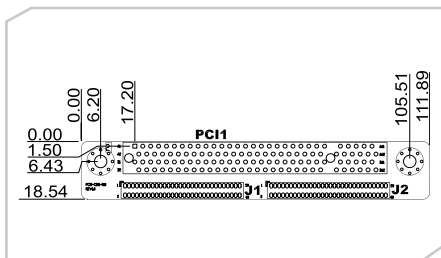

PCIR-CB02R-R10

2-slot PCI riser card 38.9 x 111.9 mm

Packing list:

- 2 x PCI riser card connection cable
- 1 x 2-Slot PCI riser card
- 1 x Golden finger connection board
- 1 x QIG

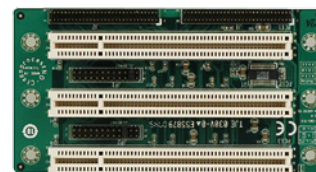
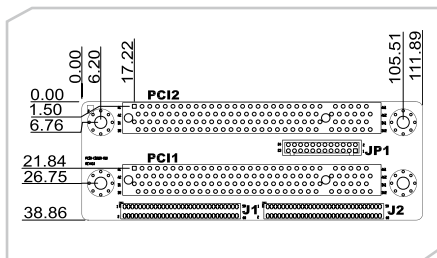

PCIR-CB03R-R10

3-slot PCI riser card 59.2 x 111.9 mm

Packing list:

- 2 x PCI riser card connection cable
- 1 x 3-Slot PCI riser card
- 1 x Golden finger connection board
- 1 x QIG

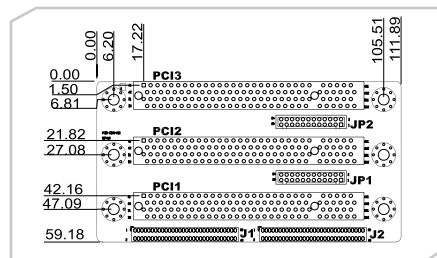

Compliant motherboard

PCIR-CB01R PCIR-K01R	PCIR-CB02R PCIR-K02R	PCIR-CB03R PCIR-K03R
<ul style="list-style-type: none"> IMBA/IMB series (Micro ATX/ ATX) KINO series (Mini-ITX) NOVA series (5.25" SBC) 	KINO-9652-R11 KINO-9453-R21	KINO-9652-R11 KINO-9453-R21

Golden finger connection board (PCIR-CB04GF-R10)

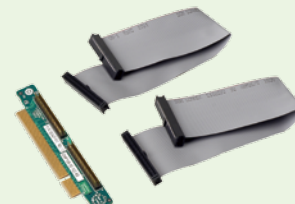
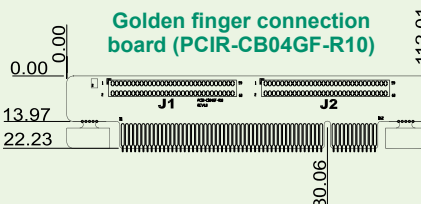

PCIER Riser Card

PCIe x1 Riser Card

PCIER-K101L-R10

Dimensions: 135x 31mm

Packing List

- 1 x PCIe x1 riser card
- 1 x QIG



Compatible model list KINO-PVN-D4251/D5251, KINO-PV-D4252/D5252