

■ Typical Specifications

Items	Specifications
Rating (max.)/(min.) (Resistive load)	1mA 5V DC / 50 $\mu$ A 3V DC
Contact resistance (Initial / After operating life)	200m $\Omega$ max. / 200m $\Omega$ max.
Rotational torque	13 $\pm$ 5mN·m
Operating life with load	10,000 cycles (1mA 5V DC)
Voltage proof	100V AC 1minute

■ Product Line

Poles	Positions	Changeover angle	Detent	Location lug	Changeover timing	Soldering	Actuator length (mm)	Minimum order unit (pcs.)		Product No.	Drawing No.
								Japan	Export		
1	10	36°	5	with	Non shorting	For PC board (Reflow)	1.7	1,200	4,800	<b>SRBD150201</b>	1
			7	without						<b>SRBD170401</b>	2
			8	with						<b>SRBD180201</b>	1
			10							<b>SRBD110401</b>	

■ Packing Specifications

Taping

Number of packages (pcs.)			Tape width (mm)	Export package measurements (mm)
1 reel	1 case /Japan	1 case /export packing		
1,200	2,400	4,800	24	428×413×172

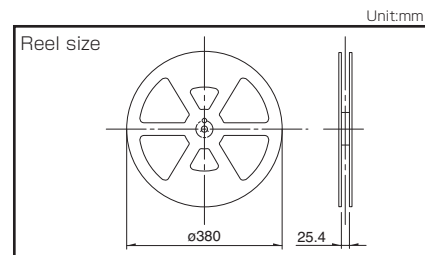

Detector  
Slide  
Push  
Rotary  
Power  
Dual-In-line Package Type

# SRBD Heavy-torque Feel, Low-profile Type

## Dimensions

Unit:mm

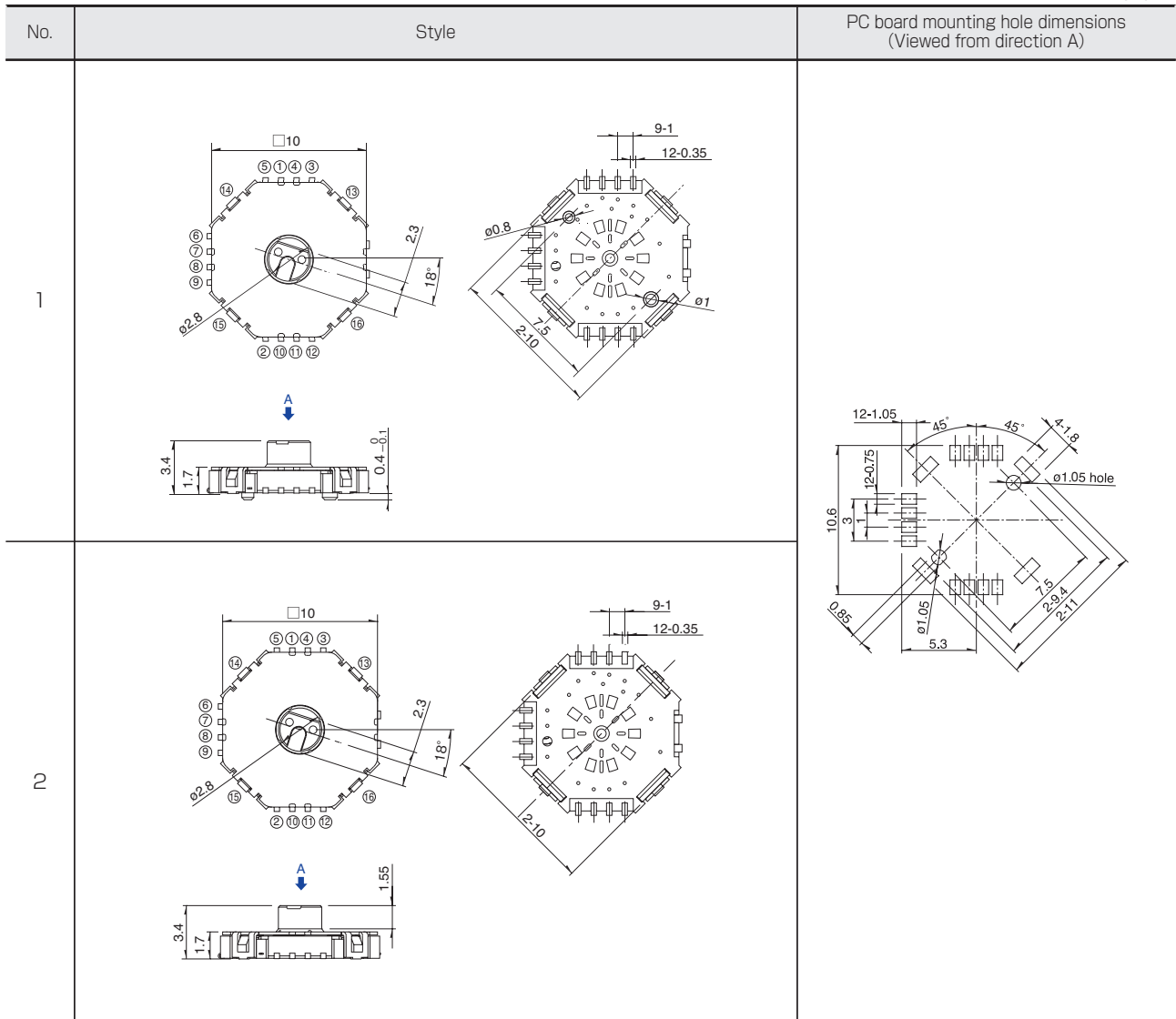

## Circuit Diagram (Viewed from Direction A)

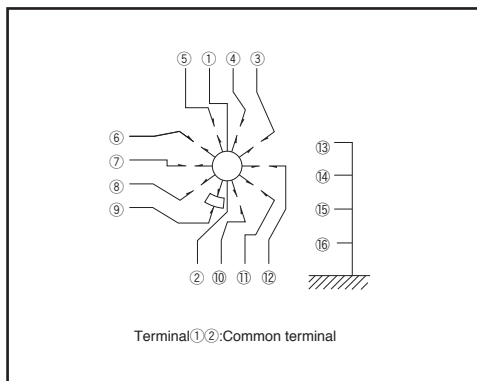













## Correspondence Table of Terminal No. and Detent

Position No.	Terminal No.	Detent			
		5	7	8	10
1	③	—	○	—	○
2	④	—	○	○	○
3	⑤	—	○	○	○
4	⑥	○	○	○	○
5	⑦	○	○	○	○
6	⑧	○	○	○	○
7	⑨	○	○	○	○
8	⑩	○	—	○	○
9	⑪	—	—	○	○
10	⑫	—	—	—	○

# Rotary Switches

## List of Varieties

Series	SRBD	SRBQ		SRBM		SRBV	SRRM	SRRN																																																
		Insertion	Reflow type	Rotary	Pulse																																																			
Photo																																																								
Angle of throw	36°	40±3°		30±3°	18±3°	30±3°																																																		
Number of poles	1		1, 2		1		1, 2, 3, 4	2, 3, 4																																																
Rotational torque	13±5mN·m	6±3mN·m 13±5mN·m		40±20mN·m 15±7mN·m		30±15mN·m	80±30mN·m (Shorting) 70±30mN·m (Non shorting)	70±30mN·m																																																
Dimensions (mm)	W	10	11.4		10		16.2																																																	
	D		12.4		12.5		18.5																																																	
	H		3.5		11		7.5																																																	
Operating temperature range	-25°C to +85°C	-10°C to +60°C		-30°C to +85°C		-10°C to +85°C	-10°C to +60°C	-30°C to +65°C																																																
Automotive use	—	—		—		—	—	—																																																
Life cycle																																																								
Rating (max.)/(min.) (Resistive load)	1mA 5V DC 50µA 3V DC	0.1A 16V DC 50µA 3V DC				0.3A 16V DC 50µA 3V DC		0.25A 30V DC 50µA 3V DC	0.15A 12V DC 50µA 3V DC																																															
Durability	Operating life without load	10,000 cycles 250mΩ max.	10,000 cycles 100mΩ max.		30,000 cycles 100mΩ max.		10,000 cycles 100mΩ max.	10,000 cycles 40mΩ max.	10,000 cycles 70mΩ max.																																															
	Operating life with load Load: as rating	10,000 cycles 250mΩ max.	10,000 cycles 100mΩ max.	10,000 cycles 150mΩ max.			10,000 cycles 60mΩ max.	10,000 cycles 100mΩ max.																																																
Electrical performance	Initial contact resistance	200mΩ max.	50mΩ max.				20mΩ max.	50mΩ max.																																																
	Insulation resistance	100MΩ min. 100V DC					100MΩ min. 500V DC																																																	
	Voltage proof	100V AC for 1minute					500V AC for 1minute																																																	
Mechanical performance	Terminal strength	3N for 1minute	5N for 1minute				10N for 1minute	5N for 1minute																																																
	Actuator strength	Operating direction	—	—	0.5N·m	—	0.6N·m	1N·m																																																
		Pulling direction	50N	20N	100N																																																			
	Wobble of actuator	Load at the tip of shaft SRRM, SRBM, SRRN: 5N, SRBQ, SRBV: 1N The below table shows for SRRM, SRBM, SRRN      The below table shows for SRBQ      The below table shows for SRBV																																																						
<table border="1" style="width: 100%; border-collapse: collapse;"> <thead> <tr> <th>Measuring position from mounting surface</th> <th>Shaft wobble (max. value)</th> <th>Applicable mounting dimension</th> <th>Distance from mounting surface to the tip of shaft</th> <th>Shaft wobble (max. value)</th> <th>Measuring position from mounting surface</th> <th>Shaft wobble (max. value)</th> <th>Applicable mounting dimension</th> </tr> </thead> <tbody> <tr> <td>10</td> <td>0.17</td> <td>15</td> <td>below 5</td> <td>0.5</td> <td>10</td> <td>0.2</td> <td>15</td> </tr> <tr> <td>15</td> <td>0.25</td> <td>20</td> <td>above 5 and below 10</td> <td>0.9</td> <td>15</td> <td>0.3</td> <td>20</td> </tr> <tr> <td>20</td> <td>0.35</td> <td>25</td> <td>above 10 and below 15</td> <td>1.2</td> <td>20</td> <td>0.4</td> <td>25</td> </tr> <tr> <td>25</td> <td>0.42</td> <td>30</td> <td></td> <td></td> <td></td> <td></td> <td></td> </tr> <tr> <td>30</td> <td>0.5</td> <td>above 35</td> <td></td> <td></td> <td></td> <td></td> <td></td> </tr> </tbody> </table> <p style="text-align: right;">Unit:mm</p>									Measuring position from mounting surface	Shaft wobble (max. value)	Applicable mounting dimension	Distance from mounting surface to the tip of shaft	Shaft wobble (max. value)	Measuring position from mounting surface	Shaft wobble (max. value)	Applicable mounting dimension	10	0.17	15	below 5	0.5	10	0.2	15	15	0.25	20	above 5 and below 10	0.9	15	0.3	20	20	0.35	25	above 10 and below 15	1.2	20	0.4	25	25	0.42	30						30	0.5	above 35					
Measuring position from mounting surface	Shaft wobble (max. value)	Applicable mounting dimension	Distance from mounting surface to the tip of shaft	Shaft wobble (max. value)	Measuring position from mounting surface	Shaft wobble (max. value)	Applicable mounting dimension																																																	
10	0.17	15	below 5	0.5	10	0.2	15																																																	
15	0.25	20	above 5 and below 10	0.9	15	0.3	20																																																	
20	0.35	25	above 10 and below 15	1.2	20	0.4	25																																																	
25	0.42	30																																																						
30	0.5	above 35																																																						
Environmental performance	Cold	-40°C 500h	-20°C 96h	-40°C 96h		-20°C 96h		-40°C 96h																																																
	Dry heat	85°C 500h	85°C 96h																																																					
	Damp heat	60°C, 90 to 95%RH 500h	40°C, 90 to 95%RH 96h																																																					
Page	143	145	147	150	152	155																																																		

Rotary Switches Soldering Conditions . . . . . 158  
 Rotary Switches Cautions . . . . . 159

# Rotary Switches Soldering Conditions

## Example of Reflow Soldering Condition

1. Heating method: Double heating method with infrared heater.
2. Temperature measurement: Thermocouple  $\phi 0.1$  to  $0.2$  CA (K) or CC (T) at soldering portion (copper foil surface). A heat resisting tape should be used for fixed measurement.
3. Temperature profile

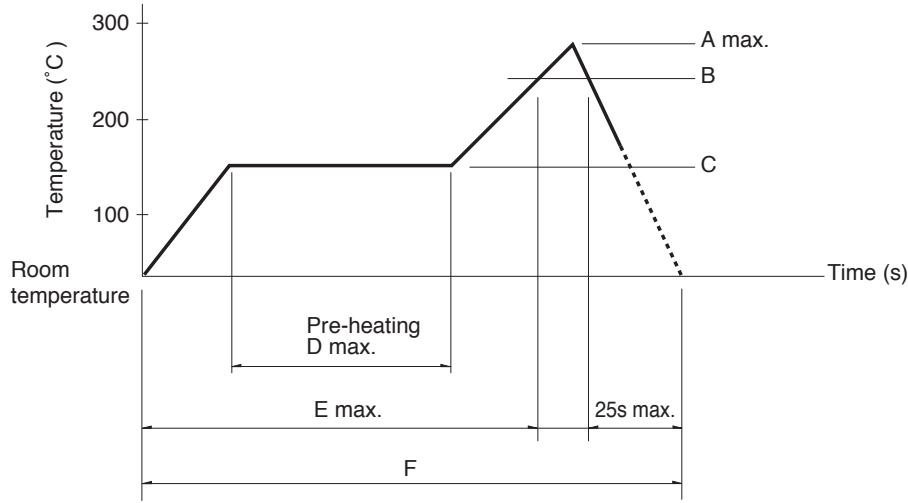

Series (Reflow type)	A (°C) 3s max.	B (°C)	C (°C)	D (s)	E (s)	F (s)
<b>SRBQ</b>	250	200	150±5	80 to 100	—	—

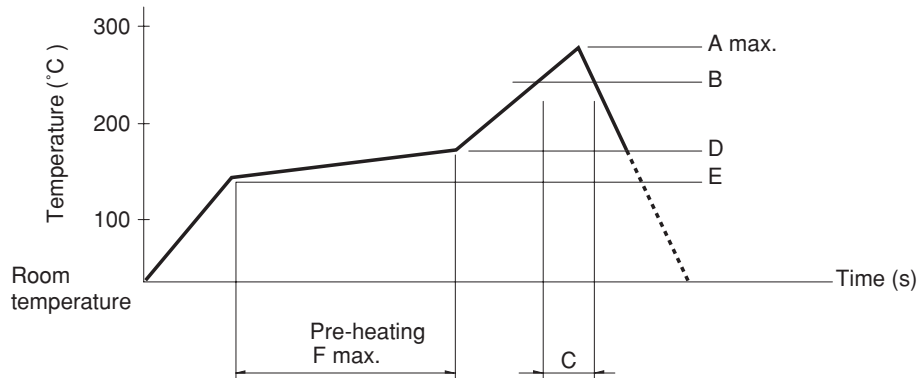

Series (Reflow type)	A (°C) 3s max.	B (°C)	C (s)	D (°C)	E (°C)	F (s)
<b>SRBD</b>	260	230	40	180	150	120

- Notes**
1. The condition mentioned above is the temperature on the mounting surface of a PC board. There are cases where the PC board's temperature greatly differs from that of the switch, depending on the PC board's material, size, thickness, etc. The above-stated conditions shall also apply to switch surface temperatures.
  2. Soldering conditions differ depending on reflow soldering machines. Prior verification of soldering condition is highly recommended.

## Reference for Hand Soldering

Series	Soldering temperature	Soldering time
<b>SRBQ, SRBM, SRBV, SRRM, SRRN</b>	350±10°C	3+1/0s
<b>SRBQ (Reflow type)</b>	350±5°C	3s max.

## Reference for Dip Soldering

(For PC board terminal types)

Series	Items		Dip soldering	
	Preheating temperature	Preheating time	Soldering temperature	Duration of immersion
<b>SRBM</b>	100°C max.	60s max.	260±5°C	5s max.
<b>SRBV, SRRM, SRRN</b>	—	—	260±5°C	10±1s
<b>SRBQ</b>	—	—	260±5°C	5±1s

# Mouser Electronics

Authorized Distributor

Click to View Pricing, Inventory, Delivery & Lifecycle Information:

ALPS:

[SRBD170401](#) [SRBD150201](#) [SRBD110401](#) [SRBD180201](#)