

SMP Coaxial Connectors MIL Standard Compliant

SMP Series



■ Features

1. Excellent High Frequency performance
2. Easy push-on lock
3. Wide variations
4. MIL Standard compliant (MIL-STD-348B)
5. RoHS2 compliant
6. Halogen-free

■ Applications

Optical transmission devices,
Data transmission measurement,
Radio communication equipment,
Measuring instruments etc.

■ Functional diagram

Plug side

- Straight plug receptacle
SMP-PR(**)-SMT-1



- Right angle plug receptacle
SMP-LPR(**)-SMT-1



- Conversion adapter (SMP plug to 2.92mm plug)
SMPP(**)-HKP



Jack side

- Jack
SMP-J-SF085



- Right angle jack
SMP-LJ-SF085



- Relay adapter (Jack to Jack)
SMP-A-JJ-645



- Conversion adapter (SMP jack to 2.92mm jack)
SMPJ-HKJ



- Terminator
SMP-TMJ



Product Specifications

Ratings	Nominal characteristic impedance	50Ω	Operating Temperature Range	-55°C to +125°C (95% RH or less)
	Frequency range	0 to 30GHz	Storage Temperature Range	-55°C to +50°C (95% RH or less)

Items	Specifications	Conditions
1. Contact resistance	Center : Not greater than 6mΩ External : Not greater than 6mΩ	Measured at 100mA or below
2. Insulation resistance	Not greater than 1,000MΩ	Measured at 500V DC
3. Withstanding voltage	No flashover or breakdown	500V AC for 1 minute
4. Voltage standing wave ratio	● SMP-J-SF085 VSWR : Not greater than 1.3 (0 to 15GHz) VSWR : Not greater than 1.5 (15 to 30GHz)	● SMP-PR (**)-SMT VSWR : Not greater than 1.5 (0 to 30GHz)
5. Holding power of female contact	Not less than 0.2N	Measured with φ0.35 pin gauge
6. Mating Cycles	Contact resistance at center : Not greater than 12mΩ External : Not greater than 12mΩ No broken, cracked, or loose parts	500 cycles
7. Moisture resistance of temperature/humidity cycle	Insulation resistance : Not less than 100MΩ (in a high humidity environment) Insulation resistance : Not less than 1,000MΩ (in a dry environment) No broken, cracked or loose parts	Left for 10 cycles (240 hours) in an environment with the temperature ranging from -10 to 65°C and the humidity ranging from 90 to 98%.
8. Temperature cycle	No broken, cracked or loose parts	5 cycles of the following series of test condition : Temperature : -65°C → - → +125°C → - Time period : 30 min. → 3 min. → 30 min. → 3 min.
9. Salt spray	No considerable corrosion	Continuous 48 hour cycle in 5% salt water solution

*Measurement of voltage standing wave ratio (VSWR)

The specified values of VSWR noted above, are taken with the test set up shown in the figure below:

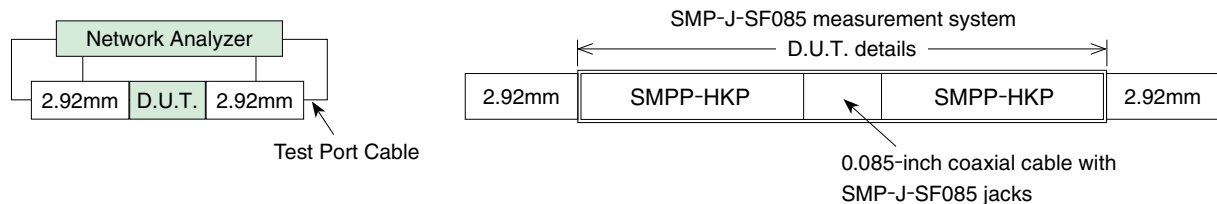

Materials / Finish

Part		Materials	Finish
Shell	Jack	Beryllium copper	Gold plated
	Plug	Brass, Stainless steel	Gold plated, Passivated
Contact	Male contact	Phosphor bronze	Gold plated
	Female contact	Beryllium copper	Gold plated
Insulator		LCP, PTFE resin	—

Product Number Structure

Refer to the below chart of the product number when determining the product specifications.

Please select from the product numbers listed below when placing orders.

SMP - [] - []

① ② ③

① Series name : SMP
② Connector type J : Straight jack LJ : Right angle jack PR : Straight plug receptacle LPR : Right angle plug receptacle A-JJ : Relay adapter
③ Applicable cable SF085 : 0.085-inch coaxial cable SMT : PCB surface mount type 645 : 6.45mm

*Please contact Hirose for cable assembly specifications.

■ Straight jack (0 to 30GHz)

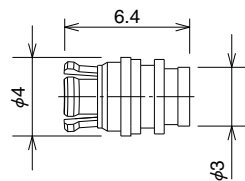

Part No.	HRS No.
SMP-J-SF085	338-1100-0

■ Right angle jack (0 to 30GHz)

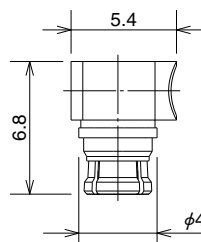

Part No.	HRS No.
SMP-LJ-SF085	338-1101-0

■ Straight plug receptacle (0 to 30GHz)

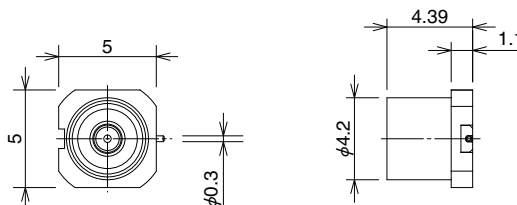

Part No.	HRS No.
SMP-PR(FD)-SMT-1	338-1102-0
SMP-PR(LD)-SMT-1	338-1103-0
SMP-PR(SB)-SMT-1	338-1104-0

■ Right angle plug receptacle (0 to 30GHz)

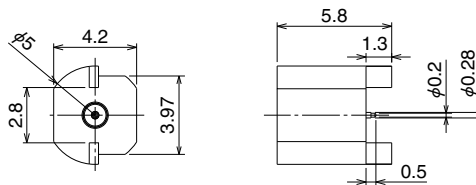

Part No.	HRS No.
SMP-LPR(FD)-SMT-1	338-1105-0
SMP-LPR(LD)-SMT-1	338-1107-0
SMP-LPR(SB)-SMT-1	338-1108-0

Note : Insertion / Extraction Force
 FD : FULL DETENT
 LD : LIMITED DETENT
 SB : SMOOTH BORE

Sep. 1. 2024 Copyright 2024 HIROSE ELECTRIC CO., LTD. All Rights Reserved.

■ Relay adapter (Jack to Jack) (0 to 40GHz)

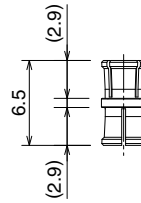

Part No.	HRS No.
SMP-A-JJ-645	338-1106-0

■ Conversion adapter

● SMP jack to 2.92mm jack (0 to 40GHz)

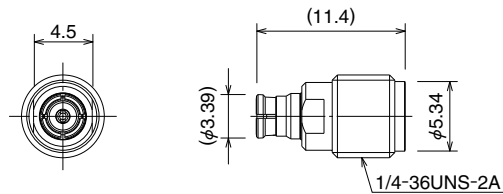

Part No.	HRS No.
SMPJ-HKJ	311-0013-0

● SMP plug to 2.92mm plug (0 to 40GHz)

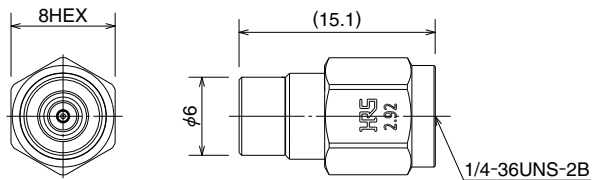

Part No.	HRS No.
SMPP(FD)-HKP	311-0199-0
SMPP(SB)-HKP	311-1001-0

Note : Insertion / Extraction Force
 FD : FULL DETENT
 LD : LIMITED DETENT
 SB : SMOOTH BORE

●SMA conversion adapter launcher type (SMP jack to SMA jack) (0 to 18GHz)

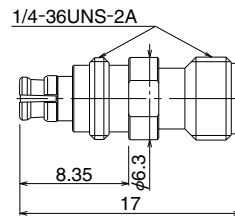

Part No.	HRS No.
HRMJ-SMPJ-BPA-18G	311-0001-0

●SMA conversion adapter (SMP jack to SMA jack) (0 to 18GHz)

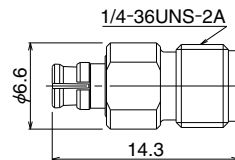

Part No.	HRS No.
HRMJ-SMPJ-18G	311-0002-0

●SMA conversion adapter (SMP plug to SMA plug) (0 to 18GHz)

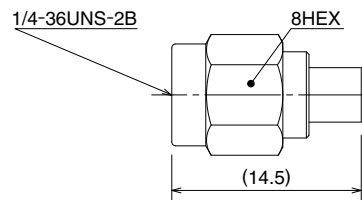

Part No.	HRS No.
HRMP-SMPP-18G	311-0006-0

■ Nonreflective terminator
 ■ Product Specifications

Ratings	Nominal characteristic impedance	50Ω	Operating Temperature Range	-40°C to +85°C
	Rated frequency	DC to 30GHz		
	Power	0.25W CW (+65°C)	Operating relative humidity	95% RH or less

■ Materials / Finish

Part	Materials	Finish
Shell	Body : Brass	Gold plated
	Spring Part : Beryllium copper	
Insulator	PTFE	—
Female contact	Beryllium copper	Gold plated
Resistive element	Metal film	—

■ Product Number Structure

SMP - TM J

① ② ③

① Series name	SMP
② TM	Non-reflective terminator
③ Connector type	J : Jack type

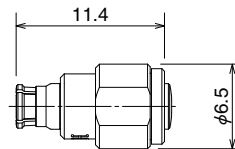

Part No.	HRS No.	Voltage standing wave ratio (V.S.W.R.)(max)		
		DC to 15GHz	15 to 25GHz	25 to 30GHz
SMP-TMJ	353-0024-0	1.15	1.2	1.25

Sep. 1. 2024 Copyright 2024 HIROSE ELECTRIC CO., LTD. All Rights Reserved.

◆ Frequency characteristics (TYPICAL)

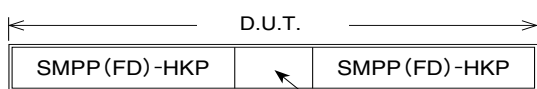
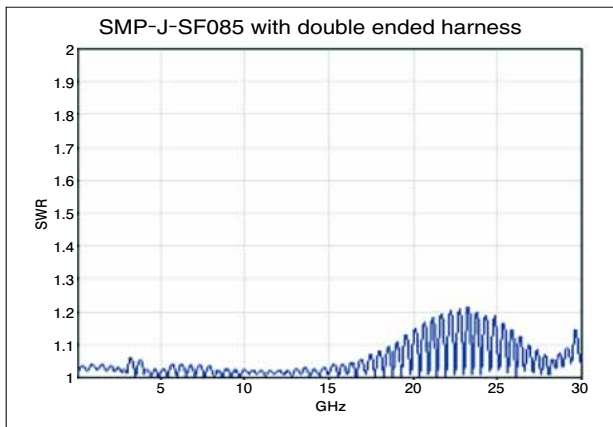

SMP-J-SF085 with double ended harness

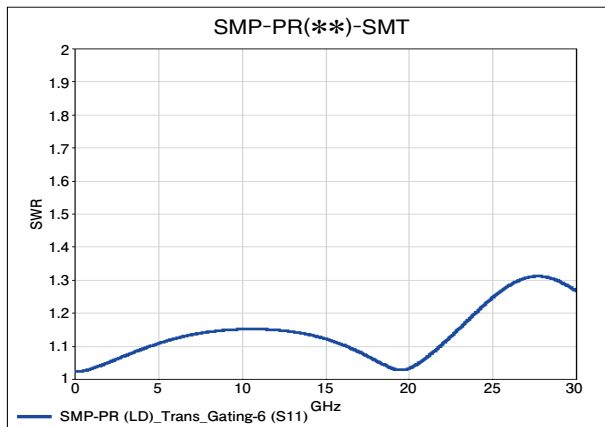

※This data does not include part of micro strip line and 2.92 end launch connector installed on test board by using gating function of vector network analyzer.

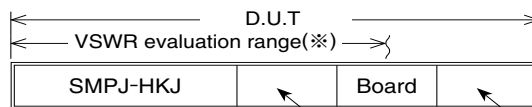

SMP-PR(**)-SMT 2.92 End Launch

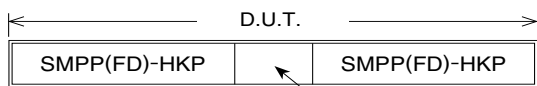
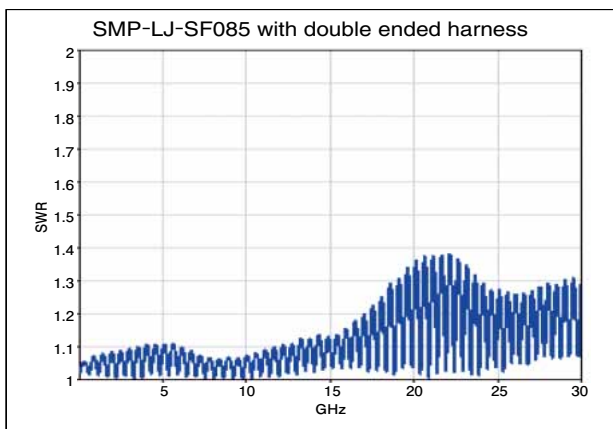

SMP-LJ-SF085 with double ended harness

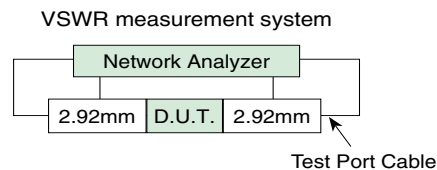

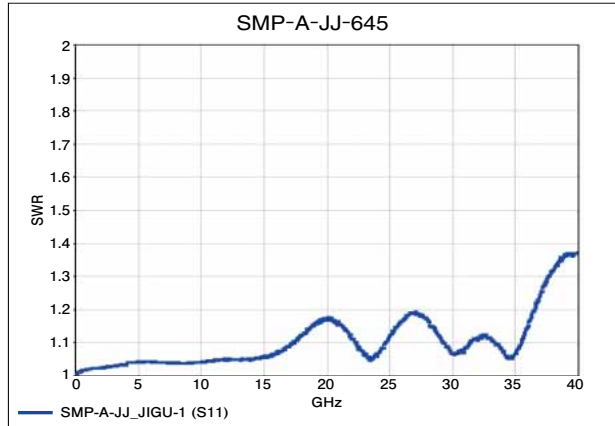
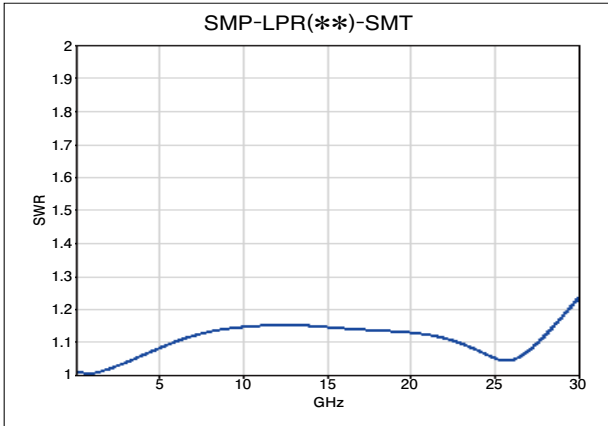

※ This data does not include part of micro strip line and 2.92 end launch connector installed on test board by using gating function of vector network analyzer.

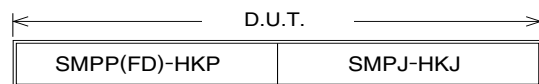
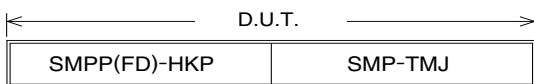
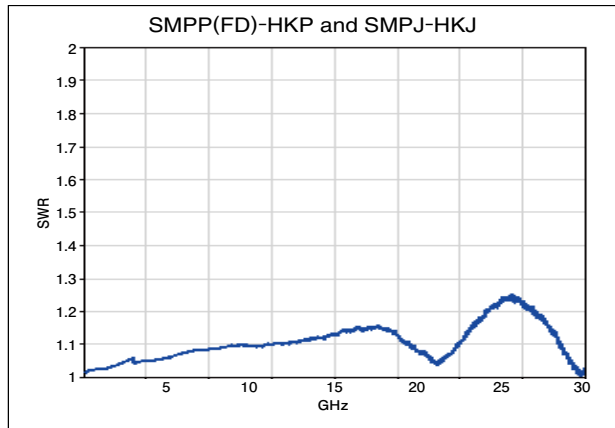
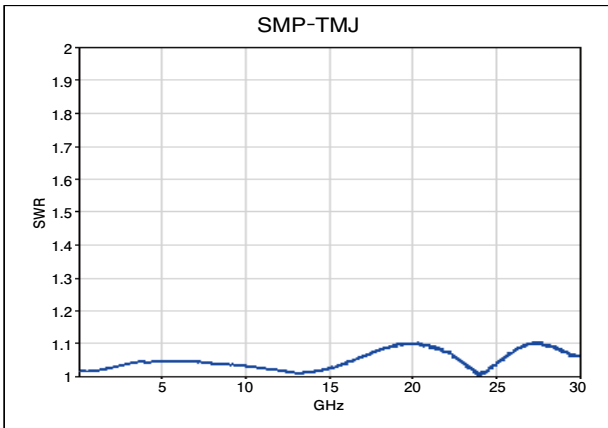
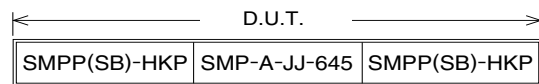
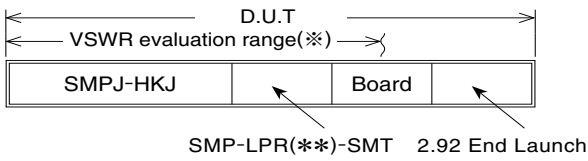

Sep. 1. 2024 Copyright 2024 HIROSE ELECTRIC CO., LTD. All Rights Reserved.

◆ Mated dimensions (FD, LD, SB)

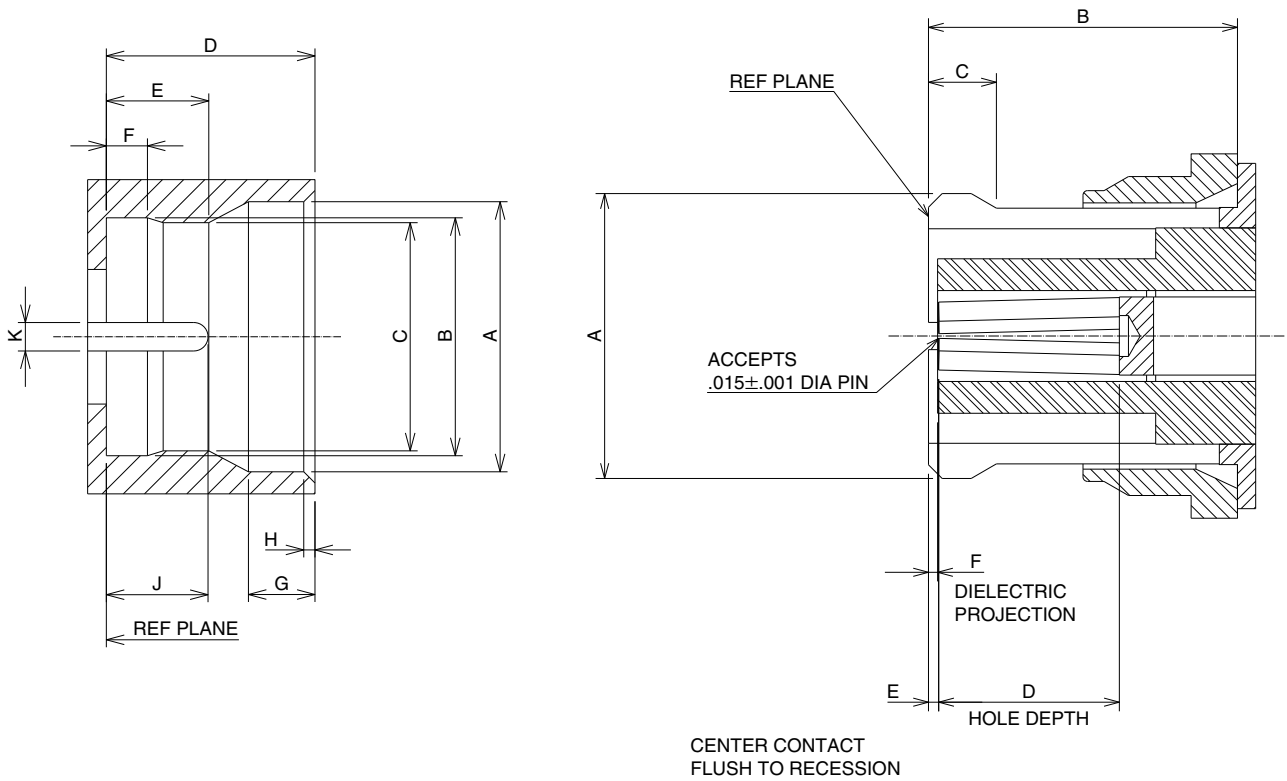

	PLUG						JACK	
	Inches(mm)							
	Full detent		Limited detent		Smooth bore		min	max
	min	max	min	max	min	max		
A	φ.139(3.53)	φ.145(3.68)	φ.139(3.53)	φ.145(3.68)	φ.139(3.53)	φ.145(3.68)	—	φ.135(3.43)
B	φ.124(3.15)	φ.126(3.20)	φ.124(3.15)	φ.126(3.20)	φ.123(3.12)	φ.127(3.23)	.112(2.84)	—
C	φ.114(2.90)	φ.118(3.00)	φ.118(3.00)	φ.122(3.10)	—	—	.018(0.46)	.025(0.64)
D	.108(2.74)	.112(2.84)	.108(2.74)	.112(2.84)	.108(2.74)	.112(2.84)	.070(1.78)	—
E	.051(1.30)	.057(1.45)	.054(1.37)	.060(1.52)	.059(1.50)	.065(1.65)	.008(0.20)	
F	.0205(0.521)	.0235(0.597)	.0205(0.521)	.0235(0.597)	—	—	.000(0.00)	
G	.033(0.84)	.037(0.94)	.033(0.84)	.037(0.94)	.033(0.84)	.037(0.94)	—	—
H	.003(0.08)	.008(0.02)	.003(0.08)	.008(0.02)	.003(0.08)	.008(0.02)	—	—
J	.045(1.14)	.055(1.40)	.045(1.14)	.055(1.40)	.045(1.14)	.055(1.40)	—	—
K	.014(0.36)	.016(0.41)	.014(0.36)	.016(0.41)	.014(0.36)	.016(0.41)	—	—

Note : Insertion / Extraction Force
 FD : FULL DETENT
 LD : LIMITED DETENT
 SB : SMOOTH BORE

◆ Connector extraction tools

Extraction tools have been released for jack products of SMP series.

Part No.	Applicable tool	HRS No.	Reference
SMP-LJ-***	SMP-J-N1	350-0014-0	Fig. ①
SMP-J-***	SMP-J-N1	350-0014-0	Fig. ②
	SMP-J-N2	350-0015-0	

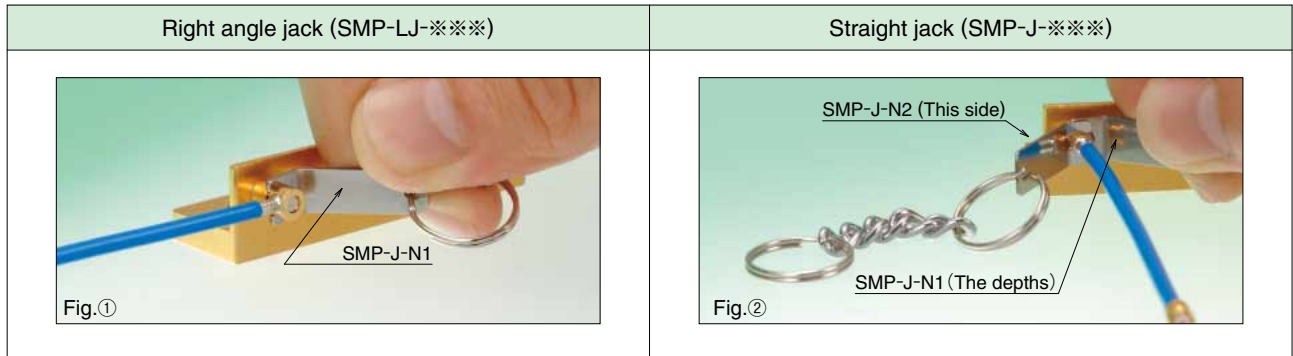

Note 1 : The tools can release the lock. After releasing the lock, please hold connector body and pull out.

Note 2 : These extraction tools are designed for SMP series only.

MEMO :

Area with horizontal dashed lines for writing.

MEMO :

Area with horizontal dashed lines for writing.

HIROSE ELECTRIC CO.,LTD.

2-6-3,Nakagawa Chuoh,Tsuzuki-Ku,Yokohama-Shi 224-8540,JAPAN

<https://www.hirose.com/>
