

# K-LD7

## digital radar transceiver

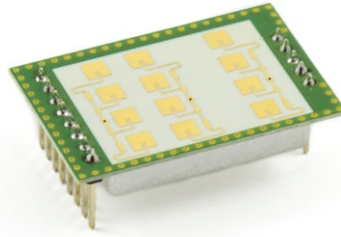

### Features

- Small and low cost digital 24 GHz radar motion detector
- Measures speed, direction, distance and angle of moving objects
- Low current consumption
- Typical detection distance: 15 m for persons/30 m for cars
- Target list output over serial interface
- Integrated FFT signal processing with tracking
- 4 configurable digital outputs
- Power supply range from 3.2 to 5.5 V
- 3x4 patch antenna with 80°/34° beam aperture

### Applications

- Distance triggered movement detection applications
- Simple gesture recognition
- Indoor and outdoor lighting control applications
- Pedestrian counting
- Traffic counting

### Description

The K-LD7 is a fully digital low cost Doppler radar that can measure speed, direction, distance and angle of moving objects in front of the sensor. The digital structure and wide power supply range make it very easy to use this sensor in any stand-alone or MCU based application.

The sensor includes a 3x4 patch antenna radar front-end with an asymmetrical beam and a powerful signal processing unit with four configurable digital outputs for signal detection information. A built-in tracking filter makes the sensor output even easier to use. The serial interface features the possibility to read out a target list with speed, direction, distance and angle information of all moving objects in front of the sensor or to digitally configure the sensors detection parameters.

There is no need to write own signal processing algorithms or handle small and noisy signals. This module contains everything what is necessary to build a simple but powerful motion detector with distance and angle information. A very small footprint of 38x25x13.5 mm gives maximum flexibility in the product development process. For fast prototyping an evaluation kit (K-LD7-EVAL) is available which features powerful signal visualization on a PC.

### Block Diagram

Figure 1: Block diagram

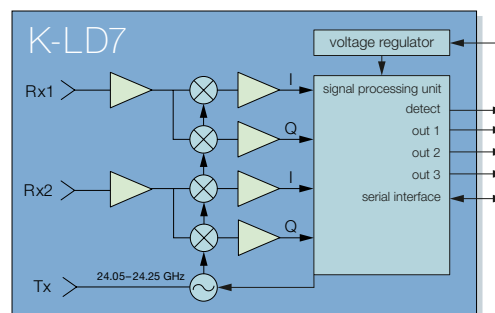

# Characteristics

Parameter	Conditions/Notes	Symbol	Min	Typ	Max	Unit
-----------	------------------	--------	-----	-----	-----	------

## Operating Conditions

Supply voltage		$V_{CC}$	3.2		5.5	V
Supply current	Depending on speed range setting	$I_{CC}$	25		60	mA
Peak current	At start-up	$I_{PP}$		160	200	mA
Operating temperature		$T_{Op}$	-20		+85	°C
Storage temperature		$T_{St}$	-40		+105	°C

## Transmitter

Transmitter frequency	$T_{amb} = -20^{\circ}\text{C} \dots +85^{\circ}\text{C}$	$f_{TX}$	24.050		24.250	GHz
Output power	EIRP	$P_{TX}$		6		dBm
Spurious emissions	According to ETSI 300 440	$P_{spur}$			-30	dBm

## Receiver

LNA gain		$G_{LNA}$		19		dB
Mixer conversion loss	$f_{IF} = 1\text{kHz}$	$D_{mixer}$		10		dB
Antenna gain	$f_{TX} = 24.15\text{GHz}$	$G_{Ant}$		8.6		dB
Receiver sensitivity	$f_{IF} = 500\text{Hz}, B = 1\text{kHz}, S/N = 6\text{dB}$	$P_{RX}$		-112		dBm
Overall sensitivity	$f_{IF} = 500\text{Hz}, B = 1\text{kHz}, S/N = 6\text{dB}$	$D_{system}$		-127		dBc
Detection distance	$\sigma = 1\text{m}^2$ (Person)	R		15		m

## Signal Processing

Modulation			FSK			
Velocity processing			256 point complex FFT			
Speed range	Max value adjustable	$r_{speed}$	0.1		100	km/h
Speed resolution	Depending on speed range setting	$\Delta r_{speed}$	0.1		0.8	km/h
Distance range	Max value adjustable	$r_{distance}$	0.005		100	m
Distance resolution	Depending on distance range setting	$\Delta r_{distance}$	5		100	cm
Angular resolution		$\Delta r_{angle}$		1		deg
Tracking range	Limited to one target	$r_{tracking}$	0.005		30	m

## Antenna

Horizontal -3dB beam width	E-Plane	$W_{\phi}$		80		°
Vertical -3dB beam width	H-Plane	$W_{\theta}$		34		°
Horiz. side lobe suppression		$D_{\phi}$	-12	-20		dB
Vertical side lobe suppression		$D_{\theta}$	-12	-20		dB
Rx1/Rx2 spacing		l		6.223		mm

## Interface

Digital output high level voltage		$V_{OH@8mA}$	2.4		3	V
Digital output low level voltage		$V_{OL@8mA}$	0		0.4	V
Digital output high level voltage		$V_{OH@20mA}$	1.7		3	V
Digital output low level voltage		$V_{OL@20mA}$	0		1.3	V
Digital input high level voltage		$V_{IH}$	1.7		4	V
Digital input low level voltage		$V_{IL}$	-0.3		1.3	V
Digital I/O source/sink current		$I_{OH}, I_{OL}$	-20		20	mA

## Body

Outline dimensions				37×25×13.5		mm <sup>3</sup>
Weight				5		g
Connector				3pin 2.54mm / 8pin 2.54mm		

---

# TABLE OF CONTENTS

Product Information .....	1
Features .....	1
Applications .....	1
Description .....	1
Block Diagram .....	1
Characteristics .....	2
Antenna Diagram Characteristics .....	4
Pin Configuration and Functions .....	4
Theory of Operation .....	5
Overview .....	5
Processing .....	5
Speed and direction measurement .....	6
Distance measurement .....	6
Angle measurement .....	6
Raw targets and tracking filter .....	7
Micro detection .....	7
Application Information .....	8
Stand-alone operation .....	8
Host driven operation .....	8
Radar settings .....	9
Detection settings .....	11
Instruction Set Description .....	13
Hardware Layer .....	13
Application Layer .....	13
Presentation Layer .....	15
Outline Dimensions .....	19
Order Information .....	19
Revision History .....	19

# ANTENNA DIAGRAM CHARACTERISTICS

This diagram shows module sensitivity in both azimuth and elevation directions. It incorporates the transmitter and receiver antenna characteristics.

**Figure 2: Antenna characteristics**

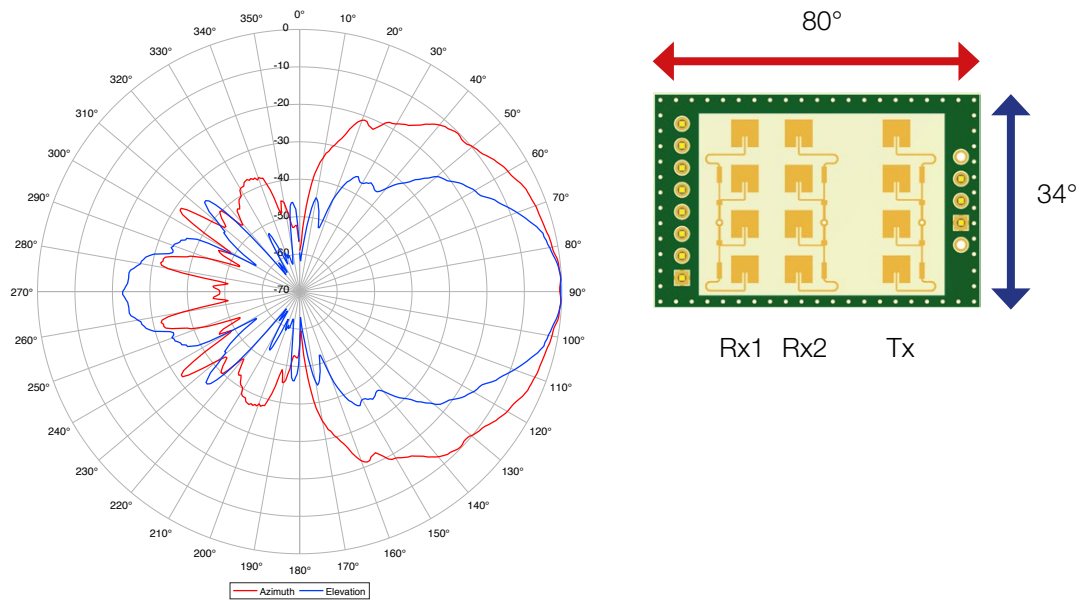

# PIN CONFIGURATION AND FUNCTIONS

**Figure 3: Pin configuration**

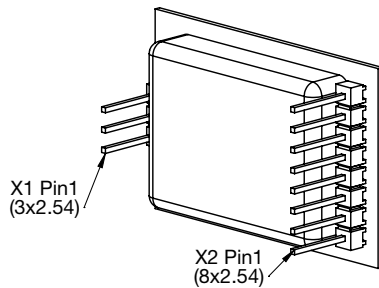

**Table 1: Pin function description**

Connector	Pin. No.	Name	Description	
X1	1-3	Mounting	These pins are for mounting only. ⚠ Leave this pins floating and do not connect them to any potential.	
	X2	1	GND	Ground pin
		2	Digital out 0	Digital detection output. Goes to high if the detection algorithm finds a target in front of the sensor. 🔧 The detection area and other parameters of the detection algorithm can be easily changed over the instruction set.
3		VCC	Power supply pin (3.2 to 5.5V)	
4		RX	Serial interface RX input	
5		TX	Serial interface TX output	
6		Digital out 1	Digital miscellaneous output 1. The function is programmable over the instruction set. ⚠ This output is only valid together with a high on pin 2 except if it is configured as micro detection on output.	
7		Digital out 2	Digital miscellaneous output 2. The function is programmable over the instruction set. ⚠ This output is only valid together with a high on pin 2 except if it is configured as micro detection on output.	
8	Digital out 3	Digital miscellaneous output 3. The function is programmable over the instruction set. ⚠ This output is only valid together with a high on pin 2 except if it is configured as micro detection on output.		

# THEORY OF OPERATION

## Overview

The K-LD7 is a Doppler radar sensor and consists of an analogue RF frontend and a powerful signal processor with tracking and a fully digital serial interface. The RF frontend features one transmitter with a modulation input and two I/Q receivers. The signal processing unit modulates the frontend with a frequency step (FSK modulation) and samples the analogue I/Q Doppler signals for both transmit frequencies and for both receiving antennas. The processing of this sampled data allows the measurement and tracking of speed, direction, distance and angle of moving objects in the front of the sensor.

## Processing

The processing of the K-LD7 uses different processing stages to measure and track the speed, direction, distance and angle of moving targets. The last stage implements a configurable detection filter which generates a detection based on parameters like distance, angle or speed. The detection filter output is routed to the digital outputs. To get the full control in an application it is possible to read out the data of each processing step over the serial interface.

**Figure 4: Signal processing workflow**

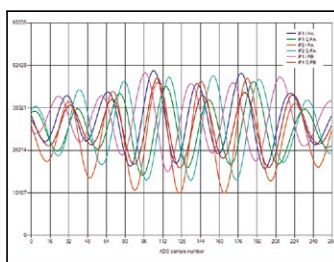

### Raw ADC data (RADC)

- Samples I/Q ADC data of receiver Rx1 and Rx2 for frequency A
- Samples I/Q ADC data of receiver Rx1 for frequency B

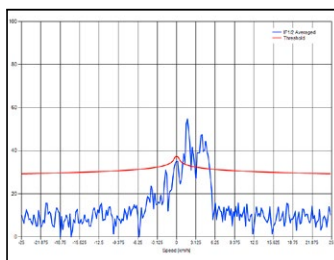

### Raw FFT data (RFFT)

- Calculates the complex FFT from the I/Q ADC data of Rx1 and Rx2 for frequency A
- Averages the two complex FFT's
- Adds the threshold line to the RFFT data

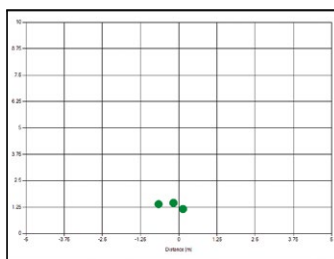

### Raw target data (PDAT)

- Search all targets above a threshold in the FFT
- Calculates the speed, direction, distance and angle of each target
- Generates the PDAT target list

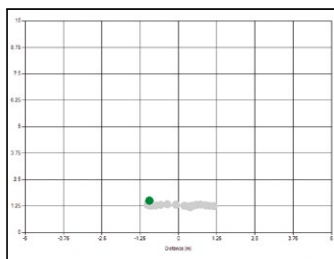

### Tracking data (TDAT)

- Cluster and track the dominant raw target
- Filter out interferences generated by fans or fluorescent light
- Predicts temporary lost objects
- Suppresses vibrations

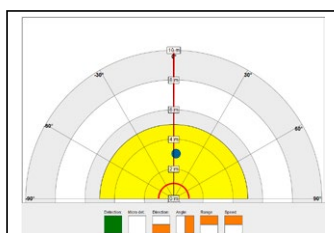

### Detection data (DDAT)

- Generates a detection if the tracked target matches the programmed detection filter criteria
- Check if there is a micro detection in the front of the sensor

## Speed and direction measurement

Every moving object in front of the sensor generates a Doppler frequency at the analogue outputs of the RF frontend. This Doppler frequency is proportional to the speed of the object. Moving direction is defined by the phase shift between the I/Q signals.

The K-LD7 calculates the speed and the direction for all raw targets. The direction is represented by the sign of the speed. A positive speed represents a receding and a negative speed an approaching movement.

The calculated speed is only correct if the movement of the object is radial to the sensor. If the movement is tangential the speed needs to be compensated by the angle of the movement compared to the sensor.

$$v_{real} = v_{measured} \cdot \cos(\alpha) [km/h]$$

**Figure 5: Tangential speed compensation**

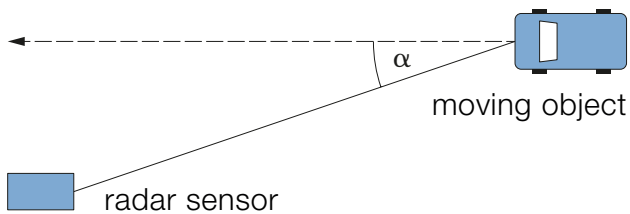

## Distance measurement

The distance measurement is based on the FSK principle. The signal processing unit quickly changes between two discrete RF frequencies and measures the ADC values for both transmitting frequencies which are available in the raw ADC data (RADC). After the detection of all raw targets above the threshold, the distance for each target is calculated based on the phase difference in both ADC signals.

## Angle measurement

The angle measurement is based on the angle of arrival principle. After the detection of all raw targets above the threshold, the angle for each target is calculated based on the phase difference between the two receiving channels.

The angle is calculated in degree and valid between  $\pm 90^\circ$ . If an object has an angle of zero it is directly in front of the sensor. A positive or negative angle defines if the target is more on the right or left side of the sensor.

**Figure 6: Positive and negative angle definition**

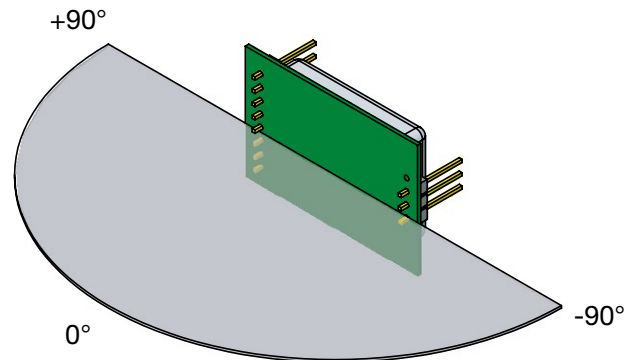

## Raw targets and tracking filter

A real object generates not only one raw target point. A moving person for example generates several raw target points with different speeds and different distances created by the torso, the legs and the arms. This generates a so called point cloud of different raw targets from one object. Depending on the environment where the sensor is used it will also see more or less reflexions generated by the moving object. The number of raw targets can be controlled by adjusting the threshold offset which is described in more detail in chapter Threshold offset on page 10.

To get a more usable output the sensor features a tracking filter to cluster and track the dominant target based on the raw targets. The filter includes a suppression of reflexions, vibrations and interferences and can also predict temporary lost targets what generates a smooth output.

The tracking filter can be adapted to various applications via the parameters Tracking filter type and Vibration suppression which is described in more detail in chapter Tracking on Page 10.



The filter can track only one target up to a distance of 30m.

**Figure 7: Raw targets vs. tracked target**

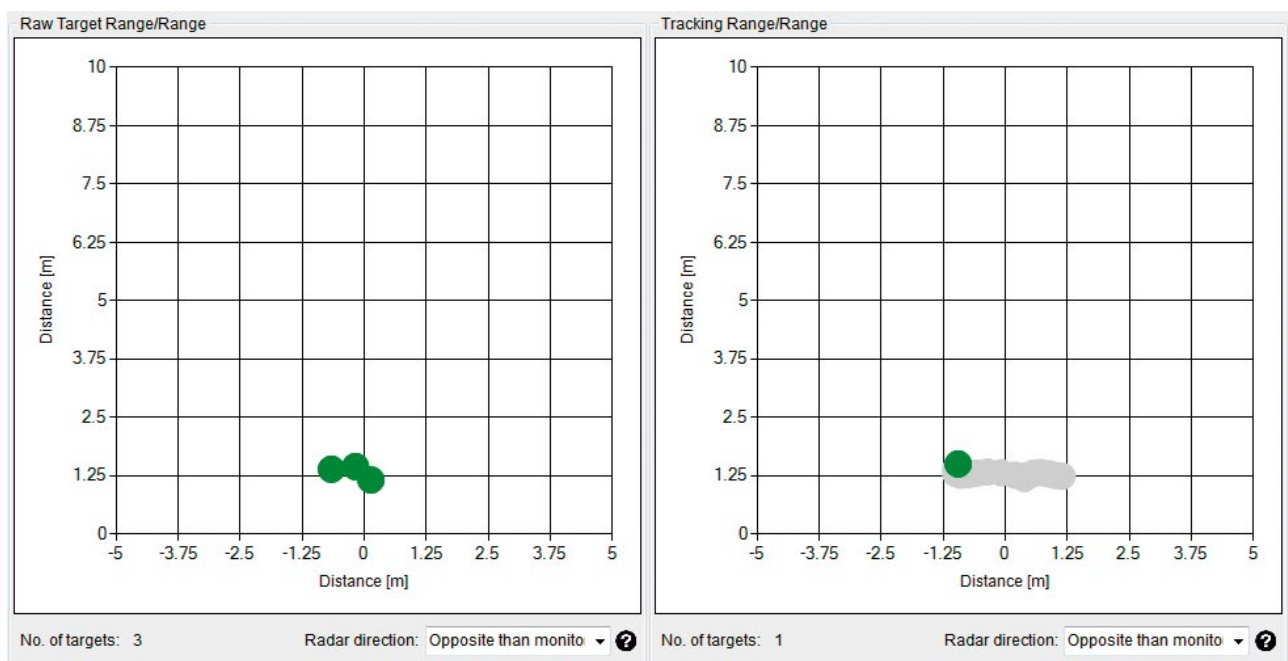

## Micro detection

The micro detection is a feature to detect very slow speeds in short range applications. It takes advantage of an algorithm that analyses the DC bin of the FFT to detect very slow speeds. The micro detection is independent from the normal detection algorithm and always enabled. It is available in the detection data structure DDAT and can be used to retrigger the hold time.

Further it is possible to adjust the sensitivity of the micro detection over the parameter „Micro detection sensitivity“.





The sensitivity of the micro detection depends on the used speed range setting. To get the best results always set the speed range first before adjusting the micro detection sensitivity parameter.

# APPLICATION INFORMATION

## Stand-alone operation

With standard settings the sensor is optimized for indoor detection of persons. The K-LD7 features four digital outputs which can directly be used without the need of an MCU. The digital outputs are per default configured in the following way:

**Table 2: Default digital output description**

Pin. No.	Name	Config	Description
2	Digital out 0	Detection	Digital detection output. Goes to high if the detection algorithm finds a target in front of the sensor that is in the range up to 5m.
6	Digital out 1	Direction	This pin signals the direction of the detected target. Low → backward/receding movement High → forward/approaching movement  This output is only valid together with a high on pin 2
7	Digital out 2	Angle	This pin signals if the angle of the detected target is on the left or right side of the sensor. Low → Target on the left side High → Target on the right side  This output is only valid together with a high on pin 2
8	Digital out 3	Range	This pin signals if the distance of the detected target is in the near field of the sensor. Low → Target distance higher than 1m High → Target distance lower than 1m  This output is only valid together with a high on pin 2

With these settings it is easy to use the sensor stand-alone as a distance triggered movement detector with direction recognition, near field option and including the information if the detection was on the left or right side of the sensor. All these settings can be also adjusted by the user as described in the next chapters.

 The K-LD7 can also be factory configured with your settings. Contact RFbeam for more information.

## Host driven operation

With a connection of the serial interface to a host (for example MCU or PC) it is possible to read out the complete processing data (RADC, RFFT, PDAT, TDAT and DDAT) and control all the parameters of the sensor. This is the recommended use case and allows the user to optimize the sensor easily for different applications.

 The use of the highest baud rate is only recommended to read out data intensive messages like the RADC and RFFT package.

**Figure 8: MCU or PC connection example**

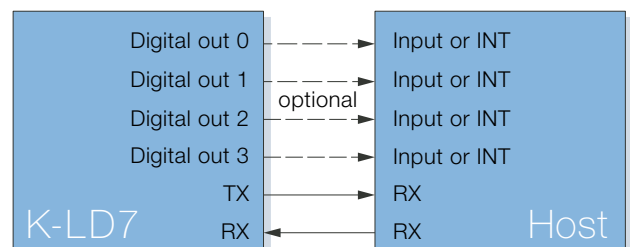



## Radar settings

The K-LD7 features different parameters to adjust the functionality of the sensor to the needs of different applications. All parameters are stored in the radar parameter structure which can be read and write over the serial interface. The structure and serial protocol is described in the chapter Instruction Set Description on page 13.

It is very important to set the distance and speed range settings to values that match with the distance and speed of the expected targets in the detection area of the sensor.

For example, if the goal is to measure people in the 10m distance range and 25km/h speed range, but cars are moving at 30m with 70km/h, the 100m distance range and 100km/h speed range setting must be used or the threshold offset needs to be increased until the cars are no longer displayed in the raw targets.



Wrong settings can generate false sensor outputs. It is possible that strong targets outside the configured distance or speed range can create false reflections.

### Distance range

The distance range parameter defines the maximum unambiguous distance measurement of the sensor. For a lower maximal distance range the range resolution is better but if the distance of a measured target is higher than the current distance range setting it can generate wrong measurements. Therefore it is very important to set the distance range to a setting where targets are expected.

**Table 3: Distance range settings**

Max. range [m]	Range resolution [cm]
5	5
10	10
30	30
100	100

An approach to work with a lower maximum distance range is to change the sensor orientation to get a field of view without moving objects above the maximal distance range or to increase the threshold offset (described in the chapter Threshold offset on page 10) to reduce the sensitivity of the sensor.

### Speed range

The speed range parameter defines the maximum unambiguous speed measurement of the sensor. For a lower maximal speed range the speed resolution is better and the current consumption is smaller but if the speed of a measured target is higher than the current speed range setting it can generate wrong measurements. Therefore it is very important to set the speed range to a setting where targets are expected.

**Table 4: Speed range settings**

Max. speed [km/h]	Speed resolution [km/h]	Typ. frame duration [ms]	Typ. Supply current [mA]
12.5	0.1	229	28
25	0.2	114	32
50	0.4	57	40
100	0.8	29	52

An approach to work with a lower maximum speed is to change the sensor orientation to get a field of view without moving objects above the maximal speed range or to increase the threshold offset (described in the chapter Threshold offset on page 10) to reduce the sensitivity of the sensor.



To read out data intensive messages RADC and RFFT it is recommended to work with the highest baud rate. If the readout time of the requested data is higher than the typ. frame duration it is not possible to read out the frames in real time. By checking the frame number in the DONE message it is possible to validate real time readout.

## Threshold offset

The threshold offset is adjustable and defines the distance in dB between the noise floor of the raw FFT data and the threshold line. The processing in the K-LD7 searches for raw targets that are above

this threshold line. The smaller the offset the more raw targets will be found by the processing and the more sensitive the sensor will be. A higher offset will reduce the sensitivity and the number of raw targets.

**Figure 9: Low vs. high threshold offset**

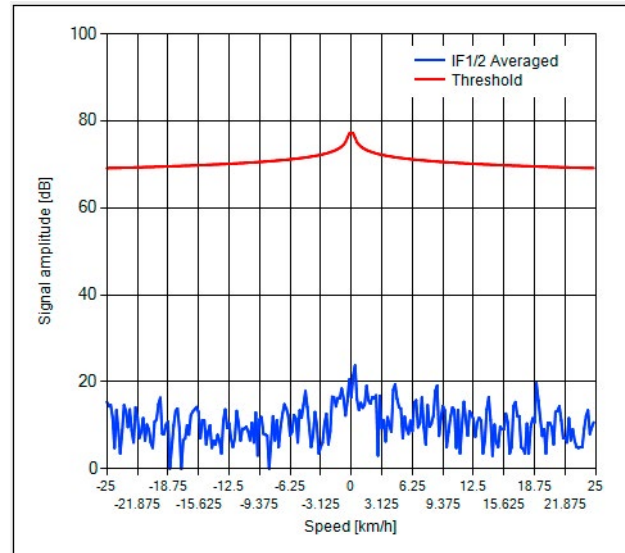
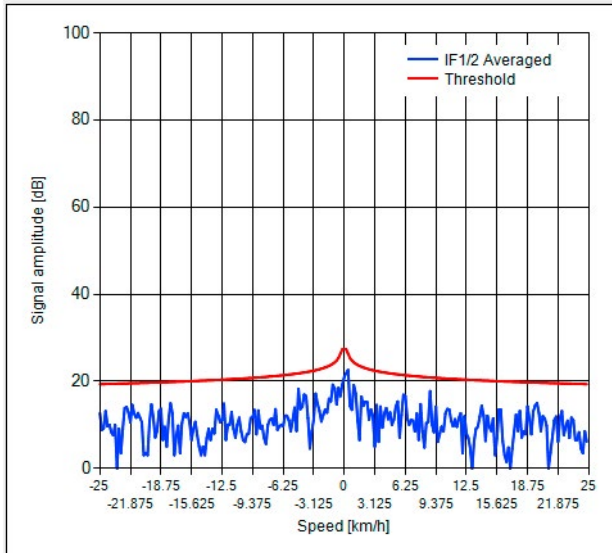

## Tracking and vibration suppression

The tracking filter features three different filter types and an adjustable vibration suppression. The filter type and the strength of vibration suppression can be selected via the instruction set.

With the vibration suppression, it is possible to more or less suppress targets that change their direction quickly, with the disadvantage that it takes more time to detect a target.



The filter can only track one target up to a distance of 30m.

**Table 5: Tracking filter types**

Filter type	Description
Standard	Standard filter type to track different targets like persons or cars
Fast detection	Enables a faster detection of the target with the disadvantage to reduce the immunity against reflexions and other interferences.
Long visibility	Filter with a high immunity against interferences and a high prediction of temporary lost targets

## Base frequency

There are three channels available to adjust the base transmit frequency of the sensor. This can be useful if multiple sensors are transmitting in the same area with the same base frequency to suppress the generated interferences that can occur in such an environment.

# Detection settings

## Detection filter

The last processing step in the K-LD7 generates a detection output based on a set of adjustable parameters. The information about the detection is available in the DDAT structure or on the digital outputs. The parameters are all located in the radar parameter structure which is described in detail in chapter Parameter structure on page 17.

**Table 7: Detection filter parameters**

Parameter name	Description
Min./max. detection distance	Used to limit the detection area to a minimum and maximum distance. Detection is only generated if the distance of the target is between the minimum and maximum detection distance limit.
Min./max. detection angle	Used to limit the detection area to a minimum and maximum angle. Detection is only generated if the angle of the target is between the minimum and maximum detection angle limit.
Min./max. detection speed	Used to filter out slow or fast targets. Detection is only generated if the speed of the target is between the minimum and maximum detection speed limit.  This filter already limits the PDAT raw targets in the signal processing chain.
Detection direction	Used to limit the detection by the direction. It is possible to detect only approaching or receding targets or to allow both directions.
Range threshold	Used to define a threshold for the range flag in the DDAT structure. Target distance > range threshold → DDAT range flag goes to low Target distance < range threshold → DDAT range flag goes to high.
Angle threshold	Used to define a threshold for the angle flag in the DDAT structure. Target angle < angle threshold → DDAT angle flag goes to low Target angle > angle threshold → DDAT angle flag goes to high.
Speed threshold	Used to define a threshold for the speed flag in the DDAT structure. Target speed < speed threshold → DDAT speed flag goes to low Target speed > speed threshold → DDAT speed flag goes to high.

The detection area of the sensor can easily be limited with these parameters and allow the user to generate very specific detections without the need of an advanced signal processing.



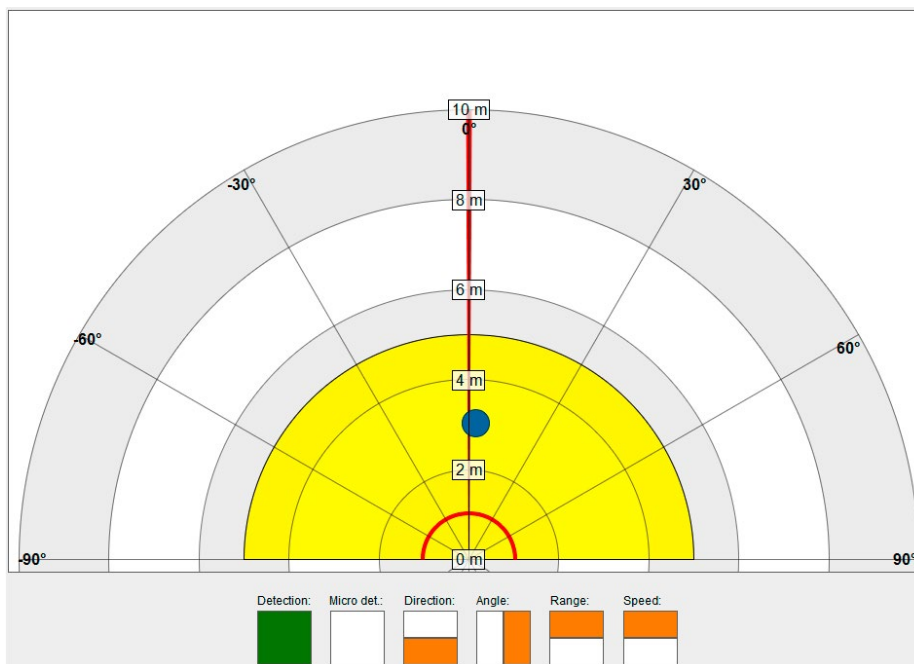

**Figure 10: Detection filter visualisation**



## Digital outputs

The sensor features four digital outputs to signal detection. The digital output 0 always signals if there was a valid detection. The function of the outputs 1 to 3 is configurable over the radar parameter structure. It is possible to route the values of the detection data structure DDAT to these outputs.

**Table 8: Routable functions for digital outputs 1 to 3**

Function	Description
Direction	Signals the direction of the detected target. Low → Backward/receding movement High → Forward/approaching movement  This output is only valid together with a valid detection
Angle	Signals if the angle of the detected target is below or above the angle threshold parameter. Low → Angle is below the angle threshold High → Angle is above the angle threshold  This output is only valid together with a valid detection
Range	Signals if the distance of the detected target is below or above the range threshold parameter. Low → Distance is above the range threshold High → Distance is below the range threshold  This output is only valid together with a valid detection
Speed	Signals if the speed of the detected target is below or above the speed threshold parameter. Low → Speed is below the speed threshold High → Speed is above the speed threshold  This output is only valid together with a valid detection
Micro detection	The micro detection indicates if there is a very slow movement in the front of the sensor. It is independent from the detection filter and described in detail in the chapter Micro detection on page 7.

## Hold time and micro detection retrigger

The time how long the detection output stays activated after the last valid detection can be adjusted with the hold time parameter.

Furthermore, it is possible to retrigger the detection algorithm using the micro detection feature (see parameter micro detection in the parameter structure). If this feature is enabled, the detection algorithm first requires a valid detection and then, if there was a valid micro detection, it will retrigger the hold time. If the hold time has elapsed because there was no detection or micro detection, the detection goes to low and needs again a valid detection before the micro detection is used to retrigger the hold time.



If the micro detection retrigger feature is enabled and there is a constant small movement in the front of the sensor it will retrigger the hold time continuously.

# INSTRUCTION SET DESCRIPTION

## Hardware Layer

The hardware layer is based on a simple RS-232 connection with a configurable baud rate. The sensor always starts up with its default baud rate. The default baud rate can be changed over the INIT command as described in the chapter Connection.

**Table 9: Default serial connection settings**

Parameter	Configuration
Baud rate	115200
Data bits	8
Parity	Even
Stop bits	1
Flow control	None

## Application Layer

### Client-Server

**Figure 11: Client-Server model**

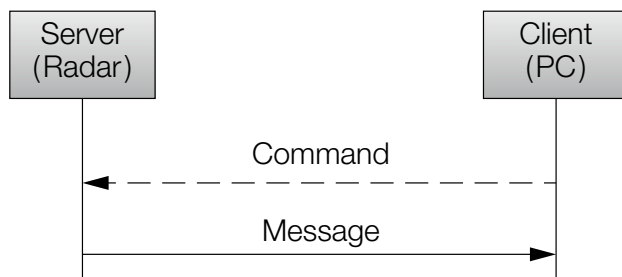

The communication is based on a client-server model. There are two types of packets transmitted. Commands are sent from client to server and messages are sent from server to client.

### Handshaking

**Figure 12: Handshaking**

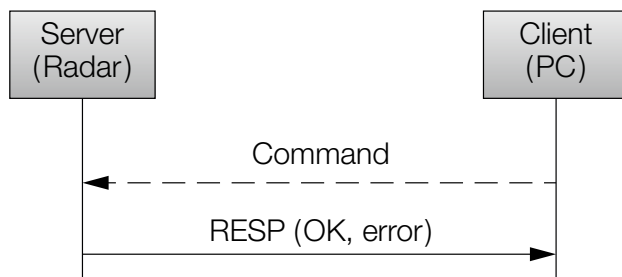

Every command sent by the client is acknowledged by the server with a response message (RESP). The response message includes information data about the success or failure of the received command.

### Connection

**Figure 13: Connection**

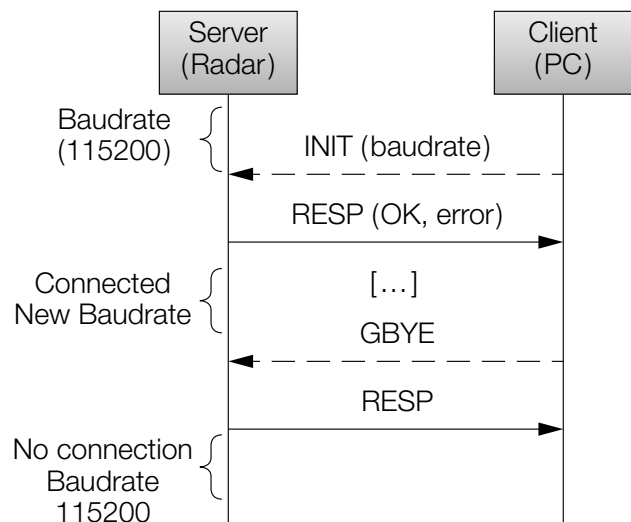

The server starts up with a default baud rate of 115200 baud. The client has to establish a connection with the INIT command and has to set the baud rate for the connection. After acknowledging of the INIT command the server changes to the selected baud rate.

To disconnect, the GBYE command has to be sent by the client. After acknowledging the GBYE message the server changes back to his default baud rate.

## Data output

Figure 14: Data output

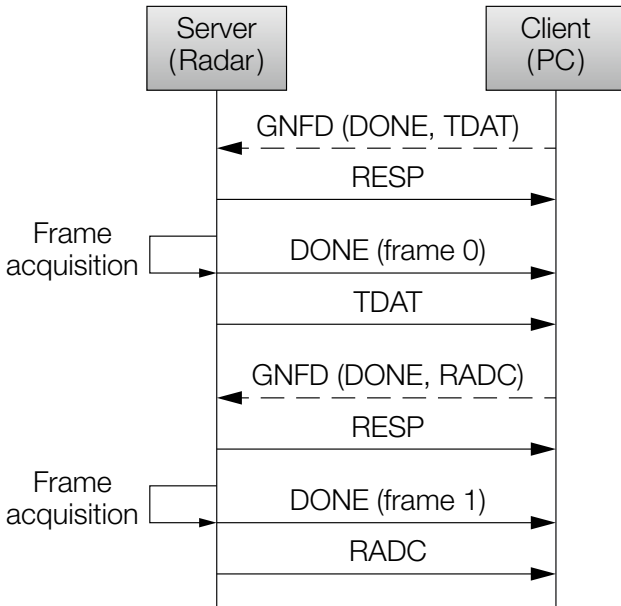

The client can request data messages with the GNFD command. Depending on the bits set in the GNFD command the enabled data messages will be sent out for the next acquired frame.

## Get and set parameter structure

Figure 15: Get parameter structure

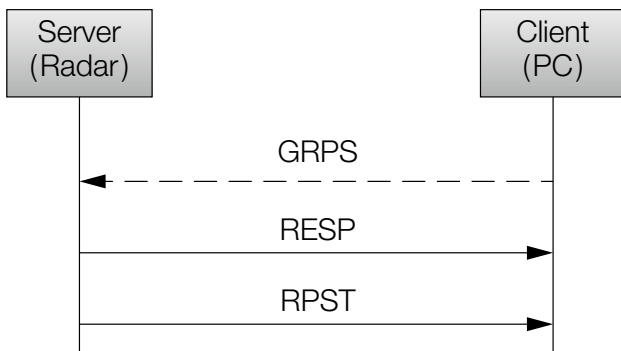

The client can set every parameter with a single command. But there is also the possibility to set all parameter together within a parameter structure or read this structure out. Please refer to chapter "Parameter structure" for detailed description of the parameter structure.

Figure 16: Set parameter structure

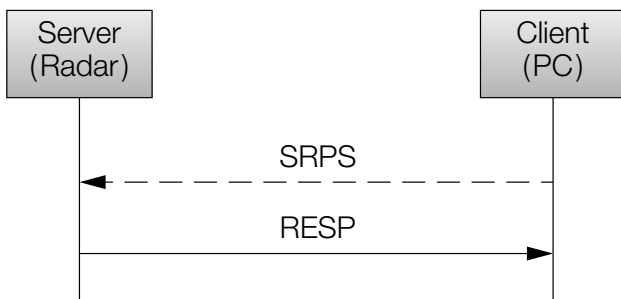

# Presentation Layer

All commands and messages sent have the format described in table below.

**Table 10: Packet format**

Description	Datatype	Length
<b>Header</b> The header describes the command or message type (e.g. RADC, RMRD, ...)	ASCII character	4 Bytes
<b>Payload Length</b> The payload length is always sent even if the payload is zero. It is sent as little endian (LSB first).	UINT32	4 Bytes
<b>Payload</b> The payload is message and command dependent. If the payload includes datatypes (e.g. UINT16, INT32, ...) then they are sent as little endian (LSB first).	Binary data	0–3072 Bytes

## Overview Messages and Commands

The table below shows the possible messages – see the chapter ‘Messages’ for details.

**Table 11: Application messages**

Header	Payload Length	Description
RADC	3072	Raw ADC values
RFFT	1024	Raw FFT
PDAT	0-96	The array of detected raw targets
TDAT	0-8	The array of tracked targets
DDAT	5	Detection data
DONE	4	Frame done
RPST	42	Radar parameter structure
RESP	1	Response, Acknowledge

**Table 12: Application commands**

Header	Payload Length	Description
INIT	4	Start of connection
GNFD	4	Get next frame data
GRPS	0	Get radar parameter structure
SRPS	42	Set radar parameter structure
RFSE	0	Restore factory settings
GBYE	0	Disconnect
RBFR	4	Base frequency
RSPI	4	Maximum speed
RRAI	4	Maximum range
THOF	4	Threshold offset
TRFT	4	Tracking filter type
VISU	4	Vibration suppression
MIRA	4	Minimum detection distance
MARA	4	Maximum detection distance
MIAN	4	Minimum detection angle
MAAN	4	Maximum detection distance
MISP	4	Minimum detection speed
MASP	4	Maximum detection speed
DEDI	4	Detection direction
RATH	4	Range threshold
ANTH	4	Angle threshold
SPTH	4	Speed threshold
DIG1	4	Digital output 1
DIG2	4	Digital output 2
DIG3	4	Digital output 3
HOLD	4	Hold time
MIDE	4	Micro detection retrigger
MIDS	4	Micro detection sensitivity

## Parameter structure

The radar has a set of parameter which can be modified with commands. The structure can be read out by the GRPS command and set by the SRPS command.

**Table 13: Radar parameter structure**

Description	Datatype	Length	Values	Default
Software Version	STRING	19	Zero-terminated String	K-LD7_APP-RFB-XXXX
Base frequency	UINT8	1	0 = Low, 1 = Middle, 2 = High	1 = Middle
Maximum speed	UINT8	1	0 = 12.5km/h, 1 = 25km/h, 2 = 50km/h, 3 = 100km/h	1 = 25km/h
Maximum range	UINT8	1	0 = 5m, 1 = 10m, 2 = 30m, 3 = 100m	1 = 10m
Threshold offset	UINT8	1	10-60 dB	30 dB
Tracking filter type	UINT8	1	0 = Standard, 1 = Fast detection, 2 = Long visibility	0 = Standard
Vibration suppression	UINT8	1	0-16, 0 = No suppression, 16 = High suppression	3 = Medium suppression
Minimum detection distance	UINT8	1	0-100% of range setting	0%
Maximum detection distance	UINT8	1	0-100% of range setting	50%
Minimum detection angle	INT8	1	-90° to +90°	-90°
Maximum detection angle	INT8	1	-90° to +90°	+90°
Minimum detection speed	UINT8	1	0-100% of speed setting	0%
Maximum detection speed	UINT8	1	0-100% of speed setting	100%
Detection direction	UINT8	1	0 = Approaching, 1 = Receding, 2 = Both	2 = Both
Range threshold	UINT8	1	0-100% of range setting	10%
Angle threshold	INT8	1	-90° to +90°	0°
Speed threshold	UINT8	1	0-100% of speed setting	50%
Digital output 1	UINT8	1	0 = Direction, 1 = Angle, 2 = Range, 3 = Speed, 4 = Micro detection	0 = Direction
Digital output 2	UINT8	1	0 = Direction, 1 = Angle, 2 = Range, 3 = Speed, 4 = Micro detection	1 = Angle
Digital output 3	UINT8	1	0 = Direction, 1 = Angle, 2 = Range, 3 = Speed, 4 = Micro detection	2 = Range
Hold time	UINT16	2	1-7200s (1s-2h)	120s → 2min
Micro detection retrigger	UINT8	1	0 = Off, 1 = Retrigger	0 = Off
Micro detection sensitivity	UINT8	1	0-9, 0=Min. sensitivity, 9=Max. sensitivity	4 = Medium sensitivity



## Messages

This chapter provides detailed information about the messages of the K-LD7.

**Table 14: Application messages**

Header	Payload Length	Description	Payload																								
RADC	3072	Raw ADC values	<table border="1"> <thead> <tr> <th>Description:</th> <th>Datatype</th> <th>Length</th> </tr> </thead> <tbody> <tr> <td>IF1 Frequency A 256 values of I-Channel 256 values of Q-Channel</td> <td>UINT16</td> <td>1024</td> </tr> <tr> <td>IF2 Frequency A 256 values of I-Channel 256 values of Q-Channel</td> <td>UINT16</td> <td>1024</td> </tr> <tr> <td>IF1 Frequency B 256 values of I-Channel 256 values of Q-Channel</td> <td>UINT16</td> <td>1024</td> </tr> </tbody> </table>	Description:	Datatype	Length	IF1 Frequency A 256 values of I-Channel 256 values of Q-Channel	UINT16	1024	IF2 Frequency A 256 values of I-Channel 256 values of Q-Channel	UINT16	1024	IF1 Frequency B 256 values of I-Channel 256 values of Q-Channel	UINT16	1024												
Description:	Datatype	Length																									
IF1 Frequency A 256 values of I-Channel 256 values of Q-Channel	UINT16	1024																									
IF2 Frequency A 256 values of I-Channel 256 values of Q-Channel	UINT16	1024																									
IF1 Frequency B 256 values of I-Channel 256 values of Q-Channel	UINT16	1024																									
RFFT	1024	Raw FFT	<table border="1"> <thead> <tr> <th>Description:</th> <th>Datatype</th> <th>Length</th> </tr> </thead> <tbody> <tr> <td>Spectrum 256 values</td> <td>UINT16</td> <td>512</td> </tr> <tr> <td>Threshold 256 values</td> <td>UINT16</td> <td>512</td> </tr> </tbody> </table>	Description:	Datatype	Length	Spectrum 256 values	UINT16	512	Threshold 256 values	UINT16	512															
Description:	Datatype	Length																									
Spectrum 256 values	UINT16	512																									
Threshold 256 values	UINT16	512																									
PDAT	0–96	The array of detected raw targets	<p>The following data structure will be added for every detected raw target:</p> <table border="1"> <thead> <tr> <th>Description:</th> <th>Datatype</th> <th>Length</th> </tr> </thead> <tbody> <tr> <td>Distance [cm]</td> <td>UINT16</td> <td>2</td> </tr> <tr> <td>Speed [km/h × 100]</td> <td>INT16</td> <td>2</td> </tr> <tr> <td>Angle [deg × 100]</td> <td>INT16</td> <td>2</td> </tr> <tr> <td>Magnitude of target</td> <td>UINT16</td> <td>2</td> </tr> </tbody> </table>	Description:	Datatype	Length	Distance [cm]	UINT16	2	Speed [km/h × 100]	INT16	2	Angle [deg × 100]	INT16	2	Magnitude of target	UINT16	2									
Description:	Datatype	Length																									
Distance [cm]	UINT16	2																									
Speed [km/h × 100]	INT16	2																									
Angle [deg × 100]	INT16	2																									
Magnitude of target	UINT16	2																									
TDAT	0–8	Tracked target structure	<table border="1"> <thead> <tr> <th>Description:</th> <th>Datatype</th> <th>Length</th> </tr> </thead> <tbody> <tr> <td>Distance [cm]</td> <td>UINT16</td> <td>2</td> </tr> <tr> <td>Speed [km/h × 100]</td> <td>INT16</td> <td>2</td> </tr> <tr> <td>Angle [deg × 100]</td> <td>INT16</td> <td>2</td> </tr> <tr> <td>Magnitude of target</td> <td>UINT16</td> <td>2</td> </tr> </tbody> </table>	Description:	Datatype	Length	Distance [cm]	UINT16	2	Speed [km/h × 100]	INT16	2	Angle [deg × 100]	INT16	2	Magnitude of target	UINT16	2									
Description:	Datatype	Length																									
Distance [cm]	UINT16	2																									
Speed [km/h × 100]	INT16	2																									
Angle [deg × 100]	INT16	2																									
Magnitude of target	UINT16	2																									
DDAT	6	Detection data	<table border="1"> <thead> <tr> <th>Description:</th> <th>Datatype</th> <th>Length</th> </tr> </thead> <tbody> <tr> <td>Description</td> <td>Datatype</td> <td>Length</td> </tr> <tr> <td>Detection flag 0 = No detection, 1 = Detection</td> <td>UINT8</td> <td>1</td> </tr> <tr> <td>Micro detection flag 0 = No detection, 1 = Detection</td> <td>UINT8</td> <td>1</td> </tr> <tr> <td>Angle flag 0 = Left, 1 = Right</td> <td>UINT8</td> <td>1</td> </tr> <tr> <td>Direction flag 0 = Approaching, 1 = Receding</td> <td>UINT8</td> <td>1</td> </tr> <tr> <td>Range flag 0 = Far, 1 = Near</td> <td>UINT8</td> <td>1</td> </tr> <tr> <td>Speed flag 0 = Low speed, 1 = High speed</td> <td>UINT8</td> <td>1</td> </tr> </tbody> </table> <p> The angle, direction, range and speed flag is only valid if the detection flag is 1.</p>	Description:	Datatype	Length	Description	Datatype	Length	Detection flag 0 = No detection, 1 = Detection	UINT8	1	Micro detection flag 0 = No detection, 1 = Detection	UINT8	1	Angle flag 0 = Left, 1 = Right	UINT8	1	Direction flag 0 = Approaching, 1 = Receding	UINT8	1	Range flag 0 = Far, 1 = Near	UINT8	1	Speed flag 0 = Low speed, 1 = High speed	UINT8	1
Description:	Datatype	Length																									
Description	Datatype	Length																									
Detection flag 0 = No detection, 1 = Detection	UINT8	1																									
Micro detection flag 0 = No detection, 1 = Detection	UINT8	1																									
Angle flag 0 = Left, 1 = Right	UINT8	1																									
Direction flag 0 = Approaching, 1 = Receding	UINT8	1																									
Range flag 0 = Far, 1 = Near	UINT8	1																									
Speed flag 0 = Low speed, 1 = High speed	UINT8	1																									
DONE	4	Frame done	Frame number since reset																								
RPST	42	Radar parameter structure	See chapter "Parameter structure" for details																								
RESP	1	Response, Acknowledge	<table border="1"> <thead> <tr> <th>Description:</th> <th>Datatype</th> <th>Length</th> </tr> </thead> <tbody> <tr> <td>Acknowledge information 0 = OK, 1 = Unknown command, 2 = Invalid parameter value, 3 = Invalid RPST version, 4 = Uart error (parity, framing, noise), 5 = Sensor busy</td> <td>UINT8</td> <td>1</td> </tr> </tbody> </table>	Description:	Datatype	Length	Acknowledge information 0 = OK, 1 = Unknown command, 2 = Invalid parameter value, 3 = Invalid RPST version, 4 = Uart error (parity, framing, noise), 5 = Sensor busy	UINT8	1																		
Description:	Datatype	Length																									
Acknowledge information 0 = OK, 1 = Unknown command, 2 = Invalid parameter value, 3 = Invalid RPST version, 4 = Uart error (parity, framing, noise), 5 = Sensor busy	UINT8	1																									

## Commands

This chapter provides detailed information about the commands.

**Table 15: Application commands**

Header	Payload Length	Description	Values
INIT	4	Start of connection	0 = 115200, 1 = 460800, 2 = 921600, 3 = 2000000, 4 = 3000000
GNFD	4	Get next frame data	Binary coded bit-field. 0 = disabled, 1 = enabled 0x01 = RADC, 0x02 = RFFT, 0x04 = PDAT, 0x08 = TDAT, 0x10 = DDAT, 0x20 = DONE
GRPS	0	Get radar parameter structure	–
SRPS	42	Set radar parameter structure	See chapter “Parameter structure” for details
RFSE	0	Restore factory settings	–
GBYE	0	Disconnect	–
RBFR	4	Base frequency	0 = Low, 1 = Middle, 2 = High
RSPI	4	Maximum speed	0 = 12.5 km/h, 1 = 25 km/h, 2 = 50 km/h, 3 = 100 km/h
RRAI	4	Maximum range	0=5m, 1=10m, 2=30m, 3=100m
THOF	4	Threshold offset	10–60 dB
TRFT	4	Tracking filter type	0 = Standard, 1 = Fast detection, 2 = Long visibility
VISU	4	Vibration suppression	0-16, 0 = No suppression, 16 = High suppression
MIRA	4	Minimum detection distance	0–100 % of range setting
MARA	4	Maximum detection distance	0–100 % of range setting
MIAN	4	Minimum detection angle	-90° to +90°
MAAN	4	Maximum detection angle	-90° to +90°
MISP	4	Minimum detection speed	0–100 % of speed setting
MASP	4	Maximum detection speed	0–100 % of speed setting
DEDI	4	Detection direction	0 = Approaching, 1 = Receding, 2 = Both
RATH	4	Range threshold	0–100 % of range setting
ANTH	4	Angle threshold	-90° to +90°
SPTH	4	Speed threshold	0–100 % of speed setting
DIG1	4	Digital output 1	0 = Direction, 1 = Angle, 2 = Range, 3 = Speed, 4 = Micro detection
DIG2	4	Digital output 2	0 = Direction, 1 = Angle, 2 = Range, 3 = Speed, 4 = Micro detection
DIG3	4	Digital output 3	0 = Direction, 1 = Angle, 2 = Range, 3 = Speed, 4 = Micro detection
HOLD	4	Hold time	1–7200 s
MIDE	4	Micro detection retrigger	0 = Off, 1 = Retrigger
MIDS	4	Micro detection sensitivity	0-9, 0=Min. sensitivity, 9=Max. sensitivity

# OUTLINE DIMENSIONS

Figure 17: Outline dimensions in millimetre

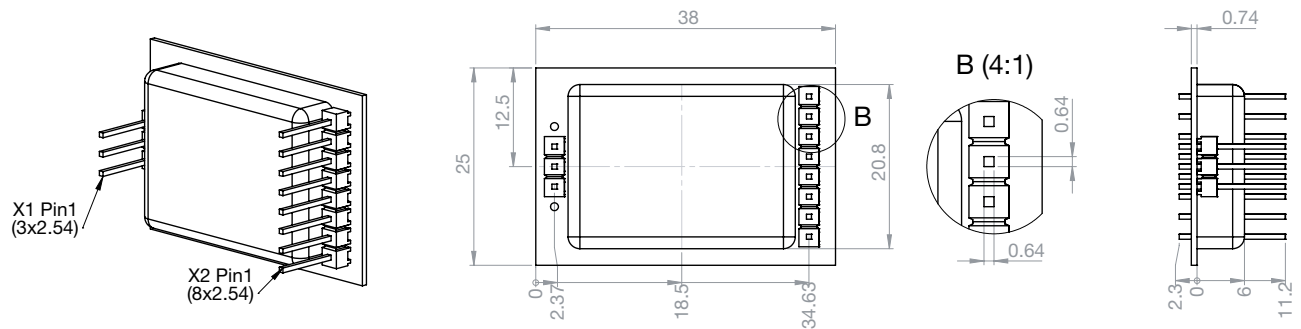

# ORDER INFORMATION

The ordering number consists of different parts with the structure below

Figure 18: Ordering number structure



Table 16: Available ordering numbers

Ordering number	Description
K-LD7-RFB-00H-01	Standard K-LD7 with default configuration, without PC software
K-LD7-EVAL-RFB-01H	Standard K-LD7 evaluation kit with powerful PC software

 It is possible to order K-LD7 sensors with pre-programmed custom settings. Contact RFbeam for more information.

# REVISION HISTORY

09/2019 – Revision A: Initial Version