

Features

- Small Body Outline Dimensions:
0.039" x 0.024" (1.0 mm x 0.60 mm)
- Protects one I/O or power line
- Low Clamping Voltage
- Ultra Low Capacitance:0.4pF
- Working Voltage: 5 V
- Low Leakage Current
- Response Time is Typically < 1 ns

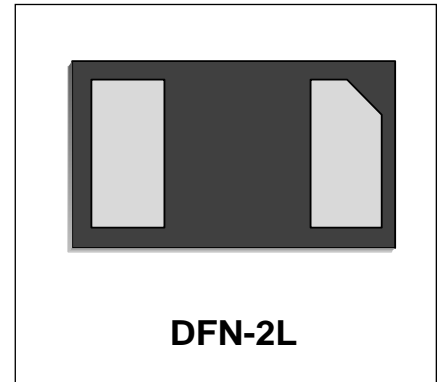

IEC COMPATIBILITY (EN61000-4)

- IEC 61000-4-2 (ESD) $\pm 30\text{kV}$ (air), $\pm 30\text{kV}$ (contact)
- IEC 61000-4-4 (EFT) 40A (5/50ns)

Mechanical Characteristics

- DFN-2L package
- Molding compound flammability rating:
UL 94V-0
- Marking: Marking Code
- Packaging: Tape and Reel per EIA 481
- RoHS Compliant

Applications

- Laptop Computers
- Cellular Phones
- Digital Cameras
- Personal Digital Assistants (PDAs)

Schematic & PIN Configuration

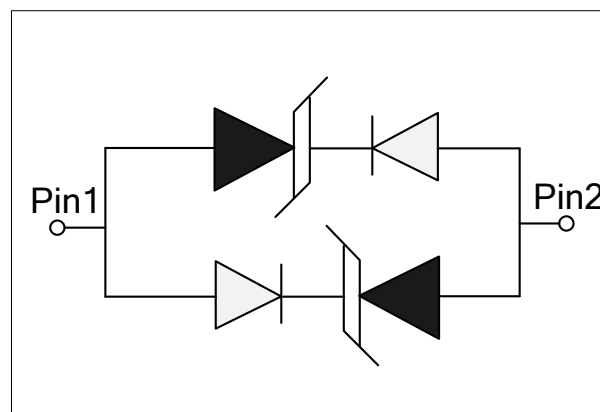

Absolute Maximum Rating			
Rating	Symbol	Value	Units
Electrostatic discharge Voltage (See Note1 ,2)	V _{ESD}	30 (contact)	KV
		30 (air)	
Operating Temperature	T _J	-55 to + 125	°C
Storage Temperature	T _{STG}	-55 to +150	°C

Electrical Parameters (T=25°C)

Symbol	Parameter
I _{PP}	Maximum Reverse Peak Pulse Current
V _C	Clamping Voltage @ I _{PP}
V _{RWM}	Working Peak Reverse Voltage
I _R	Maximum Reverse Leakage Current @ V _{RWM}
V _{BR}	Breakdown Voltage @ I _T
I _T	Test Current

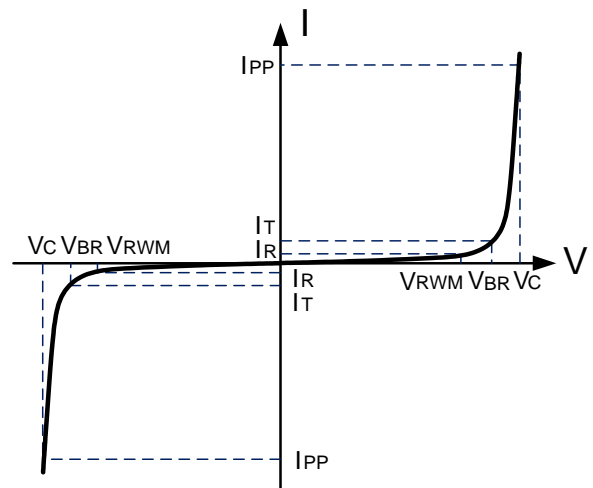

Electrical Characteristics

WE05DUCF-BF						
Parameter	Symbol	Conditions	Minimum	Typical	Maximum	Units
Reverse Stand-Off Voltage	V _{RWM}				5.0	V
Reverse Breakdown Voltage	V _{BR}	I _T =1mA	6.0			V
Reverse Leakage Current	I _R	V _{RWM} =5V, T=25°C			0.5	µA
Clamping Voltage	V _C	I _{PP} =1A, t _p =8/20µs		8.5	10	V
Junction Capacitance	C _j	V _R = 0V, f= 1MHz		0.4	0.6	pF

Note1: ESD Pulse Waveform according to IEC 61000-4-2. see Table1 and Figure4.

Note2: ESD tests Setup see Figure 5.

Typical Characteristics

Figure 1: Power Derating Curve

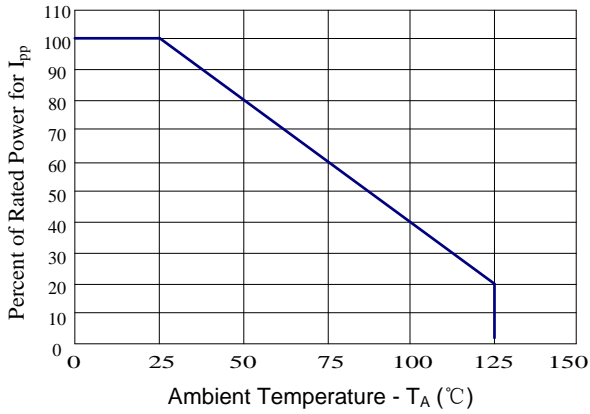

Figure 2: Insertion Loss



Figure 3: Normalized Junction Capacitance vs. Reverse Voltage

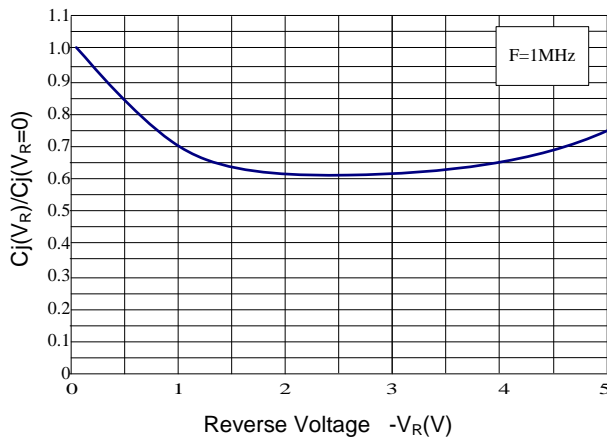

Table 1. IEC 61000-4-2 Discharge Parameters

Level	First Peak Current (A)	Peak Current at 30 ns (A)	Peak Current at 60 ns (A)	Test Voltage (Contact Discharge) (kV)	Test Voltage (Air Discharge) (kV)
1	7.5	4	2	2	2
2	15	8	4	4	4
3	22.5	12	6	6	8
4	30	16	8	8	15

Figure 4. IEC 61000-4-2 Waveform

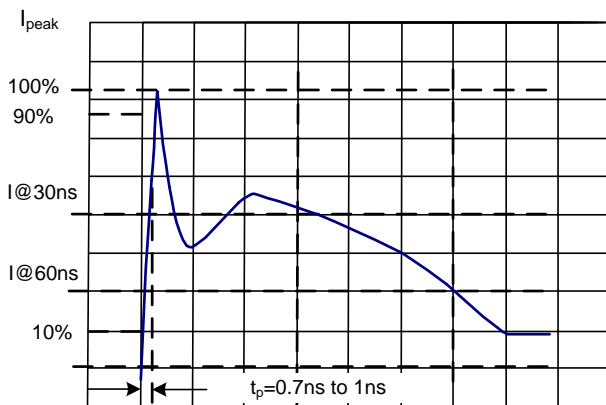
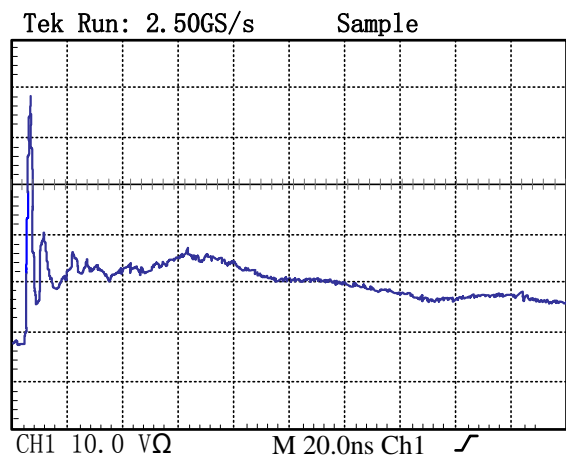

Figure 5: ESD Clamping(8kV Contact per IEC 61000-4-2)



Outline Drawing –DFN-2L

PACKAGE OUTLINE

BOTTOM VIEW

DFN-2L

SYMBOL	MILIMETER		
	MIN	NOM	MA
A	0.45	0.50	0.55
A1	0	0.02	0.05
b	0.45	0.50	0.55
C	0.12	0.15	0.18
D	0.95	1.00	1.05
e	0.65BSC		
E	0.55	0.60	0.65
L	0.20	0.25	0.30
L1	0.05REF		
h	0.07	0.12	0.17

Land Pattern

Marking Codes

Part Number	Marking Code
WE05DUCF-BF	5 T

Package Information

Qty: 10k/Reel

CONTACT INFORMATION

CYG WAYON CIRCUIT PROTECTION CO., LTD.

No.1001, Shiwan(7) Road, Pudong District, Shanghai, P.R.China.201202

Tel: 86-21-68969993 Fax: 86-21-50757680 Email: market@way-on.com

WAYON website: <http://www.way-on.com>

For additional information, please contact your local Sales Representative.

CYWAYON® is registered trademark of Wayon Corporation.

Specifications are subject to change without notice.
The device characteristics and parameters in this data sheet can and do vary in different applications and actual device performance may vary over time.
Users should verify actual device performance in their specific applications.