

GR3A THRU GR3M Fast Recovery Rectifier

Features

- High efficiency
- High current capability
- High reliability
- High surge current capability
- Low power loss
- Glass passivated chip junction
- Solder dip 265 °C max. 10 s, per JESD 22-B106

Typical Applications

For use in general purpose rectification of power supplies, inverters, converters, and freewheeling diodes for consumer, and telecommunication.

Mechanical Data

- Package: SMC
- Molding compound meets UL 94 V-0 flammability rating, RoHS-compliant
- Terminals: Tin plated leads, solderable per J-STD-002 and JESD22-B102
- Polarity: Color band denotes cathode end

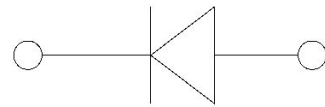
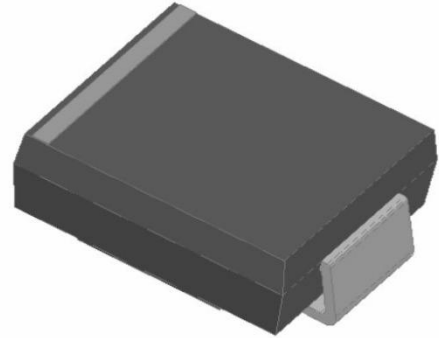

■ Maximum Ratings (Ta=25°C Unless otherwise specified)

PARAMETER	Symbol	Unit	GR3						
			A	B	D	G	J	K	M
Maximum Repetitive Peak Reverse Voltage	V _{RRM}	V	50	100	200	400	600	800	1000
Maximum RMS Voltage	V _{RMS}	V	35	70	140	280	420	560	700
Maximum DC blocking Voltage	V _{DC}	V	50	100	200	400	600	800	1000
Average Forward Current @Half-sine wave, Resistance load, Tc(Fig.1)	I _o	A	3.0						
Forward Surge Current (Non-repetitive) @60HZ sine wave, 1 cycle, Ta=25°C	I _{FSM}	A	100						
Current squared time @1ms≤t8.3≤ms Ta=25°C, Rating of per diode	I ² t	A ² s	41.5						
Thermal Resistance(Typical) @Between junction and ambient	R _{θJ-A}	°C/W	50						
Storage Temperature	T _{stg}	°C	-55 ~ +150						
Junction Temperature	T _j	°C	-55 ~ +150						

■ Electrical Characteristics (Ta=25°C Unless otherwise specified)

PARAMETER	Symbol	Unit	Conditions	GR3					
				A	B	D	G	J	K
Peak Forward Voltage	V _{FM}	V	I _F = 3.0A	1.3					
Peak Reverse Current	I _{RRM}	μA	VR = V _{DC} @Ta=25°C	10					
			VR = V _{DC} @Ta=125°C	250					
Maximum reverse recovery time	T _{rr}	ns	I _F =0.5A, I _R =1.0A, I _{rr} =0.25A	150			250	500	



GR3A THRU GR3M

■ Characteristics (Typical)

FIG.1: Io-TL Curve

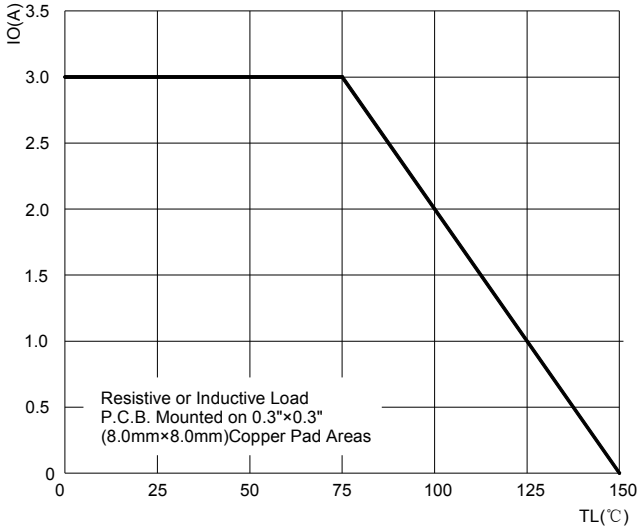

FIG.2: Forward Surge Current Capability

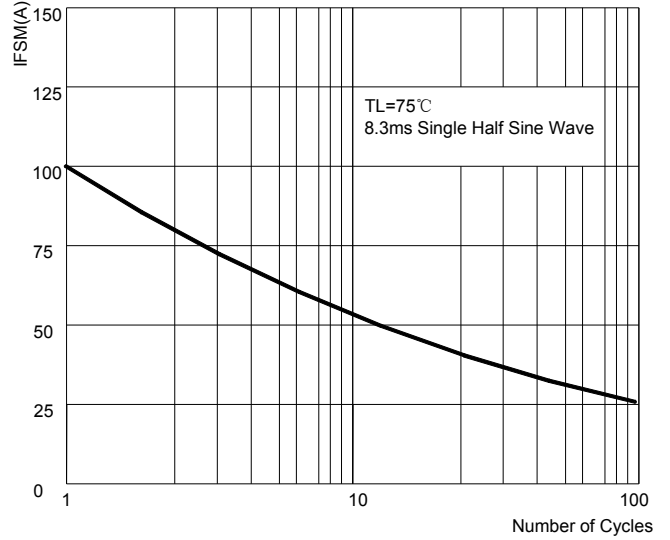

FIG.3: Forward Voltage

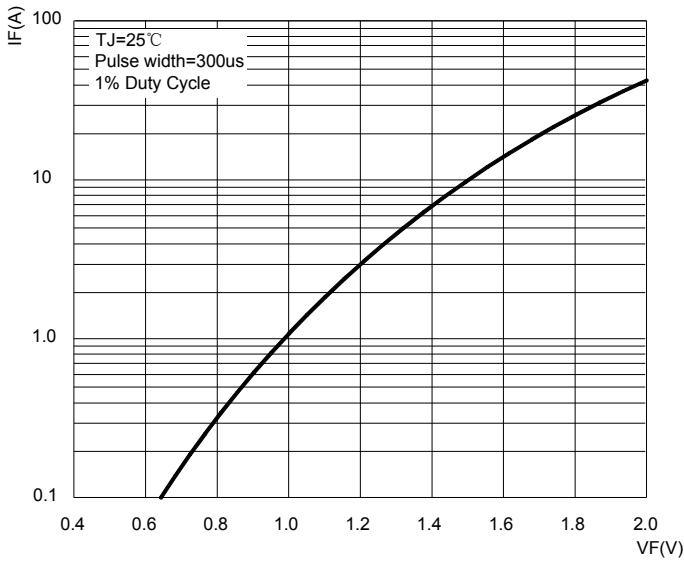

FIG.4: Typical Reverse Characteristics

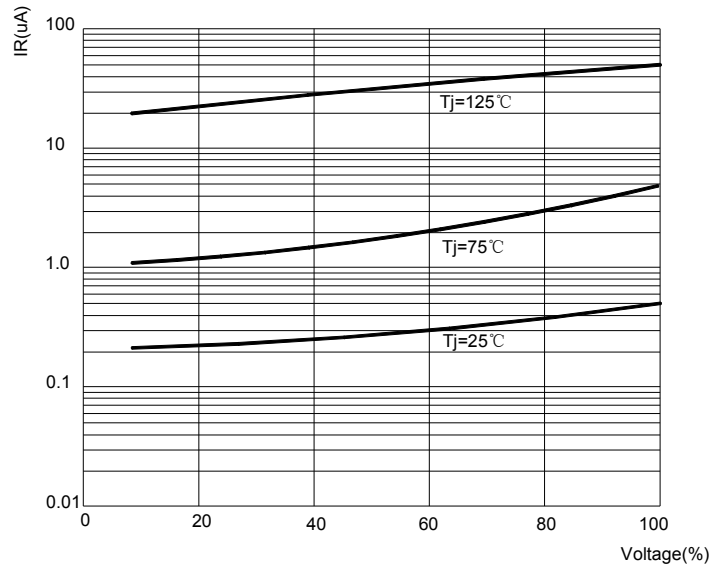
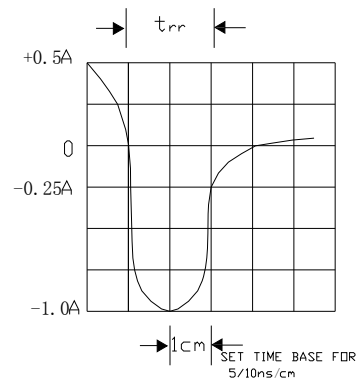
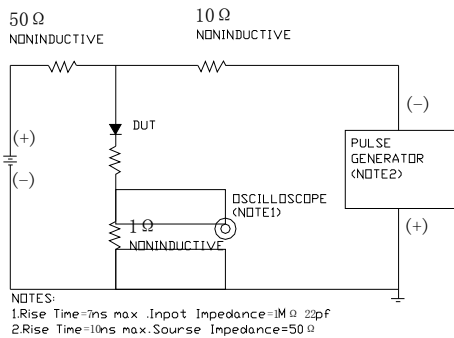

FIG.5: Diagram of circuit and Testing wave form of reverse recovery time



GR3A THRU GR3M

■ Ordering Information (Example)

PREFERED	PACKAGE CODE	MINIMUM PACKAGE(pcs)	INNER BOX QUANTITY(pcs)	OUTER CARTON QUANTITY(pcs)	DELIVERY MODE
GR3A THRU GR3M	SMC	3000	6000	42000	13"reel

■ Outline Dimensions

