

UNCONTROLLED DOCUMENT

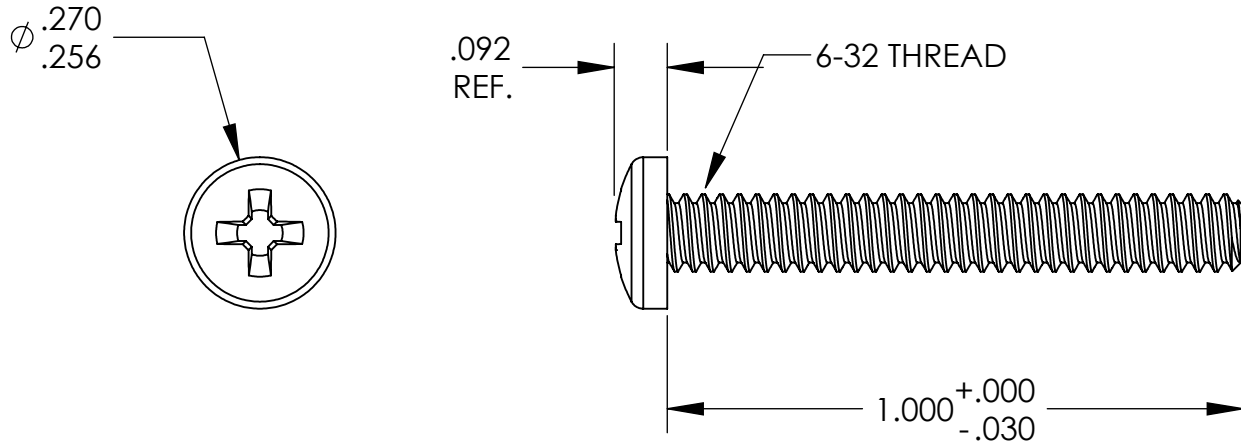

TOLERANCES UNLESS NOTED

- ±.005 ON DIMENSIONS THRU .625
- ±.008 ON DIMENSIONS .626 THRU 1.000
- ±.010 ON DIMENSIONS 1.001 THRU 1.500
- ±.015 ON DIMENSIONS LARGER THAN 1.500
- ±.015 ON FRACTIONAL DIMENSIONS

WE RESERVE THE RIGHT
TO DISCONTINUE ITEMS,
CHANGE SPECIFICATIONS
OR DESIGN AT ANY TIME
WITHOUT NOTICE AND
WITHOUT INCURRING
ANY OBLIGATIONS

PROPERTY OF		
MICRO PLASTICS INC.		
CATALOG DRAWING PAN HEAD PHILLIPS MICRO P/N 010632PW100 DWG. # 010632PW100 FILE SERVER\ENG\WEB		
MATERIAL:		NYLON 6/6
DATE	SCALE 3:1	TA