

Silicon Epitaxial Planar Diode

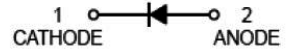

Features:

- Fast Switching Speed
- Surface Mount Package Ideally Suited for Automatic Insertion
- For General Purpose Switching Applications
- High Conductance



SOD-323

Applications:

Surface mount fast switching diode

Max. Rating @ T_A = 25°C unless otherwise specified

Parameter	Symbol	Limits	Unit
Repetitive peak reverse voltage	V _{RRM}	250	V
Working peak reverse voltage DC reverse voltage	V _{RMS} V _R	200	V
RMS reverse voltage	V _{R(RMS)}	141	V
Forward continuous current	I _{FM}	400	mA
Average rectified output current	I _O	200	mA
Non-Repetitive peak forward surge current @t=1μs @t=1s	I _{FSM}	2.5 0.5	mA
Repetitive peak forward surge current	I _{FRM}	625	mA
Power dissipation	P _D	200	mW
Thermal resistance junction to ambient air	R _{θJA}	625	°C/W
Operating and storage temperature range	T _j , T _{STG}	-65 to +150	°C

Electrical Characteristics @ T_A = 25°C unless otherwise specified

Parameter	Symbol	Conditions	Min.	Max.	Unit
Forward voltage	V _{FM}	I _F = 100mA I _F = 200mA	-	1 1.25	V
Reverse current	I _R	V _R = 150V	-	0.1	μA
Capacitance between terminals	C _T	V _R = 0V, f = 1MHz	-	5	pF
Reverse recovery time	t _{rr}	I _F = I _R = 30mA, I _{rr} = 0.1 × I _R , R _L = 100Ω	-	50	ns

Silicon Epitaxial Planar Diode



Typical Characteristics @ $T_A = 25^\circ\text{C}$ unless otherwise specified

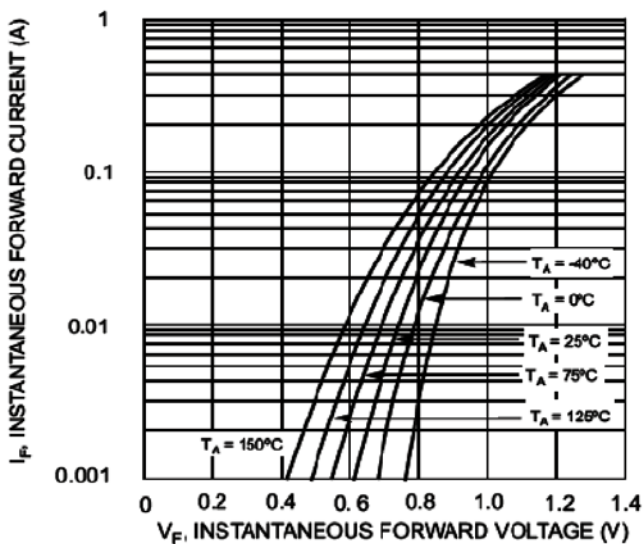

Fig. 1 Typical Forward Characteristics

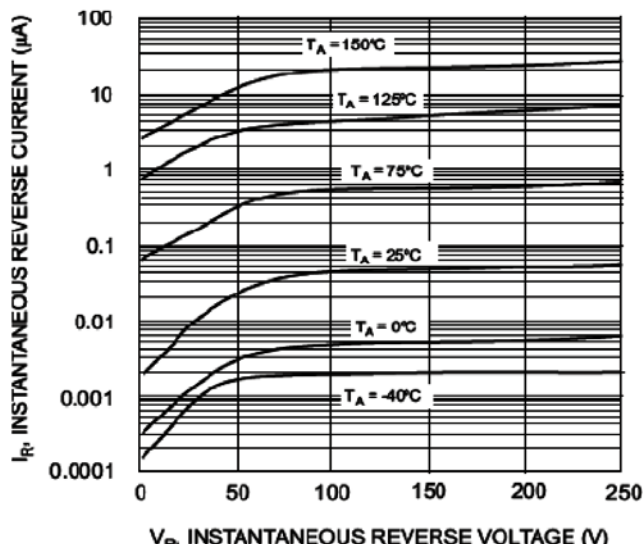

Fig. 2 Typical Reverse Characteristics

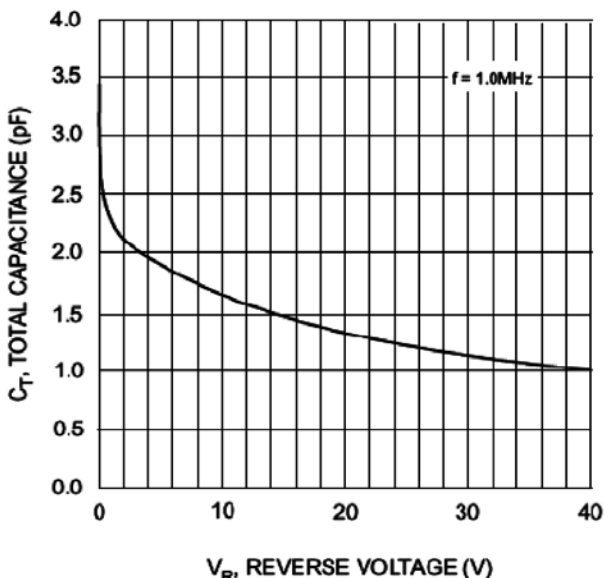

Fig. 3 Typical Capacitance vs. Reverse Voltage

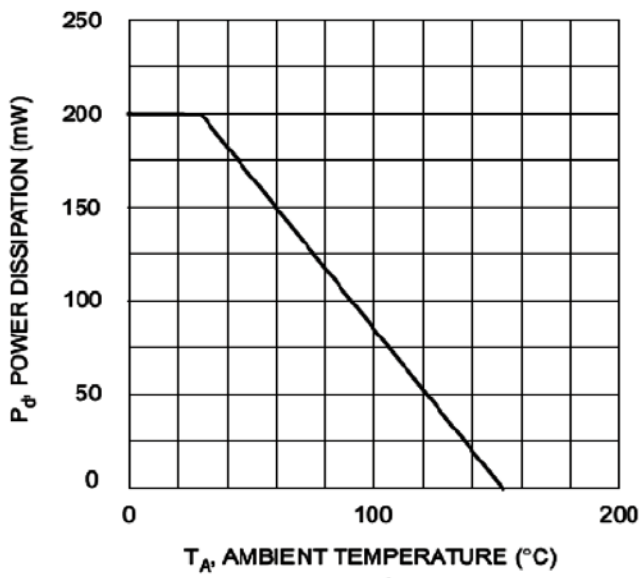

Fig. 4 Power Derating Curve, Total Package



Silicon Epitaxial Planar Diode



Plastic surface mounted package

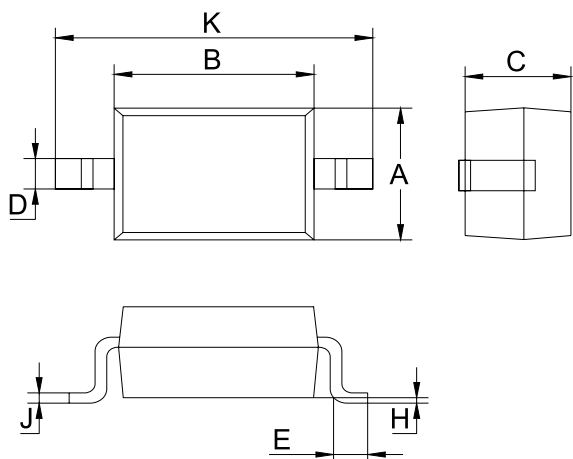

SOD-323		
Dim	Min	Max
A	1.275	1.325
B	1.675	1.725
C	0.9 Typical	
D	0.25	0.35
E	0.27	0.37
H	0.02	0.1
J	0.1 Typical	
K	2.6	2.7
All Dimensions in mm		

Soldering Footprint

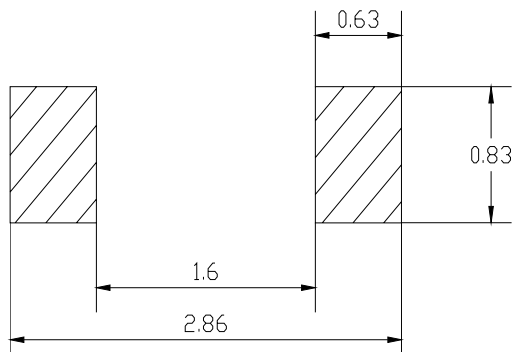

Unit : mm

Package Information

Device	Package	Shipping
BAV21WS-7-F	SOD-323	3,000 / Tape & Reel

Part Number Table

Description	Part Number
Silicon Epitaxial Planar Diode	BAV21WS-7-F

Important Notice : This data sheet and its contents (the "Information") belong to the members of the Premier Farnell group of companies (the "Group") or are licensed to it. No licence is granted for the use of it other than for information purposes in connection with the products to which it relates. No licence of any intellectual property rights is granted. The Information is subject to change without notice and replaces all data sheets previously supplied. The Information supplied is believed to be accurate but the Group assumes no responsibility for its accuracy or completeness, any error in or omission from it or for any use made of it. Users of this data sheet should check for themselves the Information and the suitability of the products for their purpose and not make any assumptions based on information included or omitted. Liability for loss or damage resulting from any reliance on the Information or use of it (including liability resulting from negligence or where the Group was aware of the possibility of such loss or damage arising) is excluded. This will not operate to limit or restrict the Group's liability for death or personal injury resulting from its negligence. Multicomp is the registered trademark of the Group. © Premier Farnell plc 2012.

