

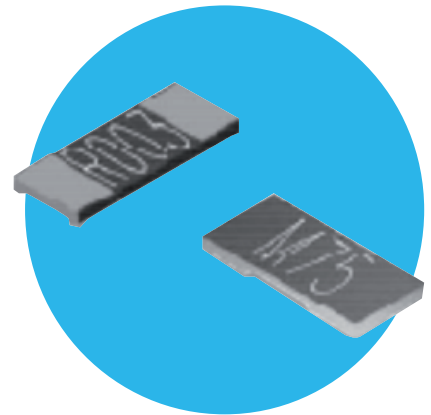

Metal Element Current Sense Resistor

ULR Series

- Robust metal strip able to withstand high temperature and high current.
- Low TCR and Inductance
- Resistance Range from 0.15 mΩ to 22 mΩ
- RoHS compliant
- AEC-Q200
- Higher wattage devices feature PCB clearance gap to maximize thermal performance



 All parts are Pb-free and comply with EU Directive 2011/65/EU (RoHS2)

Electrical Data

Type	Size	Coating	Power Rating @80°C (W)	Standard Resistance Value mΩ ¹	TCR (ppm/°C)	Tolerance (%)	Dielectric Withstanding Voltage (V)	Ambient Temperature (°C)
ULRG1 / ULR1S	1206	None ²	1	0.2, 0.25, 0.3, 0.4, 0.5, 0.6	175	1, 5	N/A	-55 to +170
ULRG15 / ULR15S	2010		1.5	0.2, 0.25, 0.3, 0.4, 0.5 0.75, 1, 2, 3, 4, 5, 6, 7, 8, 9, 10	150			
ULRG1 / ULR1	2512	Green	1	11, 12, 13, 14, 15, 22	50			
ULRG2 / ULR2			2	6.5, 7, 8, 9, 10				
ULRG25 / ULR25			2.5	3.5, 4, 4.5, 5, 5.5, 6				
ULRG3 / ULR3			3	0.15	150			
				0.25, 0.3				
				0.4				
ULRB1 / ULR1		Black	1	0.5, 0.75, 1.5, 2	50			
				2.5, 3, 3.5	150			
				4, 4.5, 5, 5.5, 10	100			
				6, 6.5, 7, 7.5	75			
ULRB2 / ULR2	2	0.5, 0.75, 1, 1.5, 2	50					

Notes: 1. For higher resistance values please refer to LRMA series. 2. Package sizes 1206 and 2010 are uncoated on the top surface and unmarked.

Performance Data

AEC-Q200 ref.	Test	Method		Max. (add R0005)	
				Black & uncoated	Green
3	High Temp. Exposure *	MIL-STD-202 Method 108	ΔR%	1	1
4	Temperature Cycling	JESD22 Method JA-104	ΔR%	0.5	1
6	Moisture Resistance	MIL-STD-202 Method 106	ΔR%	1	1
7	Biased Humidity	MIL-STD-202 Method 103	ΔR%	1	1
8	Operational Life (Cyclic Load) *	MIL-STD-202 Method 108	ΔR%	1	1
14	Vibration	MIL-STD-202 Method 204	ΔR%	0.5	0.5
15	Resistance to Soldering Heat *	MIL-STD-202 Method 210	ΔR%	0.5	1
16	Thermal Shock *	MIL-STD-202 Method 107	ΔR%	0.5	1
18	Solderability	J-STD-002		>95% coverage	
21	Board Flex	AEC-Q200-005	ΔR%	0.5	0.5
22	Terminal Strength	AEC-Q200-006	ΔR%	0.25	0.25
	Short Term Overload *	5 x Pr for 5s	ΔR%	0.5	1

Notes: 1. Full AEC-Q200 qualification applies to 2512 size. The 1206 and 2010 sizes have received the tests marked *.

General Note

TT Electronics reserves the right to make changes in product specification without notice or liability. All information is subject to TT Electronics' own data and is considered accurate at time of going to print.

Physical Data

Dimensions(mm) and weight (mg)								
Size	Coating	Values	L (±0.25)	W	T (±0.2)	D	Wt (nom)	
1206	None	0.2, 0.25	3.2	1.6 ±0.3	1.0	1.5 ±0.25	25	
		0.3				1.4 ±0.25		
		0.4				1.4 ±0.25		
		0.5, 0.6, 1, 4, 5, 6	3.2	1.6 ±0.1	0.6	1.1 ±0.25	20	
		2, 3, 10				0.6 ±0.25		
		7, 8, 9				0.9 ±0.25		
2010	None	0.2	5.08	2.54 ±0.3	1.0	2.34 ±0.25	50	
		0.25				2.24 ±0.25		
		0.3				2.04 ±0.25		
		0.4	5.08	2.54 ±0.15	0.6	1.84 ±0.25	40	
		0.5, 1, 4, 5				1.84 ±0.25		
		2, 6, 7, 8				1.54 ±0.25		
2512	Green	3	6.35	3.0 ±0.3	1.0	1.04 ±0.25	60	
		9, 10				1.29 ±0.25		
		0.15				2.98 ±0.25		
		0.2				2.88 ±0.25		
		0.25, 3				2.68 ±0.25		
		0.4				2.18 ±0.25		
	0.5 - 0.75	6.35	3.18 ±0.35	1.0	1.93 ±0.75	60		
	1 - 22				0.6			
	0.5				1.4			
	Black	Black	0.75, 2.5	6.35	3.18 ±0.25	0.8	1.0	1.3 ±0.38
			1				0.8	
			1.5				0.65	
			2, 5, 6				0.5	
			3				0.7	
			3.5				0.71	
			4				0.6	
			4.5				0.58	
			5.5, 6.5				0.47	
7			0.45					
10			0.8				1.9 ±0.15	

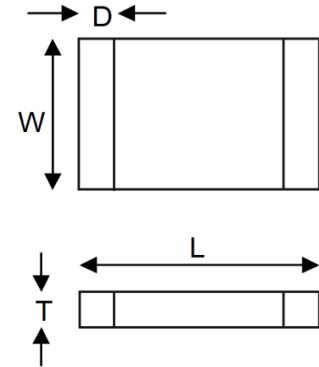

Construction

Black coat

A low TCR resistance alloy plate, with tin plated connection bands is protectively coated on the upper and lower faces and numerically marked with the resistance value. This part is suitable for wave or reflow soldering.

Green coat

A low TCR resistance alloy plate is grooved to set the final resistance, the lower faces are tin plated for connections, and it is protectively coated on the upper and lower faces and numerically marked with the resistance value. This part is ONLY suitable for reflow soldering.

Uncoated

A low TCR resistance alloy plate is grooved to set the final resistance and the lower face only is protected with an epoxy coating. The lower faces are tin plated for connections. This part is ONLY suitable for reflow soldering.

Marking

Only 2512 size parts are marked. For values which are integer numbers of milliohms, the marking is 4-character IEC62 code; e.g. "R002" for 2mΩ, "R010" for 10mΩ. For values including fractions of a milliohm the marking is 3 or 4-character code using "M" to indicate the decimal point, e.g. "M75" for 0.75mΩ, "1M50" for 1.5mΩ.

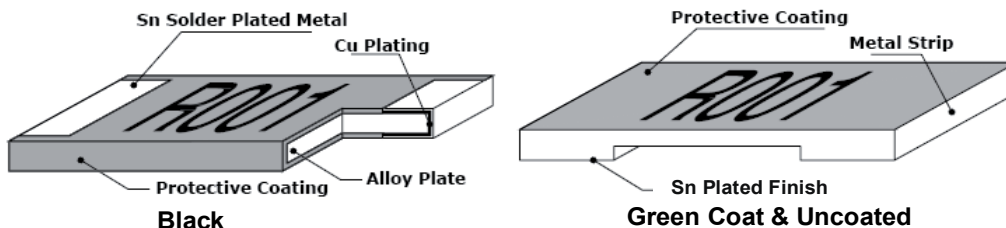

Termination Details:

Material Matt tin plated finish over a barrier layer
Solderability 95% min coverage (MIL-STD 202F / 208H, 235°C 2 secs)

General Note

TT Electronics reserves the right to make changes in product specification without notice or liability.
 All information is subject to TT Electronics' own data and is considered accurate at time of going to print.

Electrical Connections

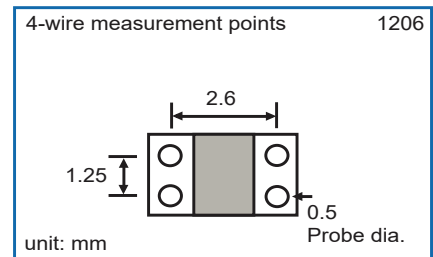
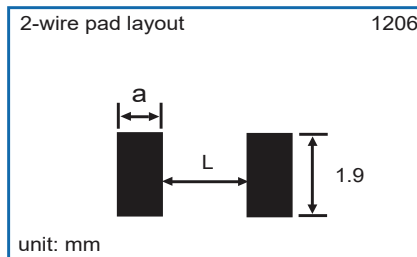
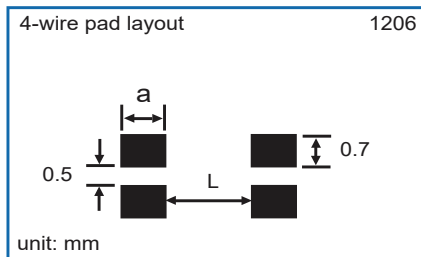
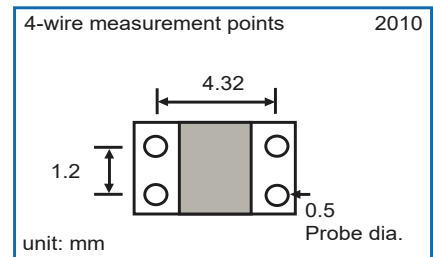
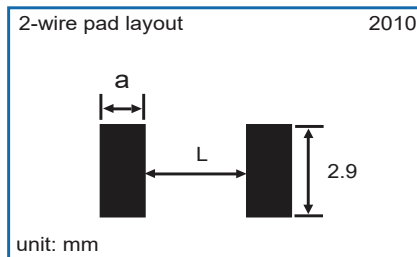
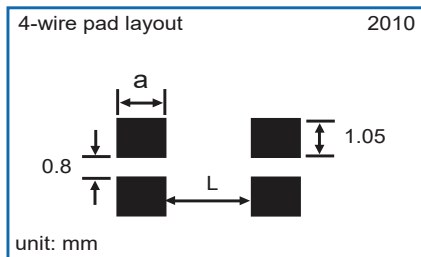
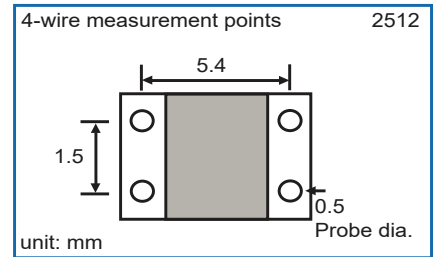
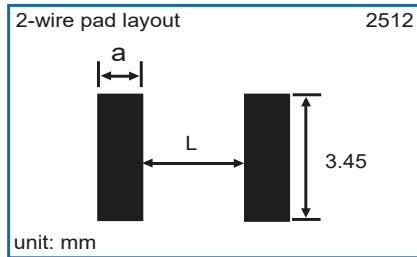
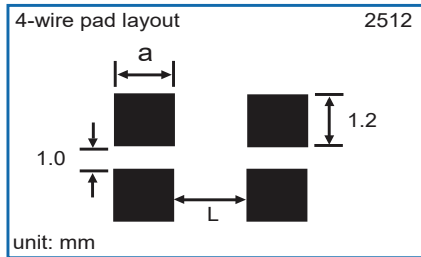

Package	Resistance (mΩ)	a	L
1206	0.5, 0.6	1.55	0.55
	1, 4 - 6	1.55	0.55
	2 - 3, 10	1.05	1.55
	7 - 9	1.35	0.95
2010	0.5, 1, 4 - 5	2.29	0.95
	2, 6 - 8	1.99	1.55
	3	1.49	2.55
9 - 10	1.74	2.05	
2512 - Black	All	2.7	2.9
2512 - Green	0.5	3.13	0.52
	0.75	2.93	0.94
	1	2.38	2.04
	1.5	1.88	3.04
	2 - 3	1.63	3.54
	4, 4.5	2.63	1.54
	5 - 6	2.38	2.04
6.5, 7	1.88	3.04	
8 - 22	1.63	3.54	

Package	Resistance (mΩ)	a	b	c	d	e	f
1206	0.2 - 0.4	0.75	1.9	0.6	0.6	2.15	0.4
2010	0.2 - 0.4	1.35	2.89	0.6	0.6	3.08	1.4
2512 - Green	0.15 - 0.3	2	3.4	0.6	0.6	2.8	1.0
	0.4	1.5	3.4	0.6	0.6	3.8	2.0

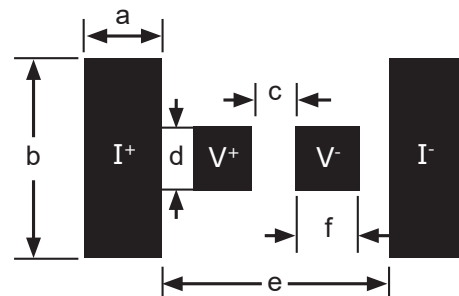

General Note

TT Electronics reserves the right to make changes in product specification without notice or liability.
All information is subject to TT Electronics' own data and is considered accurate at time of going to print.

Suggested Alternative 4-Wire Design Methods

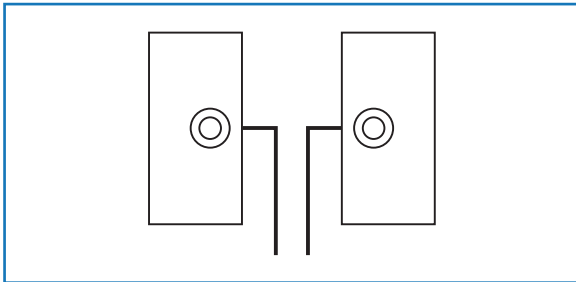

Vias with copper traces on internal layers.

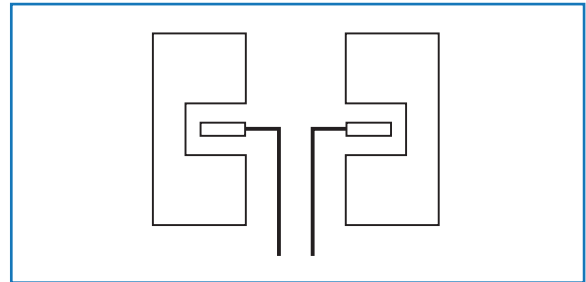

Sense traces on Solder pads beneath the chip

Power Derating Curve

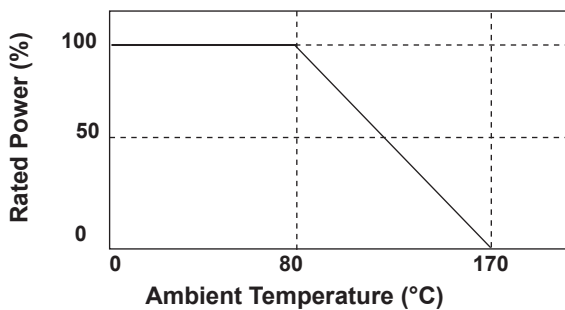

Note:

The power derating curve is a guidance based on a conservative design model. The ULR is a solid metal alloy construction that can withstand significantly greater operating temperatures than the conservative model permits. The protective coating will operate up to 260°C and the alloy can withstand in excess of 350°C. Therefore, the system thermal design will be a more significant design parameter due to the heat limitations of the solder joint.

Plastic tape Specification

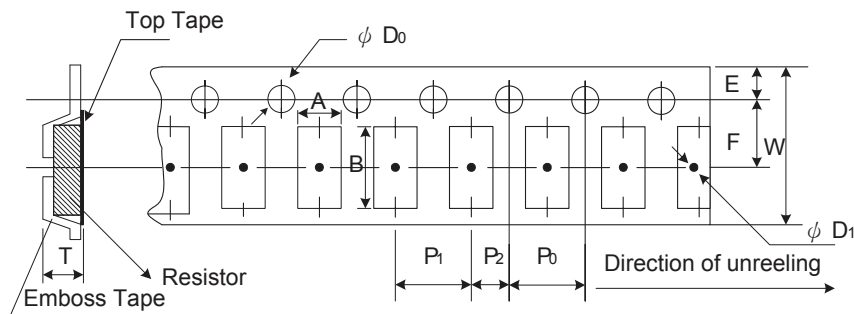

Type	Resistance (mΩ)	A	B	W	E	F	P ₀	P ₁	P ₂	ΦD ₀	ΦD ₁	T	Quantity (EA)
1206	1 -10	1.90 ± 0.1	3.60 ± 0.1	8.0 ± 0.2	1.75 ± 0.1	3.5 ± 0.05	4.0 ± 0.1	4.0 ± 0.1	2.0 ± 0.05	1.55 ± 0.05	1.0min.	0.87 ± 0.1	2,000
2010	1 -10	2.85 ± 0.1	5.55 ± 0.1	12.0 ± 0.2	1.75 ± 0.1	5.5 ± 0.05	4.0 ± 0.1	4.0 ± 0.1	2.0 ± 0.05	1.55 ± 0.05	1.4min	0.85 ± 0.1	2,000
2512 Black	0.50 - 0.75	3.40 ± 0.1	6.75 ± 0.1	12.0 ± 0.1	1.75 ± 0.1	5.5 ± 0.05	4.0 ± 0.1	4.0 ± 0.1	2.0 ± 0.05	1.55 ± 0.05	1.4min	1.45 ± 0.2	2,000
	1 - 10											0.81 ± 0.1	
2512 Green	0.50 -15	3.40 ± 0.1	6.75 ± 0.1	12.0 ± 0.1	1.75 ± 0.1	5.5 ± 0.05	4.0 ± 0.1	4.0 ± 0.1	2.0 ± 0.05	1.55 ± 0.05	1.4min	0.81 ± 0.1	2,000

Note:

1. The cumulative tolerance of 10 sprocket hole pitch is ± 0.2 mm.
2. Carrier camber shall not be more than 1 mm per 100 mm through a length of 250 mm.
3. A & B measured 0.3 mm from the bottom of the packet.
4. T measured at a point on the inside bottom of the packet to the top surface of the carrier.
5. Pocket position relative to sprocket hole is measured as the true position of the pocket and not the pocket hole.

General Note

TT Electronics reserves the right to make changes in product specification without notice or liability. All information is subject to TT Electronics' own data and is considered accurate at time of going to print.

Ordering Procedure

This product has two valid part numbers:

European (Welwyn) Part Number: ULR2-R0015FT2 (2512, 1.5 milliohms $\pm 1\%$, Pb-free)

U	L	R	2	-	R	0	0	1	5	F	T	2	
1				2				3	4				

1	2	3	4
Type	Value	Tolerance	Packing
ULR1S	4 - 6 characters	F = $\pm 1\%$	T2 = Plastic tape
ULR1	R = ohms	J = $\pm 5\%$	All sizes 2000/reel
ULR15S			
ULR2			
ULR25			
ULR3			

USA (IRC) Part Number: ULRB22512R0015FLFSLT (2512, 1.5 milliohms $\pm 1\%$, Pb-free)

U	L	R	B	2	2	5	1	2	R	0	0	1	5	F	L	F	S	L	T
1				2				3				4	5	6					

1	2	3	4	5	6
Type	Size	Value	Tolerance	Termination	Packing
ULRG1	1206	4 - 6 characters	F = $\pm 1\%$	LF = Pb-free	SLT = Plastic tape
ULRG15	2010	R = ohms	J = $\pm 5\%$		All sizes 2000/reel
ULRG2	2512				
ULRG25					
ULRG3					
ULRB1					
ULRB2					

General Note

TT Electronics reserves the right to make changes in product specification without notice or liability.
All information is subject to TT Electronics' own data and is considered accurate at time of going to print.

Mouser Electronics

Authorized Distributor

Click to View Pricing, Inventory, Delivery & Lifecycle Information:

TT Electronics:

[ULRB12512R0075FLFSLT](#) [ULRG22512R010FLFSLT](#) [ULRG22512R009FLFSLT](#) [ULRG22512R008FLFSLT](#)
[ULRG22512R007FLFSLT](#) [ULRB22512R002FLFSLT](#) [ULRB22512R0015FLFSLT](#) [ULRB22512R001FLFSLT](#)
[ULRB12512R003FLFSLT](#) [ULRB12512R0005FLFSLT](#) [ULRB12512R001FLFSLT](#) [ULRB12512R0015FLFSLT](#)
[ULRB22512R0005FLFSLT](#) [ULRB12512R0025FLFSLT](#) [ULRB12512R004FLFSLT](#) [ULRB12512R005FLFSLT](#)
[ULRB12512R007FLFSLT](#) [ULRB12512R006FLFSLT](#) [ULRB12512R002FLFSLT](#) [ULRG32512R001FLFSLT](#)
[ULRG32512R003FLFSLT](#) [ULRG32512R0005FLFSLT](#) [ULRG252512R004FLFSLT](#) [ULRG252512R005FLFSLT](#)
[ULRG252512R006FLFSLT](#) [ULRG32512R0015FLFSLT](#) [ULRG32512R002FLFSLT](#) [ULRG32512R0025FLFSLT](#)
[ULR1R002JLF](#) [ULR1R003JLF](#) [ULR1R0015JLF](#) [ULR1R001JLF](#) [ULR1R004FLFTR](#) [ULR1R005FLFTR](#)
[ULR3R003FLFTR](#) [ULR25R005FLFTR](#) [ULR2R010FLFTR](#) [ULR2R009FLFTR](#) [ULR3R002FLFTR](#) [ULR1R001FLFTR](#)
[ULR2R008FLFTR](#) [ULR1R0015FLFTR](#) [ULR3R001FLFTR](#) [ULR1R0005FLFTR](#) [ULR2R001FLFTR](#) [ULR1R0075FLFTR](#)
[ULR1R0025FLFTR](#) [ULR1R006FLFTR](#) [ULR3R0005FLFTR](#) [ULR25R004FLFTR](#) [ULR2R0005FLFTR](#)
[ULR2R0075FLFTR](#) [ULR2R0015FLFTR](#) [ULR2R002FLFTR](#) [ULR3R0015FLFTR](#) [ULR3R0075FLFTR](#)
[ULR25R0035FLFTR](#) [ULR3R0025FLFTR](#) [ULR1R007LFTR](#) [ULR25R006FLFTR](#) [ULR2R007FLFTR](#) [ULR1R002FLFTR](#)
[ULR1R003FLFTR](#) [ULR2R00075FLFTR](#) [ULR3R00075FLFTR](#) [ULR1R007FLFTR](#) [ULRB22512R00075FLFSLT](#)
[ULRG252512R0035FLFSLT](#) [ULRG32512R00075FLFSLT](#) [ULR1S-R002FT2](#) [ULR2-R008FT2](#) [ULR2-R01FT2](#) [ULR3-](#)
[R0005FT2](#) [ULR1S-R003FT2](#) [ULR1-R001FT2](#) [ULR3-R001FT2](#) [ULR2-R002FT2](#) [ULR1S-R007FT2](#) [ULR1S-R01FT2](#)
[ULR3-R0015FT2](#) [ULR15S-R002FT2](#) [ULR2-R0015FT2](#) [ULR1S-R008FT2](#) [ULR1-R006FT2](#) [ULR1S-R005FT2](#) [ULR3-](#)
[R003FT2](#) [ULR3-R002FT2](#) [ULR1-R005FT2](#) [ULR1-R003FT2](#) [ULR15S-R005FT2](#) [ULR25-R004FT2](#) [ULR1S-R001FT2](#)
[ULR25-R006FT2](#) [ULR15S-R006FT2](#) [ULR25-R005FT2](#) [ULR1S-R006FT2](#) [ULR1S-R0055FT2](#) [ULR15S-R004FT2](#)
[ULR15S-R0055FT2](#)