

FSTD16450

Configurable 4-Bit to 20-Bit Bus Switch with Selectable Level Shifting

General Description

The Fairchild Universal Bus Switch FSTD16450 provides 4-bit, 5-bit, 8-bit, 10-bit, 16-bit, 20-bit of high-speed CMOS TTL-compatible bus switching. The low on resistance of the switch allows inputs to be connected to outputs without adding propagation delay or generating additional ground bounce noise.

The FSTD16450 is designed to allow "customer" configuration control of the enable connections. The device is organized as either a 4-bit, 5-bit, 10-bit or 20-bit bus switch. 8-bit and 16-bit configurations are also achievable (see Functional Description). The device's bit configuration is chosen through select pin logic. (see Truth Table). When \overline{OE}_x is LOW, Port A_x is connected to Port B_x . When \overline{OE}_x is HIGH, the switch is OPEN.

Another key device feature is the addition of a level shifting select pin, "S₂". When S₂ is LOW, the device behaves as a standard N-MOS switch. When S₂ is HIGH, a diode to V_{CC} is integrated into the circuit allowing for level shifting between 5V inputs and 3.3V outputs.

Features

- 4Ω switch connection between two ports
- Voltage level shifting
- Minimal propagation delay through the switch
- Low I_{CC}
- Zero bounce in flow-through mode
- Control inputs compatible with TTL level
- Also packaged in plastic Fine-Pitch Ball Grid Array (FBGA) (Preliminary)

Applications Note

Select pins S₀, S₁, S₂ are intended to be used as static user configurable control pins. The AC performance of these pins has not been characterized or tested. Switching of these select pins during system operation may temporarily disrupt output logic states and/or enable pin controls.

Ordering Code:

Order Number	Package Number	Package Description
FSTD16450GX (Note 1)	BGA54A (Preliminary)	54-Ball Fine-Pitch Ball Grid Array (FBGA), JEDEC MO-205, 5.5mm Wide [Tape and Reel]
FSTD16450MTD	MTD56	56-Lead Thin Shrink Small Outline Package (TSSOP), JEDEC MO-153, 6.1mm Wide

Devices also available in Tape and Reel. Specify by appending the suffix letter "X" to the ordering code.

Note 1: BGA package available in Tape and Reel only.

UHC™ is a trademark of Fairchild Semiconductor Corporation.

FSTD16450 Configurable 4-Bit to 20-Bit Bus Switch with Selectable Level Shifting

Connection Diagrams

Pin Assignments for TSSOP

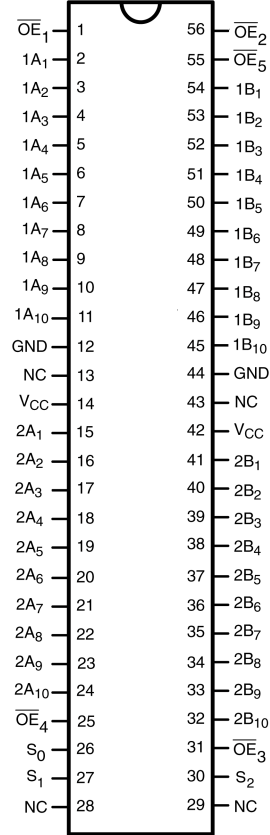

Pin Assignments for FBGA

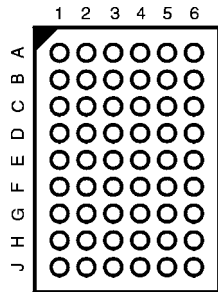

(Top Thru View)

Pin Descriptions

Pin Name	Description
$\overline{OE}_1, \overline{OE}_2$	Bus Switch Enables
1A, 2A	Bus A
1B, 2B	Bus B
S ₀ , S ₁	Bit Configuration Enables
S ₂	Level Shifting Diode Enable

FBGA Pin Assignments

	1	2	3	4	5	6
A	1A ₃	1A ₂	\overline{OE}_1	\overline{OE}_2	1B ₂	1B ₃
B	1A ₅	1A ₄	1A ₁	1B ₁	1B ₄	1B ₅
C	1A ₇	1A ₆	GND	\overline{OE}_5	1B ₆	1B ₇
D	1A ₉	1A ₈	GND	V _{CC}	1B ₈	1B ₉
E	2A ₁	1A ₁₀	S ₀	V _{CC}	1B ₁₀	2B ₁
F	2A ₃	2A ₂	S ₁	S ₂	2B ₂	2B ₃
G	2A ₅	2A ₄	V _{CC}	GND	2B ₄	2B ₅
H	2A ₇	2A ₆	2A ₁₀	2B ₁₀	2B ₆	2B ₇
J	2A ₉	2A ₈	\overline{OE}_4	\overline{OE}_3	2B ₈	2B ₉

Logic Diagrams

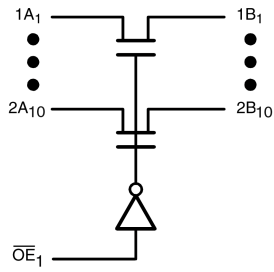

**20-Bit Configuration
(Configuration 1)**

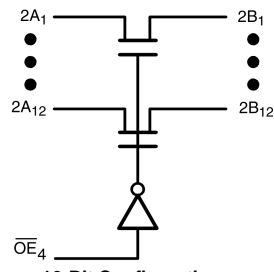
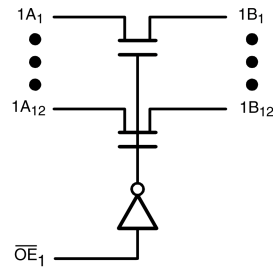

**10-Bit Configuration
(Configuration 2)**

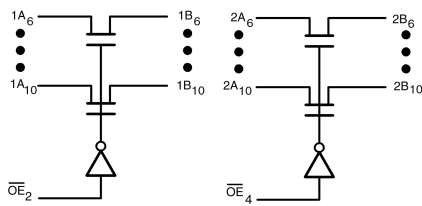
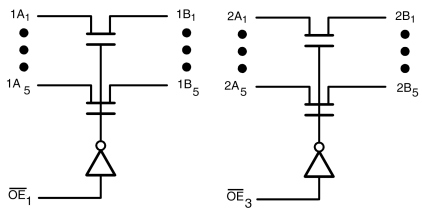

**5-Bit Configuration
(Configuration 3)**

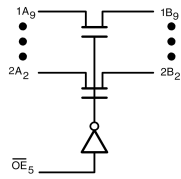
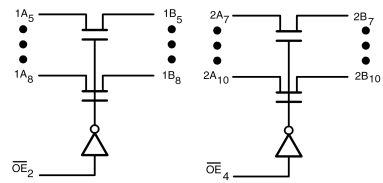
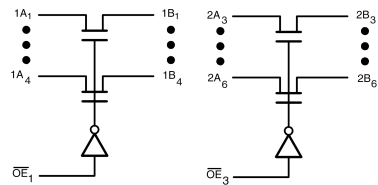

**4-Bit Configuration
(Configuration 4)**

Functional Description

The device can also be configured as an 8 and 16-bit device by grounding the unused pins in Configurations 2 and 1 respectively. The 8-bit configuration may also be achieved by tying two of the 4-bit enables from configuration together and tying the remaining enable pin (OE) HIGH.

Truth Tables (X = V_{CC} or GND)

(see Functional Description)

Select Pin	
S ₂	Mode
L	Std. NMOS Switch
H	Level Shifting Diode Enabled

Configuration 1		S ₀ = S ₁ = L			20-Bit Configuration	
Inputs					Inputs/Outputs	
OE ₁	OE ₂	OE ₃	OE ₄	OE ₅		
L	X	X	X	X	1A ₁₋₁₀ = 1B ₁₋₁₀ , 2A ₁₋₁₀ = 2B ₁₋₁₀	
H	X	X	X	X	Z	

Configuration 2		S ₀ = L, S ₁ = H			10-Bit Configuration	
Inputs					Inputs/Outputs	
OE ₁	OE ₂	OE ₃	OE ₄	OE ₅	1A ₁₋₁₀ = 1B ₁₋₁₀	2A ₁₋₁₀ = 2B ₁₋₁₀
L	X	X	L	X	1A _X = 1B _X	2A _X = 2B _X
L	X	X	H	X	1A _X = 1B _X	Z
H	X	X	L	X	Z	2A _X = 2B _X
H	X	X	H	X	Z	Z

Configuration 3		S ₀ = H, S ₁ = L			5-Bit Configuration			
Inputs					Inputs/Outputs			
OE ₁	OE ₂	OE ₃	OE ₄	OE ₅	1A ₁₋₅ , 1B ₁₋₅	1A ₆₋₁₀ , 1B ₆₋₁₀	2A ₁₋₅ , 2B ₁₋₅	2A ₆₋₁₀ , 2B ₆₋₁₀
L	L	L	L	X	1A _x = 1B _x	1A _y = 1B _y	2A _x = 2B _x	2A _y = 2B _y
L	L	L	H	X	1A _x = 1B _x	1A _y = 1B _y	2A _x = 2B _x	Z
L	L	H	L	X	1A _x = 1B _x	1A _y = 1B _y	Z	2A _y = 2B _y
L	L	H	H	X	1A _x = 1B _x	1A _y = 1B _y	Z	Z
L	H	L	L	X	1A _x = 1B _x	Z	2A _x = 2B _x	2A _y = 2B _y
L	H	L	H	X	1A _x = 1B _x	Z	2A _x = 2B _x	Z
L	H	H	L	X	1A _x = 1B _x	Z	Z	2A _y = 2B _y
L	H	H	H	X	1A _x = 1B _x	Z	Z	Z
H	L	L	L	X	Z	1A _y = 1B _y	2A _x = 2B _x	2A _y = 2B _y
H	L	L	H	X	Z	1A _y = 1B _y	2A _x = 2B _x	Z
H	L	H	L	X	Z	1A _y = 1B _y	Z	2A _y = 2B _y
H	L	H	H	X	Z	1A _y = 1B _y	Z	Z
H	H	L	L	X	Z	Z	2A _x = 2B _x	2A _y = 2B _y
H	H	L	H	X	Z	Z	2A _x = 2B _x	Z
H	H	H	L	X	Z	Z	Z	2A _y = 2B _y
H	H	H	H	X	Z	Z	Z	Z

Truth Tables (Continued)

Configuration 4					4-Bit Configuration				
					$S_0 = S_1 = H$				
Inputs					Inputs/Outputs				
OE ₁	OE ₂	OE ₃	OE ₄	OE ₅	1A ₁₋₄ , 1B ₁₋₄	1A ₅₋₈ , 1B ₅₋₈	2A ₃₋₆ , 2B ₃₋₆	2A ₇₋₁₀ , 2B ₇₋₁₀	1A ₉₋₁₀ , 2B ₉₋₁₀ 2A ₁₋₂ , 2B ₁₋₂
L	L	L	L	L	1A _x = 1B _x	1A _y = 1B _y	2A _x = 2B _x	2A _y = 2B _y	1A _z = 1B _z 2A _z = 2B _z
L	L	L	L	H	1A _x = 1B _x	1A _y = 1B _y	2A _x = 2B _x	2A _y = 2B _y	Z
L	L	L	H	L	1A _x = 1B _x	1A _y = 1B _y	2A _x = 2B _x	Z	1A _z = 1B _z 2A _z = 2B _z
L	L	L	H	H	1A _x = 1B _x	1A _y = 1B _y	2A _x = 2B _x	Z	Z
L	L	H	L	L	1A _x = 1B _x	1A _y = 1B _y	Z	2A _y = 2B _y	1A _z = 1B _z 2A _z = 2B _z
L	L	H	L	H	1A _x = 1B _x	1A _y = 1B _y	Z	2A _y = 2B _y	Z
L	L	H	H	L	1A _x = 1B _x	1A _y = 1B _y	Z	Z	1A _z = 1B _z 2A _z = 2B _z
L	L	H	H	H	1A _x = 1B _x	1A _y = 1B _y	Z	Z	Z
L	H	L	L	L	1A _x = 1B _x	Z	2A _x = 2B _x	2A _y = 2B _y	1A _z = 1B _z 2A _z = 2B _z
L	H	L	L	H	1A _x = 1B _x	Z	2A _x = 2B _x	2A _y = 2B _y	Z
L	H	L	H	L	1A _x = 1B _x	Z	2A _x = 2B _x	Z	1A _z = 1B _z 2A _z = 2B _z
L	H	L	H	H	1A _x = 1B _x	Z	2A _x = 2B _x	Z	Z
L	H	H	L	L	1A _x = 1B _x	Z	Z	2A _y = 2B _y	1A _z = 1B _z 2A _z = 2B _z
L	H	H	L	H	1A _x = 1B _x	Z	Z	2A _y = 2B _y	Z
L	H	H	H	L	1A _x = 1B _x	Z	Z	Z	1A _z = 1B _z 2A _z = 2B _z
L	H	H	H	H	1A _x = 1B _x	Z	Z	Z	Z
H	L	L	L	L	Z	1A _y = 1B _y	2A _x = 2B _x	2A _y = 2B _y	1A _z = 1B _z 2A _z = 2B _z
H	L	L	L	H	Z	1A _y = 1B _y	2A _x = 2B _x	2A _y = 2B _y	Z
H	L	L	H	L	Z	1A _y = 1B _y	2A _x = 2B _x	Z	1A _z = 1B _z 2A _z = 2B _z
H	L	L	H	H	Z	1A _y = 1B _y	2A _x = 2B _x	Z	Z
H	L	H	L	L	Z	1A _y = 1B _y	Z	2A _y = 2B _y	1A _z = 1B _z 2A _z = 2B _z
H	L	H	L	H	Z	1A _y = 1B _y	Z	2A _y = 2B _y	Z
H	L	H	H	L	Z	1A _y = 1B _y	Z	Z	1A _z = 1B _z 2A _z = 2B _z
H	L	H	H	H	Z	1A _y = 1B _y	Z	Z	Z
H	H	L	L	L	Z	Z	2A _x = 2B _x	2A _y = 2B _y	1A _z = 1B _z 2A _z = 2B _z
H	H	L	L	H	Z	Z	2A _x = 2B _x	2A _y = 2B _y	Z
H	H	L	H	L	Z	Z	2A _x = 2B _x	Z	1A _z = 1B _z 2A _z = 2B _z
H	H	L	H	H	Z	Z	2A _x = 2B _x	Z	Z
H	H	H	L	L	Z	Z	Z	2A _y = 2B _y	1A _z = 1B _z 2A _z = 2B _z
H	H	H	L	H	Z	Z	Z	2A _y = 2B _y	Z
H	H	H	H	L	Z	Z	Z	Z	1A _z = 1B _z 2A _z = 2B _z
H	H	H	H	H	Z	Z	Z	Z	Z

Absolute Maximum Ratings (Note 2)

Supply Voltage (V_{CC})	-0.5V to +7.0V
DC Switch Voltage (V_S) (Note 3)	-0.5V to +7.0V
DC Input Control Pin Voltage (V_{IN}) (Note 4)	-0.5V to +7.0V
DC Input Diode Current (I_{IK}) $V_{IN} < 0V$	-50 mA
DC Output (I_{OUT}) Current	128 mA
DC V_{CC}/GND Current (I_{CC}/I_{GND})	+/- 100 mA
Storage Temperature Range (T_{STG})	-65°C to +150 °C

Recommended Operating Conditions (Note 5)

Power Supply Operating (V_{CC})	4.0V to 5.5V
Input Voltage (V_{IN})	0V to 5.5V
Output Voltage (V_{OUT})	0V to 5.5V
Free Air Operating Temperature (T_A)	-40 °C to +85 °C

Note 2: The "Absolute Maximum Ratings" are those values beyond which the safety of the device cannot be guaranteed. The device should not be operated at these limits. The parametric values defined in the Electrical Characteristics tables are not guaranteed at the absolute maximum rating. The "Recommended Operating Conditions" table will define the conditions for actual device operation.

Note 3: V_S is the voltage observed/applied at either the A or B Ports across the switch.

Note 4: The input and output negative voltage ratings may be exceeded if the input and output diode current ratings are observed.

Note 5: Unused control inputs must be held HIGH or LOW. They may not float.

DC Electrical Characteristics

Symbol	Parameter	V_{CC} (V)	$T_A = -40\text{ °C to }+85\text{ °C}$			Units	Conditions
			Min	Typ (Note 6)	Max		
V_{IK}	Clamp Diode Voltage	4.5			-1.2	V	$I_{IN} = -18\text{ mA}$
V_{IH}	HIGH Level Input Voltage	4.0-5.5	2.0			V	IF $S_2 = \text{HIGH}$ $4.5V \leq V_{CC} \leq 5.5V$
V_{IL}	LOW Level Input Voltage	4.0-5.5			0.8	V	IF $S_2 = \text{HIGH}$ $4.5V \leq V_{CC} \leq 5.5V$
V_{OH}	HIGH Level Output Voltage	4.5-5.5	See Figure 3			V	$S_2 = V_{CC}$
I_I	Input Leakage Current	5.5			± 1.0	μA	$0 \leq V_{IN} \leq 5.5V$
		0			10	μA	$V_{IN} = 5.5V$
I_{OZ}	OFF-STATE Leakage Current	5.5			± 1.0	μA	$0 \leq A, B \leq V_{CC}$
R_{ON}	Switch On Resistance (Note 7)	4.5		4	7	Ω	$V_{IN} = 0V, I_{IN} = 64\text{ mA}, S_2 = 0V \text{ or } V_{CC}$
		4.5		4	7	Ω	$V_{IN} = 0V, I_{IN} = 30\text{ mA}, S_2 = 0V \text{ or } V_{CC}$
		4.5		8	12	Ω	$V_{IN} = 2.4V, I_{IN} = 15\text{ mA}, S_2 = 0V$
		4.0		11	20	Ω	$V_{IN} = 2.4V, I_{IN} = 15\text{ mA}, S_2 = 0V$
		4.5		35	50	Ω	$V_{IN} = 2.4V, I_{IN} = 15\text{ mA}, S_2 = V_{CC}$
I_{CC}	Quiescent Supply Current	5.5			3	μA	$S_2 = \text{GND}, V_{IN} = V_{CC} \text{ or } \text{GND}, I_{OUT} = 0$
					10	μA	$S_2 = V_{CC}, \overline{OE}_x = V_{CC}, V_{IN} = V_{CC} \text{ or } \text{GND}, I_{OUT} = 0$
					1.5	mA	$S_2 = V_{CC}, \overline{OE}_x = \text{GND}, V_{IN} = V_{CC} \text{ or } \text{GND}, I_{OUT} = 0$
ΔI_{CC}	Increase in I_{CC} per Input	5.5			2.5	mA	One Input at 3.4V Other Inputs at V_{CC} or GND, $S_2 = 0V$
					4.0	mA	One Input at 3.4V Other Inputs at V_{CC} or GND, $S_2 = V_{CC}$

Note 6: Typical values are at $V_{CC} = 5.0V$ and $T_A = +25\text{ °C}$

Note 7: Measured by the voltage drop between A and B pins at the indicated current through the switch. On Resistance is determined by the lower of the voltages on the two (A or B) pins.

AC Electrical Characteristics								
Symbol	Parameter	$T_A = -40\text{ }^\circ\text{C to } +85\text{ }^\circ\text{C}$, $C_L = 50\text{pF}$, $R_U = R_D = 500\Omega$				Units	Conditions ($S_2 = 0V$)	Figure Number
		$V_{CC} = 4.5 - 5.5V$		$V_{CC} = 4.0V$				
		Min	Max	Min	Max			
t_{PHL} , t_{PLH}	Propagation Delay Bus-to-Bus (Note 8)		0.25		0.25	ns	$V_I = \text{OPEN}$	Figures 1, 2
t_{PZH} , t_{PZL}	Output Enable Time	1.5	6.5		7.0	ns	$V_I = 7V$ for t_{PZL} $V_I = \text{OPEN}$ for t_{PZH}	Figures 1, 2
t_{PHZ} , t_{PLZ}	Output Disable Time	1.5	6.7		7.2	ns	$V_I = 7V$ for t_{PLZ} $V_I = \text{OPEN}$ for t_{PHZ}	Figures 1, 2
t_{PZH} , t_{PZL}	$S_{el}(S_0, 1)$ to Output Enable Time	1.5	7.0		7.5	ns	$V_I = 7V$ for t_{PZL} $V_I = \text{OPEN}$ for t_{PZH}	Figures 1, 2
t_{PHZ} , t_{PLZ}	$S_{el}(S_0, 1)$ to Output Disable Time	1.5	7.5		7.7	ns	$V_I = 7V$ for t_{PLZ} $V_I = \text{OPEN}$ for t_{PHZ}	Figures 1, 2
<p>Note 8: This parameter is guaranteed by design but is not tested. The bus switch contributes no propagation delay other than the RC delay of the typical On Resistance of the switch and the 50pF load capacitance, when driven by an ideal voltage source (zero output impedance).</p>								
AC Electrical Characteristics: Translating Diode								
Symbol	Parameter	$T_A = -40\text{ }^\circ\text{C to } +85\text{ }^\circ\text{C}$, $C_L = 50\text{pF}$, $R_U = R_D = 500\Omega$		Units	Conditions ($S_2 = V_{CC}$)	Figure Number		
		$V_{CC} = 4.5 - 5.5V$						
		Min	Max					
t_{PHL} , t_{PLH}	Propagation Delay Bus-to-Bus (Note 9)		0.25	ns	$V_I = \text{OPEN}$	Figures 1, 2		
t_{PZH} , t_{PZL}	Output Enable Time	1.5	10.0	ns	$V_I = 7V$ for t_{PZL} $V_I = \text{OPEN}$ for t_{PZH}	Figures 1, 2		
t_{PHZ} , t_{PLZ}	Output Disable Time	1.5	9.0	ns	$V_I = 7V$ for t_{PLZ} $V_I = \text{OPEN}$ for t_{PHZ}	Figures 1, 2		
t_{PZH} , t_{PZL}	$S_{el}(S_0, 1)$ to Output Enable Time	1.5	11.0	ns	$V_I = 7V$ for t_{PZL} $V_I = \text{OPEN}$ for t_{PZH}	Figures 1, 2		
t_{PHZ} , t_{PLZ}	$S_{el}(S_0, 1)$ to Output Disable Time	1.5	10.0	ns	$V_I = 7V$ for t_{PLZ} $V_I = \text{OPEN}$ for t_{PHZ}	Figures 1, 2		
<p>Note 9: This parameter is guaranteed by design but is not tested. This bus switch contributes no propagation delay other than the RC delay of the typical On Resistance of the switch and the 50pF load capacitance, when driven by an ideal voltage source (zero output impedance).</p>								
Capacitance (Note 10)								
Symbol	Parameter	Typ	Max	Units	Conditions			
C_{IN}	Control Pin Input Capacitance	4		pF	$V_{CC} = 5.0V$, $V_{IN} = 0V$			
$C_{I/O}$	Input/Output Capacitance "OFF State"	8		pF	$V_{CC}, \overline{OE} = 5.0V$, $V_{IN} = 0V$			
<p>Note 10: $T_A = +25\text{ }^\circ\text{C}$, $f = 1\text{ MHz}$, Capacitance is characterized but not tested.</p>								

AC Loading and Waveforms

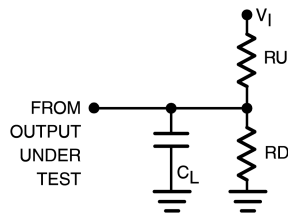

Note: Input driven by 50Ω source terminated in 50Ω
Note: C_L includes load and stray capacitance
Note: Input Frequency = 1.0 MHz, $t_W = 500$ ns

FIGURE 1. AC Test Circuit

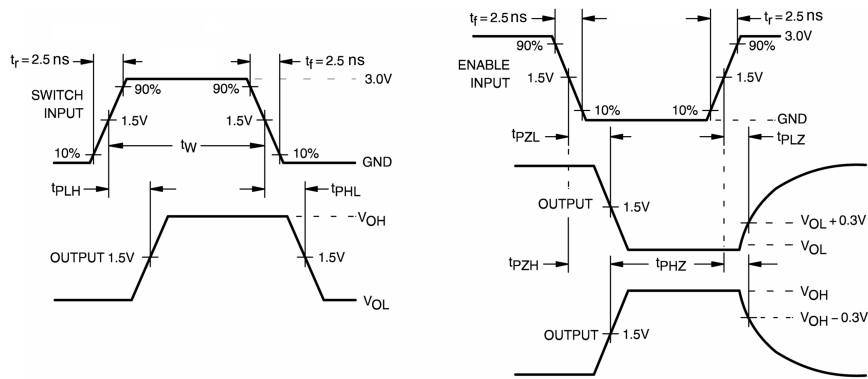

FIGURE 2. AC Waveforms

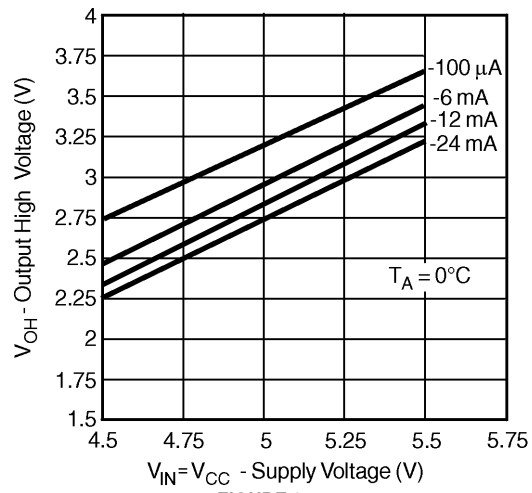
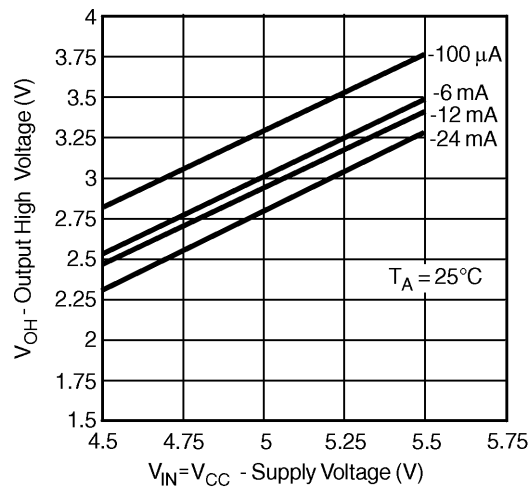
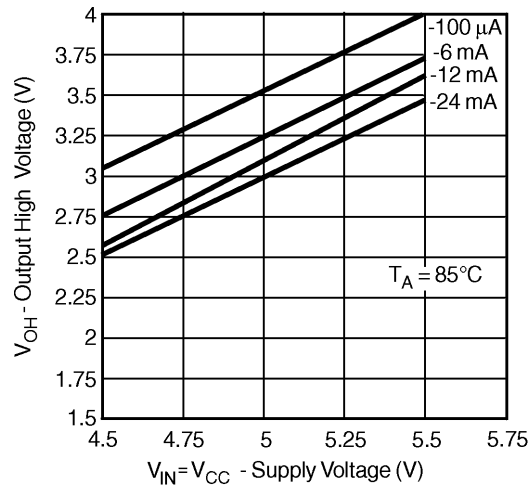
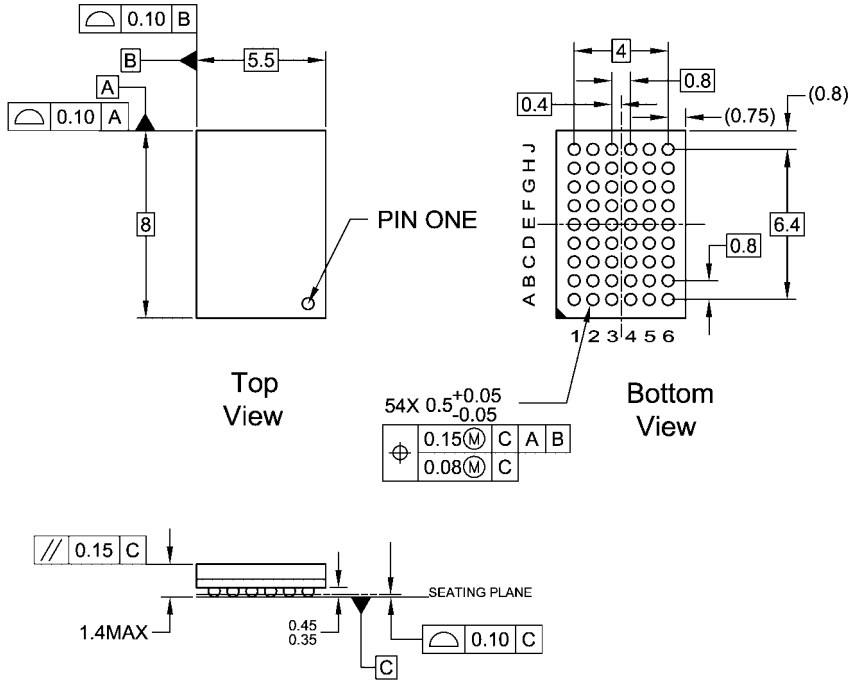

FIGURE 3.

Physical Dimensions inches (millimeters) unless otherwise noted



NOTES:

- A. THIS PACKAGE CONFORMS TO JEDEC M0-205
- B. ALL DIMENSIONS IN MILLIMETERS
- C. LAND PATTERN RECOMMENDATION: NSMD (Non Solder Mask Defined)
.35MM DIA PADS WITH A SOLDERMASK OPENING OF .45MM CONCENTRIC TO PADS
- D. DRAWING CONFORMS TO ASME Y14.5M-1994

BGA54ArevD

54-Ball Fine-Pitch Ball Grid Array (FBGA), JEDEC MO-205, 5.5mm Wide
Package Number BGA54A
Preliminary

Physical Dimensions inches (millimeters) unless otherwise noted (Continued)

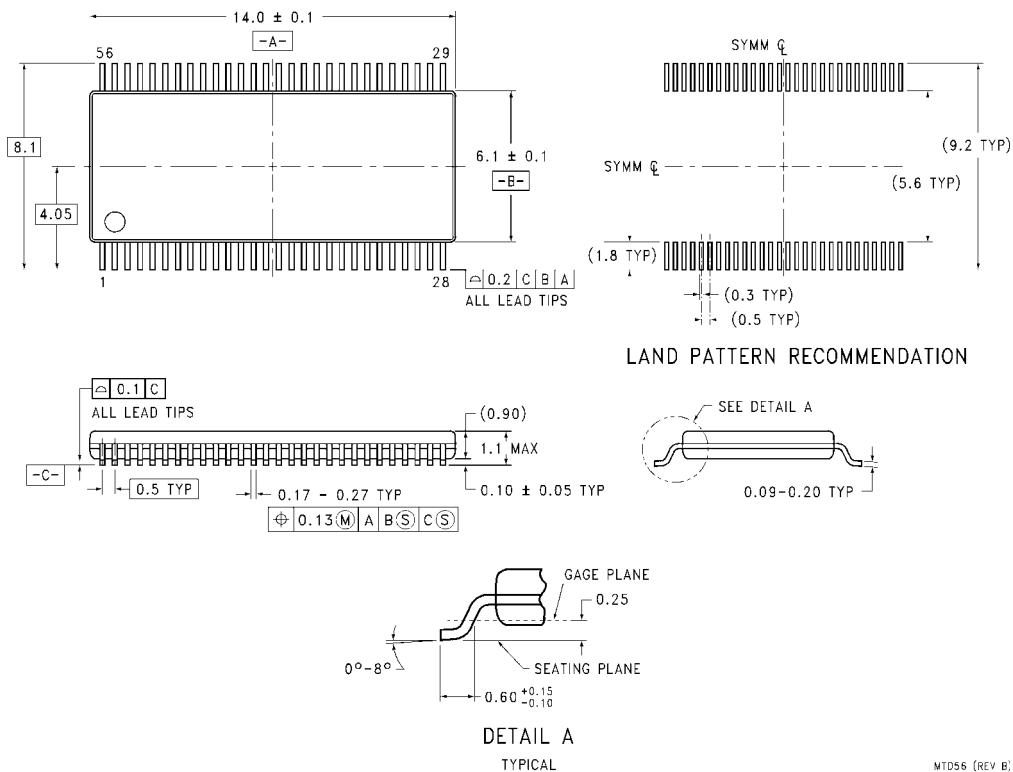

**56-Lead Thin Shrink Small Outline Package (TSSOP), JEDEC MO-153, 6.1mm Wide
Package Number MTD56**

Technology Description

The Fairchild Switch family derives from and embodies Fairchild's proven switch technology used for several years in its 74LVX3L384 (FST3384) bus switch product.

Fairchild does not assume any responsibility for use of any circuitry described, no circuit patent licenses are implied and Fairchild reserves the right at any time without notice to change said circuitry and specifications.

LIFE SUPPORT POLICY

FAIRCHILD'S PRODUCTS ARE NOT AUTHORIZED FOR USE AS CRITICAL COMPONENTS IN LIFE SUPPORT DEVICES OR SYSTEMS WITHOUT THE EXPRESS WRITTEN APPROVAL OF THE PRESIDENT OF FAIRCHILD SEMICONDUCTOR CORPORATION. As used herein:

1. Life support devices or systems are devices or systems which, (a) are intended for surgical implant into the body, or (b) support or sustain life, and (c) whose failure to perform when properly used in accordance with instructions for use provided in the labeling, can be reasonably expected to result in a significant injury to the user.
2. A critical component in any component of a life support device or system whose failure to perform can be reasonably expected to cause the failure of the life support device or system, or to affect its safety or effectiveness.

www.fairchildsemi.com