

MOSFET – P-Channel, Shielded Gate, POWERTRENCH®

-150 V, -2.2 A, 255 mΩ

FDS86267P

General Description

This P-Channel MOSFET is produced using **onsemi**'s advanced POWERTRENCH process that incorporates shielded gate technology. The process has been optimized for the on-state resistance and yet maintain superior switching performance.

Features

- Shielded Gate MOSFET Technology
- Max $R_{DS(ON)} = 255 \text{ m}\Omega$ @ $V_{GS} = -10 \text{ V}$, $I_D = -2.2 \text{ A}$
- Max $R_{DS(ON)} = 290 \text{ m}\Omega$ @ $V_{GS} = -6 \text{ V}$, $I_D = -2 \text{ A}$
- Very Low $R_{DS(on)}$ Mid Voltage P-channel Silicon Technology Optimised for Low Qg
- This Product is Optimised for Fast Switching Applications as well as Load Switch Applications
- 100% UIL Tested
- This Device is Pb-Free, Halide Free and is RoHS Compliant

Applications

- Active Clamp Switch
- Load Switch

V_{DS}	$R_{DS(on)}$ MAX	I_D MAX
-150 V	255 mΩ @ -10 V	-2.2 A
	290 mΩ @ -6 V	

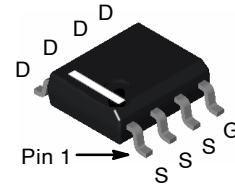

SOIC8
 CASE 751EB

MARKING DIAGRAM

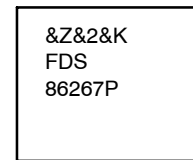

- &Z = Assembly Plant Code
- &2 = 2-Digit Date Code (Year & Week)
- &K = 2-Digit Lot Run Traceability Code
- FDS86267P = Specific Device Code

PIN CONNECTIONS

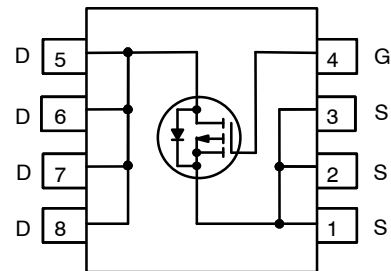

ORDERING INFORMATION

Device	Package	Shipping†
FDS86267P	SOIC8	2500 / Tape & Reel

†For information on tape and reel specifications, including part orientation and tape sizes, please refer to our Tape and Reel Packaging Specification Brochure, [BRD8011/D](#).

FDS86267P

ABSOLUTE MAXIMUM RATINGS (T_A = 25°C unless otherwise noted)

Symbol	Parameter	Ratings	Unit
V _{DS}	Drain to Source Voltage	-150	V
V _{GS}	Gate to Source Voltage	±25	V
I _D	Drain Current	Continuous (Note 1a)	-2.2
		Pulsed (Note 4)	-34
E _{AS}	Single Pulse Avalanche Energy (Note 3)	54	mJ
P _D	Power Dissipation	T _A = 25°C (Note 1a)	2.5
		T _A = 25°C (Note 1b)	1.0
T _J , T _{STG}	Operating and Storage Junction Temperature Range	-55 to +150	°C

Stresses exceeding those listed in the Maximum Ratings table may damage the device. If any of these limits are exceeded, device functionality should not be assumed, damage may occur and reliability may be affected.

THERMAL CHARACTERISTICS

Symbol	Parameter	Ratings	Unit
R _{θJA}	Thermal Resistance, Junction to Ambient (Note 1a)	50	°C/W
	Thermal Resistance, Junction to Ambient (Note 1b)	125	

ELECTRICAL CHARACTERISTICS (T_J = 25°C unless otherwise noted)

Symbol	Parameter	Test Condition	Min	Typ	Max	Unit
--------	-----------	----------------	-----	-----	-----	------

OFF CHARACTERISTICS

BV _{DSS}	Drain to Source Breakdown Voltage	I _D = -250 μA, V _{GS} = 0 V	-150	-	-	V
$\frac{\Delta BV_{DSS}}{\Delta T_J}$	Breakdown Voltage Temperature Coefficient	I _D = -250 μA, Referenced to 25°C	-	-121	-	mV/°C
I _{DSS}	Zero Gate Voltage Drain Current	V _{DS} = -120 V, V _{GS} = 0 V	-	-	-1	μA
I _{GSS}	Gate to Source Leakage Current	V _{GS} = ±25 V, V _{DS} = 0 V	-	-	±100	nA

ON CHARACTERISTICS

V _{GS(th)}	Gate to Source Threshold Voltage	V _{GS} = V _{DS} , I _D = -250 μA	-2	-3	-4	V
$\frac{\Delta V_{GS(th)}}{\Delta T_J}$	Gate to Source Threshold Voltage Temperature Coefficient	I _D = -250 μA, Referenced to 25°C	-	5	-	mV/°C
R _{DS(on)}	Static Drain to Source On Resistance	V _{GS} = -10 V, I _D = -2.2 A	-	191	255	mΩ
		V _{GS} = -6 V, I _D = -2 A	-	214	290	
		V _{GS} = -10 V, I _D = -2.2 A, T _J = 125°C	-	342	448	
g _{FS}	Forward Transconductance	V _{DS} = -10 V, I _D = -2.2 A	-	6.8	-	S

DYNAMIC CHARACTERISTICS

C _{iss}	Input Capacitance	V _{DS} = -75 V, V _{GS} = 0 V, f = 1 MHz	-	806	1130	pF
C _{oss}	Output Capacitance		-	54	75	pF
C _{rss}	Reverse Transfer Capacitance		-	1.6	2.3	pF
R _g	Gate Resistance		0.1	3	6	Ω

SWITCHING CHARACTERISTICS

t _{d(on)}	Turn-On Delay Time	V _{DD} = -75 V, I _D = -2.2 A, V _{GS} = -10 V, R _{GEN} = 6 Ω	-	9.7	20	ns
t _r	Rise Time		-	2.5	10	ns
t _{d(off)}	Turn-Off Delay Time		-	17	30	ns
t _f	Fall Time		-	5.7	12	ns

FDS86267P

ELECTRICAL CHARACTERISTICS ($T_J = 25^\circ\text{C}$ unless otherwise noted) (continued)

Symbol	Parameter	Test Condition	Min	Typ	Max	Unit
SWITCHING CHARACTERISTICS						
Q_g	Total Gate Charge	$V_{GS} = 0\text{ V to } -10\text{ V}, V_{DD} = -75\text{ V}, I_D = -2.2\text{ A}$	-	11	16	nC
		$V_{GS} = 0\text{ V to } -6\text{ V}, V_{DD} = -75\text{ V}, I_D = -2.2\text{ A}$	-	7	10	nC
Q_{gs}	Gate to Source Charge	$V_{DD} = -75\text{ V}, I_D = -2.2\text{ A}$	-	3.2	-	nC
Q_{gd}	Gate to Drain "Miller" Charge		-	1.9	-	nC

DRAIN-SOURCE DIODE CHARACTERISTICS

V_{SD}	Source-Drain Diode Forward Voltage	$V_{GS} = 0\text{ V}, I_S = -2.2\text{ A}$ (Note 2)	-	-0.8	-1.3	V
		$V_{GS} = 0\text{ V}, I_S = -2\text{ A}$ (Note 2)	-	-0.8	-1.2	
t_{rr}	Reverse Recovery Time	$I_F = -2.2\text{ A}, di/dt = 100\text{ A}/\mu\text{s}$	-	65	104	ns
Q_{rr}	Reverse Recovery Charge		-	157	251	nC

Product parametric performance is indicated in the Electrical Characteristics for the listed test conditions, unless otherwise noted. Product performance may not be indicated by the Electrical Characteristics if operated under different conditions.

- $R_{\theta JA}$ is determined with the device mounted on a 1 in² pad 2 oz copper pad on a 1.5 × 1.5 in. board of FR-4 material. $R_{\theta JC}$ is guaranteed by design while $R_{\theta CA}$ is determined by the user's board design.

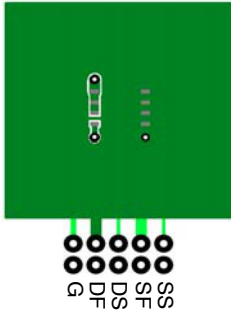

- 50°C/W when mounted on a 1 in² pad of 2 oz copper.

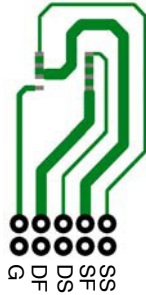

- 125°C/W when mounted on a minimum pad.

- Pulse Test: Pulse Width < 300 μs, Duty cycle < 2.0 %.
- Starting $T_J = 25^\circ\text{C}$, $L = 3\text{ mH}$, $I_{AS} = -6\text{ A}$, $V_{DD} = -150\text{ V}$, $V_{GS} = -10\text{ V}$. 100% tested at $L = 0.3\text{ mH}$, $I_{AS} = -13\text{ A}$.
- Pulsed I_D please refer to Figure 11 SOA graph for more details.

TYPICAL CHARACTERISTICS ($T_J = 25^\circ\text{C}$ unless otherwise noted)

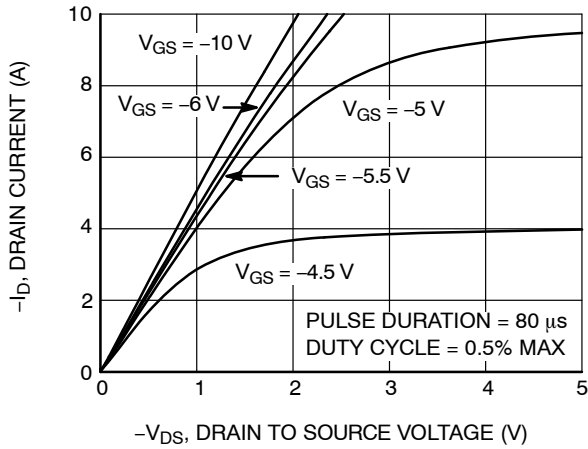

Figure 1. On Region Characteristics

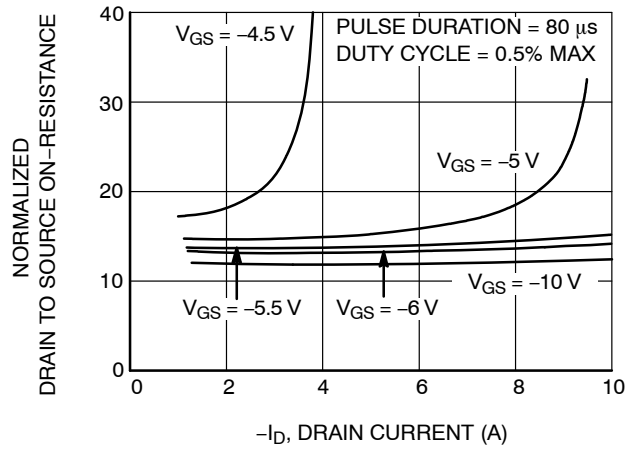

Figure 2. Normalized On-Resistance vs. Drain Current and Gate Voltage

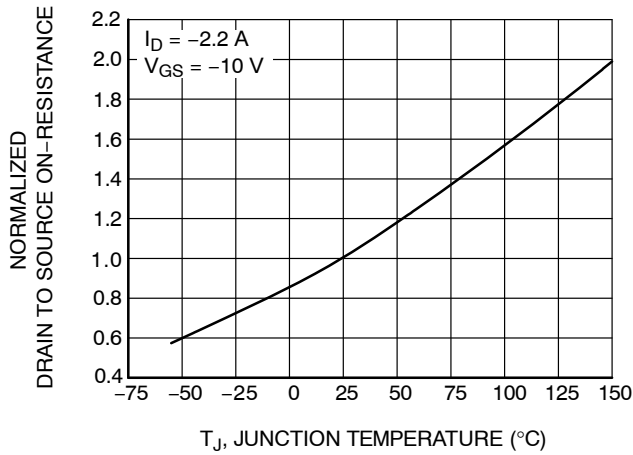

Figure 3. Normalized On Resistance vs. Junction Temperature

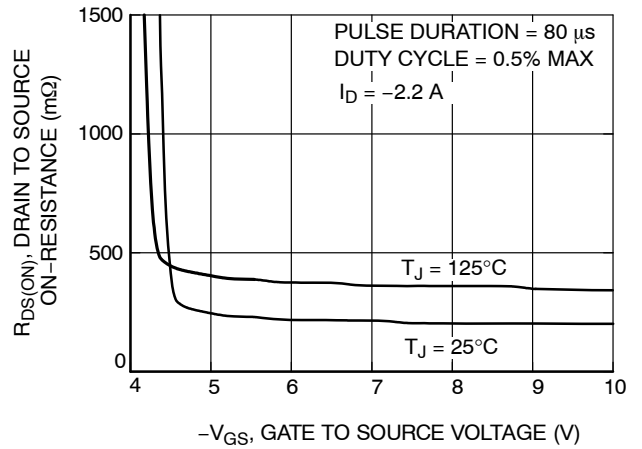

Figure 4. On-Resistance vs. Gate to Source Voltage

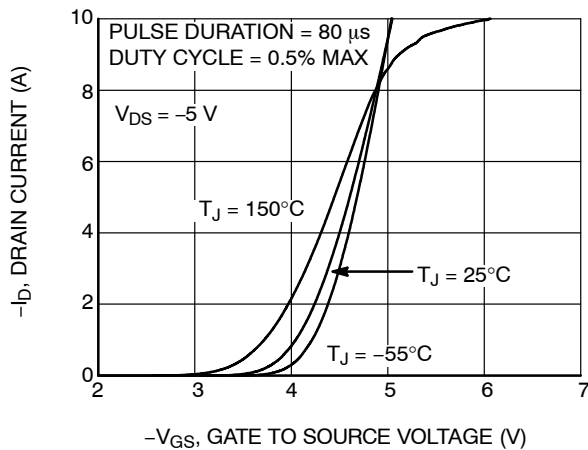

Figure 5. Transfer Characteristics

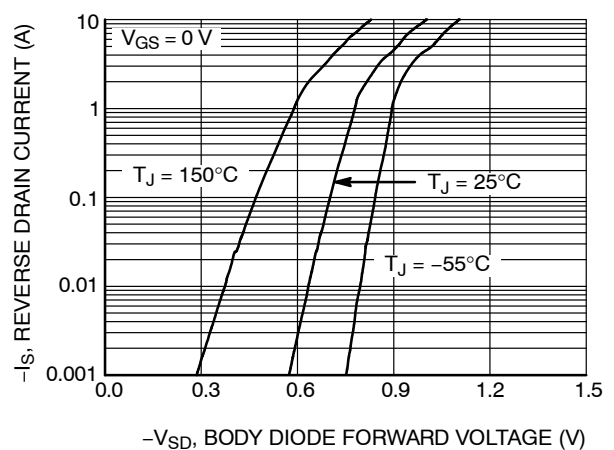

Figure 6. Source to Drain Diode Forward Voltage vs. Source Current

TYPICAL CHARACTERISTICS ($T_J = 25^\circ\text{C}$ unless otherwise noted) (continued)

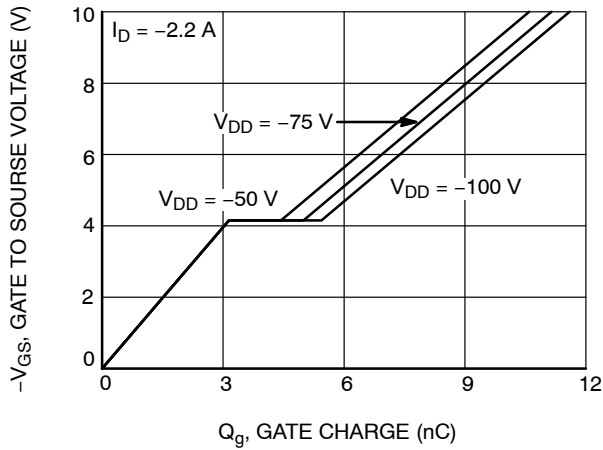

Figure 7. Gate Charge Characteristics

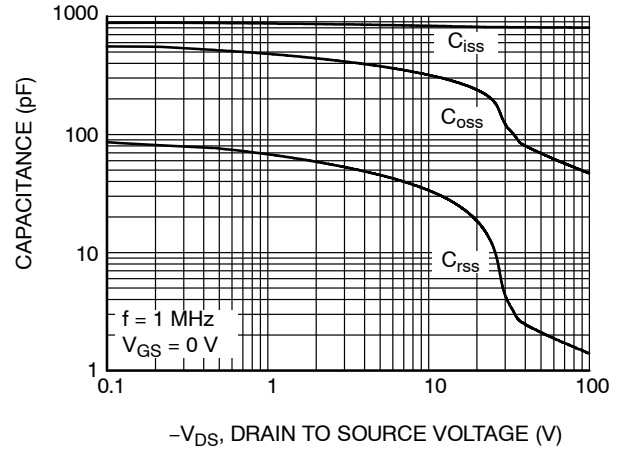

Figure 8. Capacitance vs. Drain to Source Voltage

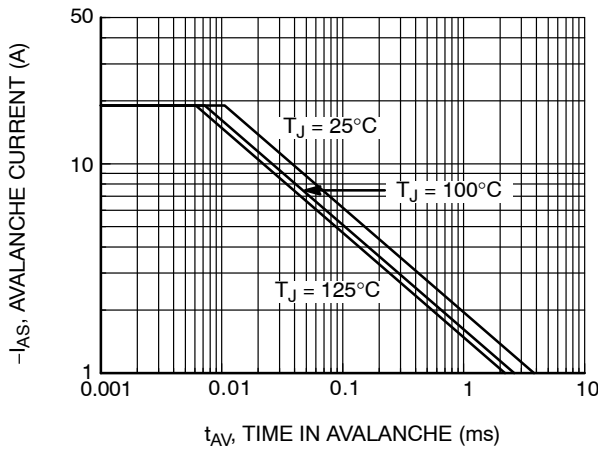

Figure 9. Unclamped Inductive Switching Capability

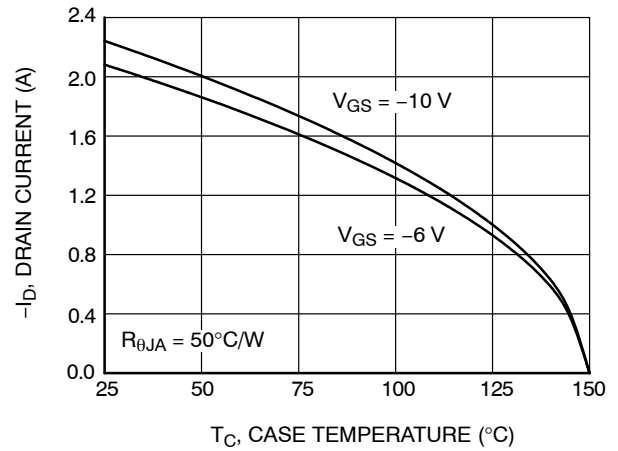

Figure 10. Maximum Continuous Drain Current vs. Ambient Temperature

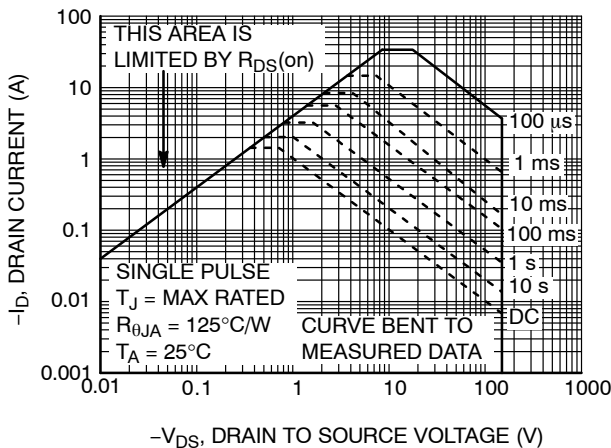

Figure 11. Forward Bias Safe Operating Area

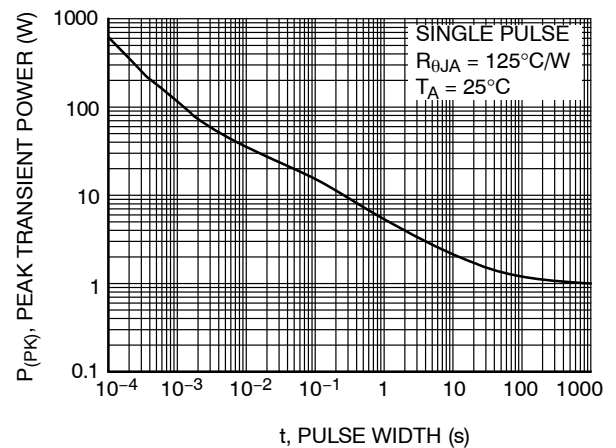

Figure 12. Single Pulse Maximum Power Dissipation

MECHANICAL CASE OUTLINE
PACKAGE DIMENSIONS

ON Semiconductor®



SOIC8
CASE 751EB
ISSUE A

DATE 24 AUG 2017



\varnothing 0.25 (M) C B A

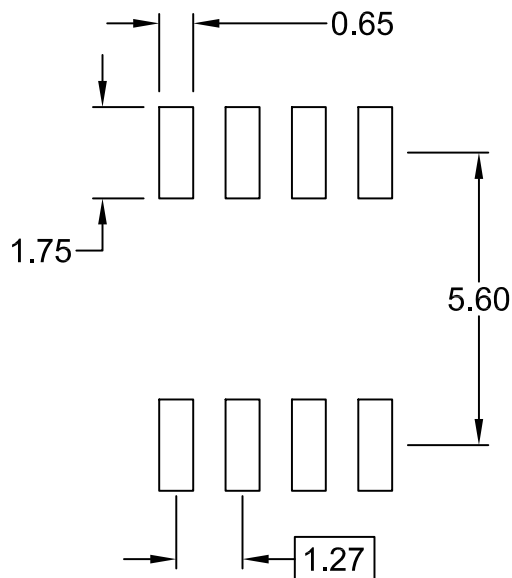

LAND PATTERN RECOMMENDATION

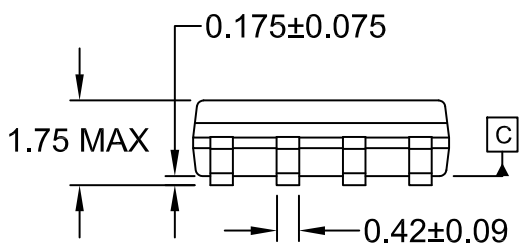

$\frac{1}{2}$ 0.10

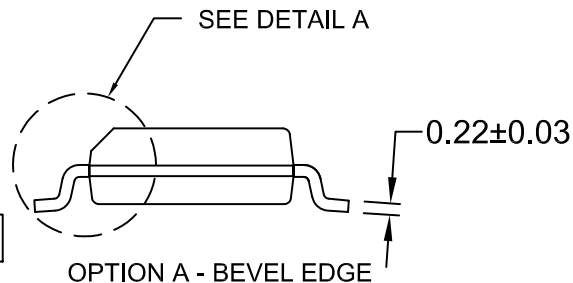

OPTION B - NO BEVEL EDGE

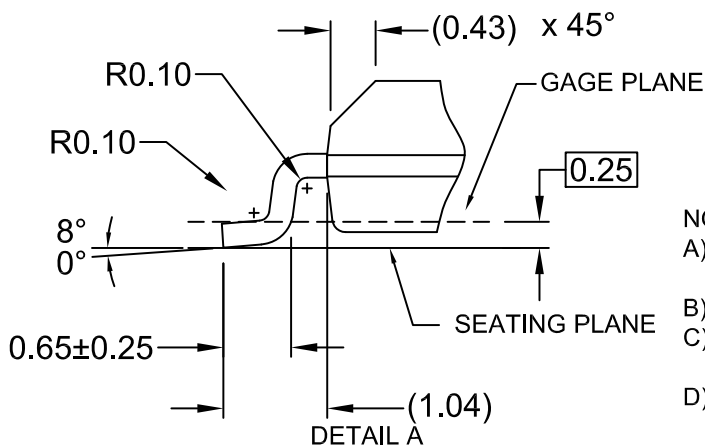

SCALE: 2:1

NOTES:

- A) THIS PACKAGE CONFORMS TO JEDEC MS-012, VARIATION AA.
- B) ALL DIMENSIONS ARE IN MILLIMETERS.
- C) DIMENSIONS DO NOT INCLUDE MOLD FLASH OR BURRS.
- D) LANDPATTERN STANDARD: SOIC127P600X175-8M

DOCUMENT NUMBER:	98AON13735G	Electronic versions are uncontrolled except when accessed directly from the Document Repository. Printed versions are uncontrolled except when stamped "CONTROLLED COPY" in red.
DESCRIPTION:	SOIC8	PAGE 1 OF 1

ON Semiconductor and are trademarks of Semiconductor Components Industries, LLC dba ON Semiconductor or its subsidiaries in the United States and/or other countries. ON Semiconductor reserves the right to make changes without further notice to any products herein. ON Semiconductor makes no warranty, representation or guarantee regarding the suitability of its products for any particular purpose, nor does ON Semiconductor assume any liability arising out of the application or use of any product or circuit, and specifically disclaims any and all liability, including without limitation special, consequential or incidental damages. ON Semiconductor does not convey any license under its patent rights nor the rights of others.

onsemi, **Onsemi**, and other names, marks, and brands are registered and/or common law trademarks of Semiconductor Components Industries, LLC dba "**onsemi**" or its affiliates and/or subsidiaries in the United States and/or other countries. **onsemi** owns the rights to a number of patents, trademarks, copyrights, trade secrets, and other intellectual property. A listing of **onsemi**'s product/patent coverage may be accessed at www.onsemi.com/site/pdf/Patent-Marking.pdf. **onsemi** reserves the right to make changes at any time to any products or information herein, without notice. The information herein is provided "as-is" and **onsemi** makes no warranty, representation or guarantee regarding the accuracy of the information, product features, availability, functionality, or suitability of its products for any particular purpose, nor does **onsemi** assume any liability arising out of the application or use of any product or circuit, and specifically disclaims any and all liability, including without limitation special, consequential or incidental damages. Buyer is responsible for its products and applications using **onsemi** products, including compliance with all laws, regulations and safety requirements or standards, regardless of any support or applications information provided by **onsemi**. "Typical" parameters which may be provided in **onsemi** data sheets and/or specifications can and do vary in different applications and actual performance may vary over time. All operating parameters, including "Typicals" must be validated for each customer application by customer's technical experts. **onsemi** does not convey any license under any of its intellectual property rights nor the rights of others. **onsemi** products are not designed, intended, or authorized for use as a critical component in life support systems or any FDA Class 3 medical devices or medical devices with a same or similar classification in a foreign jurisdiction or any devices intended for implantation in the human body. Should Buyer purchase or use **onsemi** products for any such unintended or unauthorized application, Buyer shall indemnify and hold **onsemi** and its officers, employees, subsidiaries, affiliates, and distributors harmless against all claims, costs, damages, and expenses, and reasonable attorney fees arising out of, directly or indirectly, any claim of personal injury or death associated with such unintended or unauthorized use, even if such claim alleges that **onsemi** was negligent regarding the design or manufacture of the part. **onsemi** is an Equal Opportunity/Affirmative Action Employer. This literature is subject to all applicable copyright laws and is not for resale in any manner.

ADDITIONAL INFORMATION

TECHNICAL PUBLICATIONS:

Technical Library: www.onsemi.com/design/resources/technical-documentation
onsemi Website: www.onsemi.com

ONLINE SUPPORT: www.onsemi.com/support

For additional information, please contact your local Sales Representative at www.onsemi.com/support/sales