

Complementary Power Transistors

DPAK For Surface Mount Applications

MJD31 (NPN), MJD32 (PNP)

Designed for general purpose amplifier and low speed switching applications.

Features

- Lead Formed for Surface Mount Applications in Plastic Sleeves
- Straight Lead Version in Plastic Sleeves (“1” Suffix)
- Lead Formed Version in 16 mm Tape and Reel (“T4” Suffix)
- Electrically Similar to Popular TIP31 and TIP32 Series
- Epoxy Meets UL 94, V-0 @ 0.125 in
- NJV Prefix for Automotive and Other Applications Requiring Unique Site and Control Change Requirements; AEC-Q101 Qualified and PPAP Capable
- These Devices are Pb-Free and are RoHS Compliant

MAXIMUM RATINGS

Rating	Symbol	Max	Unit
Collector-Emitter Voltage MJD31, MJD32 MJD31C, MJD32C	V_{CEO}	40 100	Vdc
Collector-Base Voltage MJD31, MJD32 MJD31C, MJD32C	V_{CB}	40 100	Vdc
Emitter-Base Voltage	V_{EB}	5.0	Vdc
Collector Current - Continuous	I_C	3.0	Adc
Collector Current - Peak	I_{CM}	5.0	Adc
Base Current	I_B	1.0	Adc
Total Power Dissipation @ $T_C = 25^\circ\text{C}$ Derate above 25°C	P_D	15 0.12	W W/ $^\circ\text{C}$
Total Power Dissipation @ $T_A = 25^\circ\text{C}$ Derate above 25°C	P_D	1.56 0.012	W W/ $^\circ\text{C}$
Operating and Storage Junction Temperature Range	T_J, T_{stg}	-65 to +150	$^\circ\text{C}$
ESD - Human Body Model	HBM	3B	V
ESD - Machine Model	MM	M3	V

Stresses exceeding those listed in the Maximum Ratings table may damage the device. If any of these limits are exceeded, device functionality should not be assumed, damage may occur and reliability may be affected.

THERMAL CHARACTERISTICS

Characteristic	Symbol	Max	Unit
Thermal Resistance, Junction-to-Case	$R_{\theta JC}$	8.3	$^\circ\text{C}/\text{W}$
Thermal Resistance, Junction-to-Ambient*	$R_{\theta JA}$	80	$^\circ\text{C}/\text{W}$
Lead Temperature for Soldering Purposes	T_L	260	$^\circ\text{C}$

*These ratings are applicable when surface mounted on the minimum pad sizes recommended.

SILICON POWER TRANSISTORS 3 AMPERES 40 AND 100 VOLTS 15 WATTS

COMPLEMENTARY

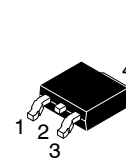
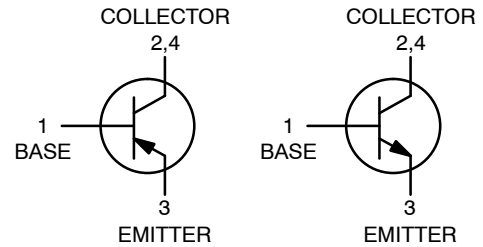

DPAK
CASE 369C
STYLE 1

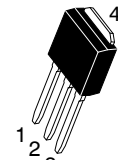

IPAQ
CASE 369D
STYLE 1

MARKING DIAGRAMS

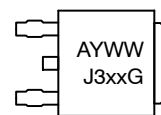

DPAK

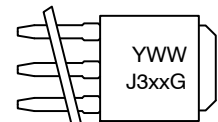

IPAQ

- A = Site Code
- Y = Year
- WW = Work Week
- xx = 1, 1C, 2, or 2C
- G = Pb-Free Package

ORDERING INFORMATION

See detailed ordering and shipping information in the package dimensions section on page 8 of this data sheet.

MJD31 (NPN), MJD32 (PNP)

ELECTRICAL CHARACTERISTICS ($T_C = 25^\circ\text{C}$ unless otherwise noted)

Characteristic	Symbol	Min	Max	Unit
----------------	--------	-----	-----	------

OFF CHARACTERISTICS

Collector-Emitter Sustaining Voltage (Note 1) ($I_C = 30\text{ mA}$, $I_B = 0$) MJD31, MJD32 MJD31C, MJD32C	$V_{CEO(sus)}$	40 100	– –	Vdc
Collector Cutoff Current ($V_{CE} = 40\text{ Vdc}$, $I_B = 0$) MJD31, MJD32 ($V_{CE} = 60\text{ Vdc}$, $I_B = 0$) MJD31C, MJD32C	I_{CEO}	– –	50 50	μA
Collector Cutoff Current ($V_{CE} = \text{Rated } V_{CEO}$, $V_{EB} = 0$)	ICES	–	20	μA
Emitter Cutoff Current ($V_{BE} = 5\text{ Vdc}$, $I_C = 0$)	I_{EBO}	–	1	mA

ON CHARACTERISTICS (Note 1)

DC Current Gain ($I_C = 1\text{ A}$, $V_{CE} = 4\text{ Vdc}$) ($I_C = 3\text{ A}$, $V_{CE} = 4\text{ Vdc}$)	h_{FE}	25 10	– 50	
Collector-Emitter Saturation Voltage ($I_C = 3\text{ A}$, $I_B = 375\text{ mA}$)	$V_{CE(sat)}$	–	1.2	Vdc
Base-Emitter On Voltage ($I_C = 3\text{ A}$, $V_{CE} = 4\text{ Vdc}$)	$V_{BE(on)}$	–	1.8	Vdc

DYNAMIC CHARACTERISTICS

Current Gain – Bandwidth Product (Note 2) ($I_C = 500\text{ mA}$, $V_{CE} = 10\text{ Vdc}$, $f_{test} = 1\text{ MHz}$)	f_T	3	–	MHz
Small-Signal Current Gain ($I_C = 0.5\text{ A}$, $V_{CE} = 10\text{ Vdc}$, $f = 1\text{ kHz}$)	h_{fe}	20	–	

Product parametric performance is indicated in the Electrical Characteristics for the listed test conditions, unless otherwise noted. Product performance may not be indicated by the Electrical Characteristics if operated under different conditions.

1. Pulse Test: Pulse Width $\leq 300\ \mu\text{s}$, Duty Cycle $\leq 2\%$.
2. $f_T = |h_{fe}| \cdot f_{test}$.

MJD31 (NPN), MJD32 (PNP)

TYPICAL CHARACTERISTICS



Figure 1. Power Derating



R_B and R_C VARIED TO OBTAIN DESIRED CURRENT LEVELS
 D_1 MUST BE FAST RECOVERY TYPE, e.g.:
 1N5825 USED ABOVE $I_B \approx 100$ mA
 MSD6100 USED BELOW $I_B \approx 100$ mA
 REVERSE ALL POLARITIES FOR PNP.

Figure 2. Switching Time Test Circuit



Figure 3. Turn-On Time



Figure 4. Turn-Off Time



Figure 5. Thermal Response

MJD31 (NPN), MJD32 (PNP)

TYPICAL CHARACTERISTICS – MJD31, MJD31C (NPN)

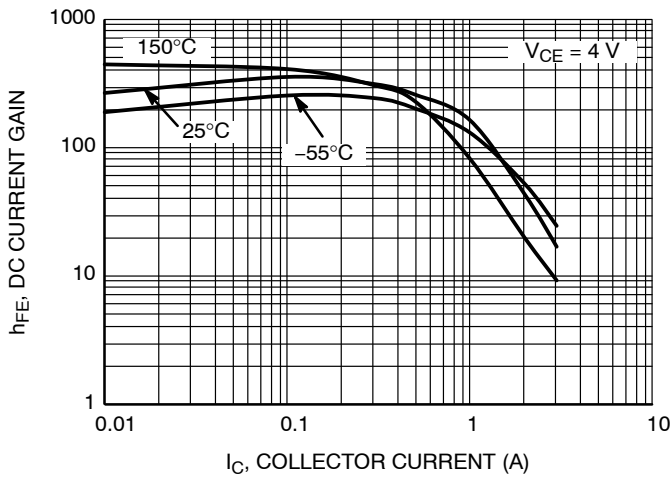

Figure 6. DC Current Gain at $V_{CE} = 4\text{ V}$

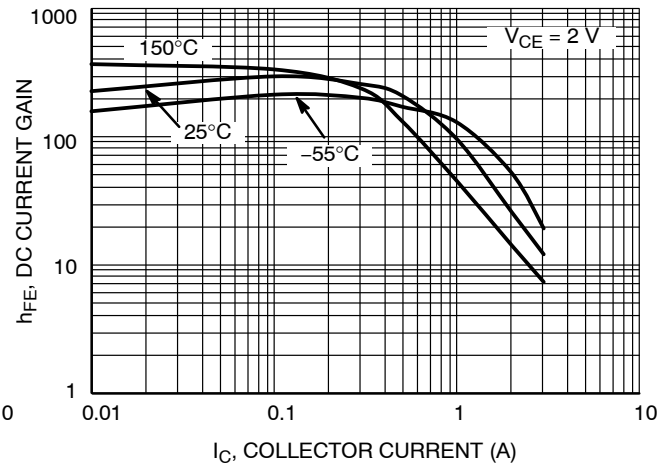

Figure 7. DC Current Gain at $V_{CE} = 2\text{ V}$



Figure 8. Collector-Emitt Saturation Voltage

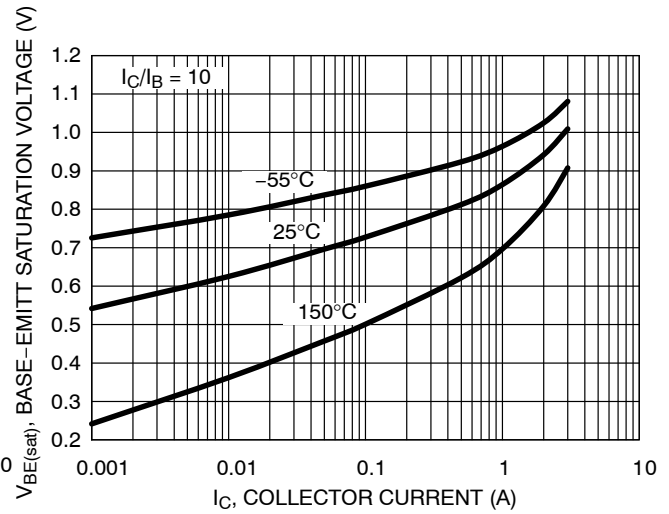

Figure 9. Base-Emitt Saturation Voltage



Figure 10. Base-Emitt "On" Voltage

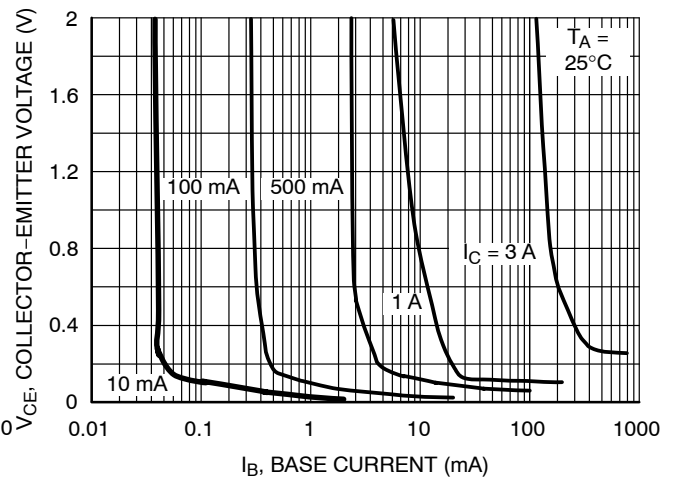

Figure 11. Collector Saturation Region

MJD31 (NPN), MJD32 (PNP)

TYPICAL CHARACTERISTICS – MJD31, MJD31C (NPN)

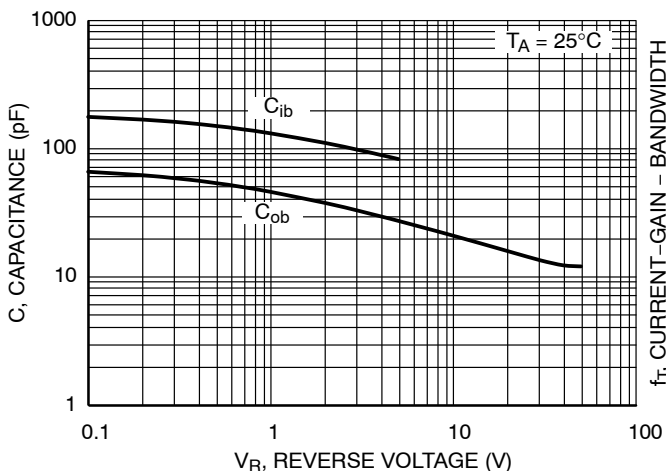

Figure 12. Capacitance

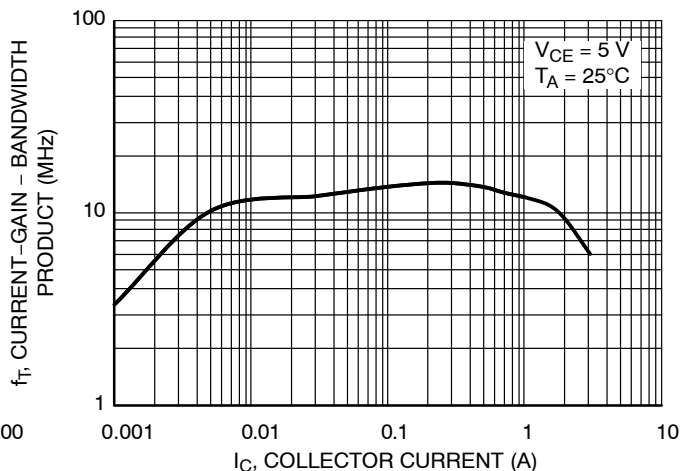

Figure 13. Current-Gain-Bandwidth Product

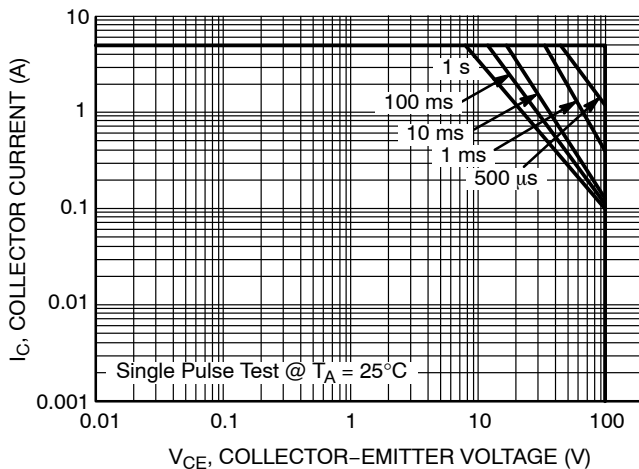

Figure 14. Safe Operating Area

MJD31 (NPN), MJD32 (PNP)

TYPICAL CHARACTERISTICS – MJD32, MJD32C (PNP)



Figure 15. DC Current Gain at $V_{CE} = 4\text{ V}$

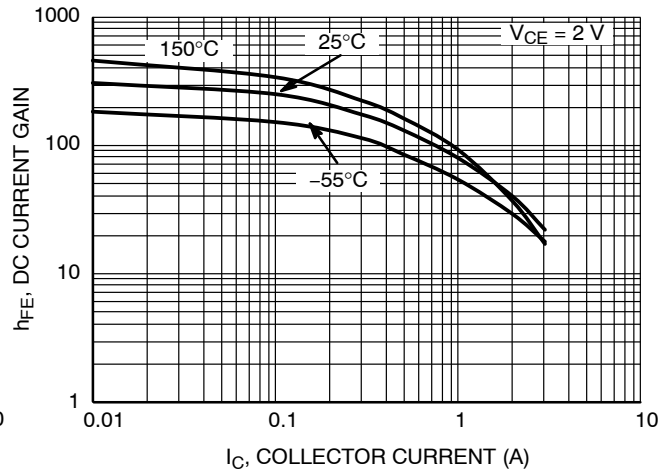

Figure 16. DC Current Gain at $V_{CE} = 2\text{ V}$

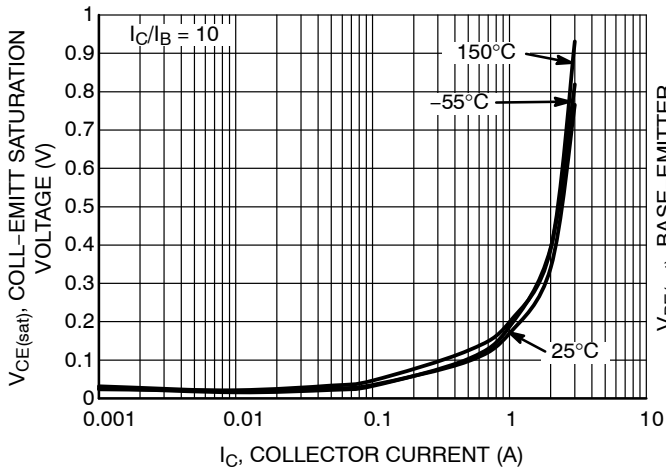

Figure 17. Collector-Emitter Saturation Voltage

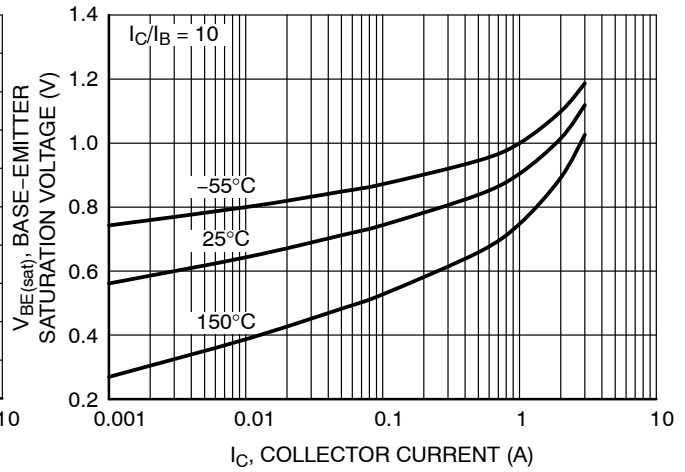

Figure 18. Base-Emitter Saturation Voltage

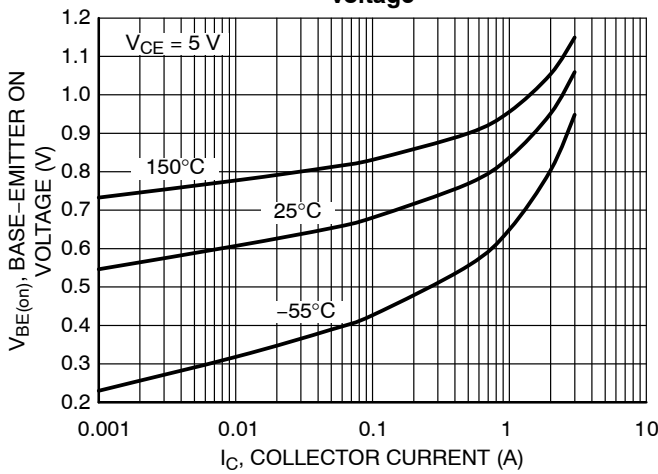

Figure 19. Base-Emitter "On" Voltage

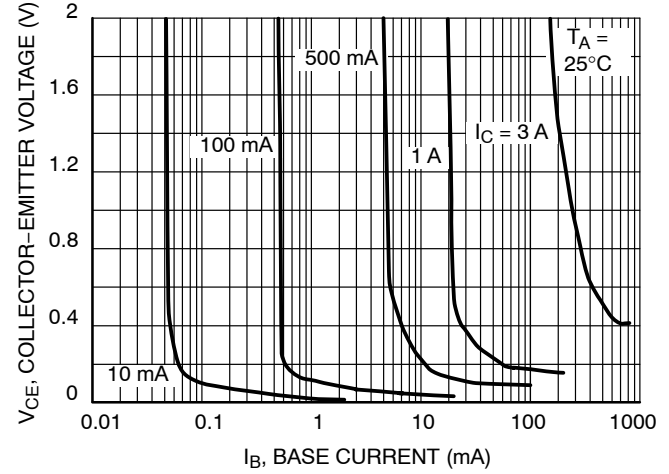

Figure 20. Collector Saturation Region

MJD31 (NPN), MJD32 (PNP)

TYPICAL CHARACTERISTICS

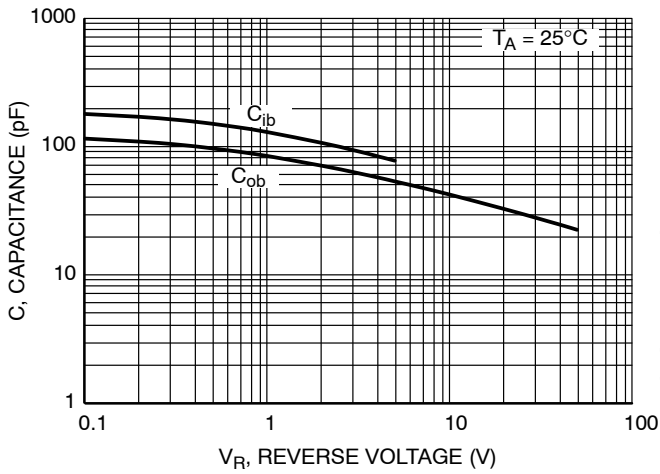

Figure 21. Capacitance

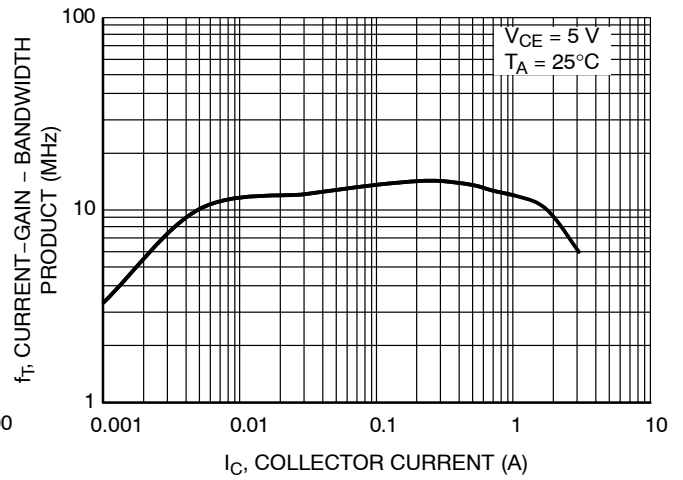

Figure 22. Current-Gain-Bandwidth Product

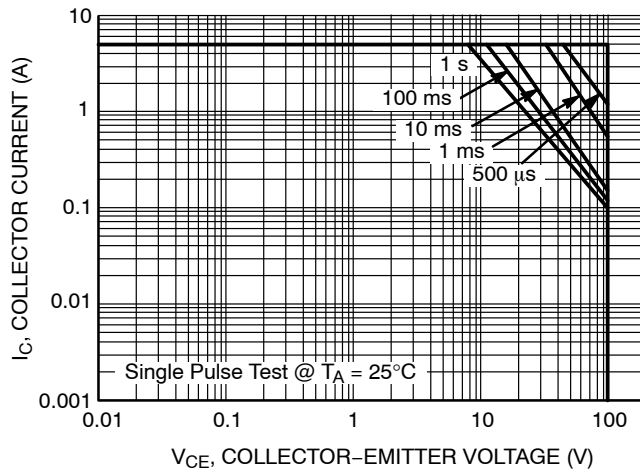

Figure 23. Safe Operating Area

MJD31 (NPN), MJD32 (PNP)

ORDERING INFORMATION

Device	Package Type	Package	Shipping [†]
MJD31CG	DPAK (Pb-Free)	369C	75 Units / Rail
NJVMJD31CG*	DPAK (Pb-Free)	369C	75 Units / Rail
MJD31C1G	IPAK (Pb-Free)	369D	75 Units / Rail
MJD31CRLG	DPAK (Pb-Free)	369C	1,800 / Tape & Reel
NJVMJD31CRLG*	DPAK (Pb-Free)	369C	1,800 / Tape & Reel
MJD31CT4G	DPAK (Pb-Free)	369C	2,500 / Tape & Reel
NJVMJD31CT4G*	DPAK (Pb-Free)	369C	2,500 / Tape & Reel
MJD31T4G	DPAK (Pb-Free)	369C	2,500 / Tape & Reel
MJD31T4GN	DPAK (Pb-Free)	369C	2,500 / Tape & Reel
NJVMJD31T4G*	DPAK (Pb-Free)	369C	2,500 / Tape & Reel
MJD32CG	DPAK (Pb-Free)	369C	75 Units / Rail
NJVMJD32CG*	DPAK (Pb-Free)	369C	75 Units / Rail
MJD32CRLG	DPAK (Pb-Free)	369C	1,800 / Tape & Reel
MJD32CT4G	DPAK (Pb-Free)	369C	2,500 / Tape & Reel
MJD32CT4GN	DPAK (Pb-Free)	369C	2,500 / Tape & Reel
NJVMJD32CT4G*	DPAK (Pb-Free)	369C	2,500 / Tape & Reel
MJD32RLG	DPAK (Pb-Free)	369C	1,800 / Tape & Reel
MJD32T4G	DPAK (Pb-Free)	369C	2,500 / Tape & Reel
NJVMJD32T4G*	DPAK (Pb-Free)	369C	2,500 / Tape & Reel

[†]For information on tape and reel specifications, including part orientation and tape sizes, please refer to our Tape and Reel Packaging Specifications Brochure, BRD8011/D.

*NJV Prefix for Automotive and Other Applications Requiring Unique Site and Control Change Requirements; AEC-Q101 Qualified and PPAP Capable.

MECHANICAL CASE OUTLINE

PACKAGE DIMENSIONS

ON Semiconductor®



IPAK CASE 369D-01 ISSUE C

DATE 15 DEC 2010

SCALE 1:1



NOTES:

1. DIMENSIONING AND TOLERANCING PER ANSI Y14.5M, 1982.
2. CONTROLLING DIMENSION: INCH.

DIM	INCHES		MILLIMETERS	
	MIN	MAX	MIN	MAX
A	0.235	0.245	5.97	6.35
B	0.250	0.265	6.35	6.73
C	0.086	0.094	2.19	2.38
D	0.027	0.035	0.69	0.88
E	0.018	0.023	0.46	0.58
F	0.037	0.045	0.94	1.14
G	0.090	BSC	2.29	BSC
H	0.034	0.040	0.87	1.01
J	0.018	0.023	0.46	0.58
K	0.350	0.380	8.89	9.65
R	0.180	0.215	4.45	5.45
S	0.025	0.040	0.63	1.01
V	0.035	0.050	0.89	1.27
Z	0.155	---	3.93	---

MARKING DIAGRAMS

- | | | | |
|--|---|--|--|
| <p>STYLE 1:
PIN 1. BASE
2. COLLECTOR
3. EMITTER
4. COLLECTOR</p> | <p>STYLE 2:
PIN 1. GATE
2. DRAIN
3. SOURCE
4. DRAIN</p> | <p>STYLE 3:
PIN 1. ANODE
2. CATHODE
3. ANODE
4. CATHODE</p> | <p>STYLE 4:
PIN 1. CATHODE
2. ANODE
3. GATE
4. ANODE</p> |
| <p>STYLE 5:
PIN 1. GATE
2. ANODE
3. CATHODE
4. ANODE</p> | <p>STYLE 6:
PIN 1. MT1
2. MT2
3. GATE
4. MT2</p> | <p>STYLE 7:
PIN 1. GATE
2. COLLECTOR
3. EMITTER
4. COLLECTOR</p> | |

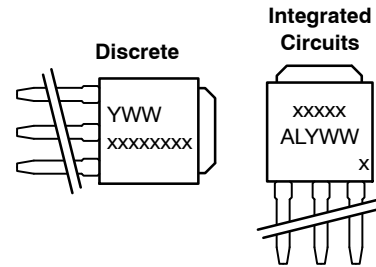

- xxxxxxx = Device Code
A = Assembly Location
IL = Wafer Lot
Y = Year
WW = Work Week

DOCUMENT NUMBER:	98AON10528D	Electronic versions are uncontrolled except when accessed directly from the Document Repository. Printed versions are uncontrolled except when stamped "CONTROLLED COPY" in red.
DESCRIPTION:	IPAK (DPAK INSERTION MOUNT)	PAGE 1 OF 1

ON Semiconductor and are trademarks of Semiconductor Components Industries, LLC dba ON Semiconductor or its subsidiaries in the United States and/or other countries. ON Semiconductor reserves the right to make changes without further notice to any products herein. ON Semiconductor makes no warranty, representation or guarantee regarding the suitability of its products for any particular purpose, nor does ON Semiconductor assume any liability arising out of the application or use of any product or circuit, and specifically disclaims any and all liability, including without limitation special, consequential or incidental damages. ON Semiconductor does not convey any license under its patent rights nor the rights of others.

MECHANICAL CASE OUTLINE PACKAGE DIMENSIONS



DPAK (SINGLE GAUGE) CASE 369C ISSUE G

DATE 31 MAY 2023

SCALE 1:1

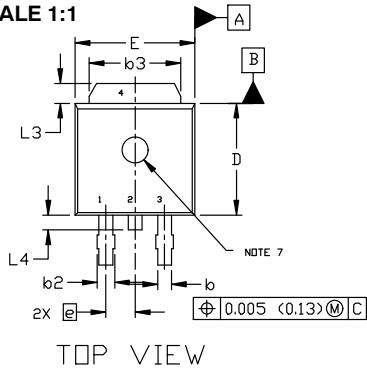

TOP VIEW

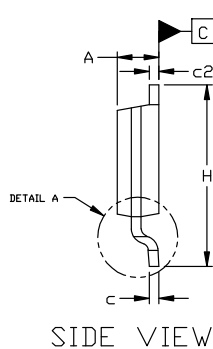

SIDE VIEW

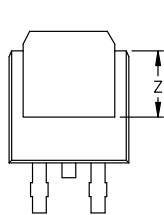

BOTTOM VIEW

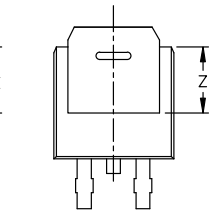
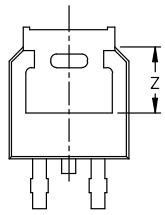

BOTTOM VIEW

ALTERNATE CONSTRUCTIONS

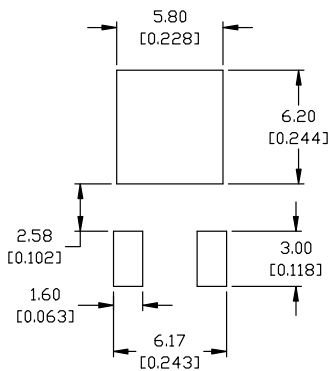

RECOMMENDED MOUNTING FOOTPRINT*

*FOR ADDITIONAL INFORMATION ON OUR Pb-FREE STRATEGY AND SOLDERING DETAILS, PLEASE DOWNLOAD THE ON SEMICONDUCTOR SOLDERING AND MOUNTING TECHNIQUES REFERENCE MANUAL, SOLDERRM/D.

- | | | | | |
|--|--|---|---|--|
| <p>STYLE 1:
PIN 1. BASE
2. COLLECTOR
3. EMITTER
4. COLLECTOR</p> | <p>STYLE 2:
PIN 1. GATE
2. DRAIN
3. SOURCE
4. DRAIN</p> | <p>STYLE 3:
PIN 1. ANODE
2. CATHODE
3. ANODE
4. CATHODE</p> | <p>STYLE 4:
PIN 1. CATHODE
2. ANODE
3. GATE
4. ANODE</p> | <p>STYLE 5:
PIN 1. GATE
2. ANODE
3. CATHODE
4. ANODE</p> |
| <p>STYLE 6:
PIN 1. MT1
2. MT2
3. GATE
4. MT2</p> | <p>STYLE 7:
PIN 1. GATE
2. COLLECTOR
3. EMITTER
4. COLLECTOR</p> | <p>STYLE 8:
PIN 1. N/C
2. CATHODE
3. ANODE
4. CATHODE</p> | <p>STYLE 9:
PIN 1. ANODE
2. CATHODE
3. RESISTOR ADJUST
4. CATHODE</p> | <p>STYLE 10:
PIN 1. CATHODE
2. ANODE
3. CATHODE
4. ANODE</p> |

NOTES:

- DIMENSIONING AND TOLERANCING ASME Y14.5M, 1994.
- CONTROLLING DIMENSION: INCHES
- THERMAL PAD CONTOUR OPTIONAL WITHIN DIMENSIONS b3, L3, AND Z.
- DIMENSIONS D AND E DO NOT INCLUDE MOLD FLASH, PROTRUSIONS, OR BURRS. MOLD FLASH, PROTRUSIONS, OR GATE BURRS SHALL NOT EXCEED 0.006 INCHES PER SIDE.
- DIMENSIONS D AND E ARE DETERMINED AT THE OUTERMOST EXTREMES OF THE PLASTIC BODY.
- DATUMS A AND B ARE DETERMINED AT DATUM PLANE H.
- OPTIONAL MOLD FEATURE.

DIM	INCHES		MILLIMETERS	
	MIN.	MAX.	MIN.	MAX.
A	0.086	0.094	2.18	2.38
A1	0.000	0.005	0.00	0.13
b	0.025	0.035	0.63	0.89
b2	0.028	0.045	0.72	1.14
b3	0.180	0.215	4.57	5.46
c	0.018	0.024	0.46	0.61
c2	0.018	0.024	0.46	0.61
D	0.235	0.245	5.97	6.22
E	0.250	0.265	6.35	6.73
e	0.090	BSC	2.29	BSC
H	0.370	0.410	9.40	10.41
L	0.055	0.070	1.40	1.78
L1	0.114	REF	2.90	REF
L2	0.020	BSC	0.51	BSC
L3	0.035	0.050	0.89	1.27
L4	----	0.040	---	1.01
Z	0.155	----	3.93	---

GENERIC MARKING DIAGRAM*

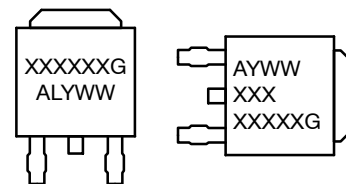

IC

Discrete

- XXXXXX = Device Code
- A = Assembly Location
- L = Wafer Lot
- Y = Year
- WW = Work Week
- G = Pb-Free Package

*This information is generic. Please refer to device data sheet for actual part marking. Pb-Free indicator, "G" or microdot "•", may or may not be present. Some products may not follow the Generic Marking.

DOCUMENT NUMBER:	98AON10527D	Electronic versions are uncontrolled except when accessed directly from the Document Repository. Printed versions are uncontrolled except when stamped "CONTROLLED COPY" in red.
DESCRIPTION:	DPAK (SINGLE GAUGE)	PAGE 1 OF 1

onsemi and onsemi are trademarks of Semiconductor Components Industries, LLC dba onsemi or its subsidiaries in the United States and/or other countries. onsemi reserves the right to make changes without further notice to any products herein. onsemi makes no warranty, representation or guarantee regarding the suitability of its products for any particular purpose, nor does onsemi assume any liability arising out of the application or use of any product or circuit, and specifically disclaims any and all liability, including without limitation special, consequential or incidental damages. onsemi does not convey any license under its patent rights nor the rights of others.

onsemi, **Onsemi**, and other names, marks, and brands are registered and/or common law trademarks of Semiconductor Components Industries, LLC dba "**onsemi**" or its affiliates and/or subsidiaries in the United States and/or other countries. **onsemi** owns the rights to a number of patents, trademarks, copyrights, trade secrets, and other intellectual property. A listing of **onsemi**'s product/patent coverage may be accessed at www.onsemi.com/site/pdf/Patent-Marking.pdf. **onsemi** reserves the right to make changes at any time to any products or information herein, without notice. The information herein is provided "as-is" and **onsemi** makes no warranty, representation or guarantee regarding the accuracy of the information, product features, availability, functionality, or suitability of its products for any particular purpose, nor does **onsemi** assume any liability arising out of the application or use of any product or circuit, and specifically disclaims any and all liability, including without limitation special, consequential or incidental damages. Buyer is responsible for its products and applications using **onsemi** products, including compliance with all laws, regulations and safety requirements or standards, regardless of any support or applications information provided by **onsemi**. "Typical" parameters which may be provided in **onsemi** data sheets and/or specifications can and do vary in different applications and actual performance may vary over time. All operating parameters, including "Typicals" must be validated for each customer application by customer's technical experts. **onsemi** does not convey any license under any of its intellectual property rights nor the rights of others. **onsemi** products are not designed, intended, or authorized for use as a critical component in life support systems or any FDA Class 3 medical devices or medical devices with a same or similar classification in a foreign jurisdiction or any devices intended for implantation in the human body. Should Buyer purchase or use **onsemi** products for any such unintended or unauthorized application, Buyer shall indemnify and hold **onsemi** and its officers, employees, subsidiaries, affiliates, and distributors harmless against all claims, costs, damages, and expenses, and reasonable attorney fees arising out of, directly or indirectly, any claim of personal injury or death associated with such unintended or unauthorized use, even if such claim alleges that **onsemi** was negligent regarding the design or manufacture of the part. **onsemi** is an Equal Opportunity/Affirmative Action Employer. This literature is subject to all applicable copyright laws and is not for resale in any manner.

ADDITIONAL INFORMATION

TECHNICAL PUBLICATIONS:

Technical Library: www.onsemi.com/design/resources/technical-documentation
onsemi Website: www.onsemi.com

ONLINE SUPPORT: www.onsemi.com/support

For additional information, please contact your local Sales Representative at www.onsemi.com/support/sales

