



FEATURES

- For surface mounted applications
- Fast reverse recovery time
- Ideal for automated placement
- Lead free in comply with EU RoHS 2011/65/EU directives

MECHANICAL DATA

- Case: SOD-123W
- Terminals: Solderable per MIL-STD-750, Method 2026
- Approx. Weight: 16mg/0. 00056oz

PINNING

PIN	DESCRIPTION
1	Cathode
2	Anode

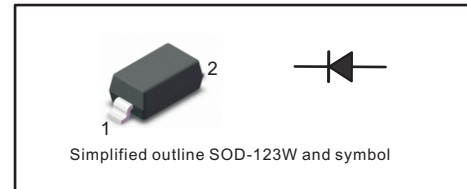

Absolute Maximum Ratings at 25 °C

Parameter	Symbols	BAV19WA	BAV20WA	BAV21WA	Units
Non-Repetitive Peak Reverse Voltage	V_{RM}	120	200	250	V
RMS Reverse Voltage	V_{RMS}	71	106	141	V
Average Rectified Output Current	I_O	200			mA
Repetitive Peak Forward Current	I_{FRM}	625			mA
Non-repetitive Peak Forward Surge Current @t < 8. 3mS	I_{FSM}	2			A
Total Power Dissipation	P_{tot}	500			mW
Operating and Storage Temperature Range	T_j, T_{stg}	-55 ~ +150			°C

Characteristics at $T_a = 25\text{ °C}$

Parameter	Symbols	BAV19WA	BAV20WA	BAV21WA	Units
Reverse Breakdown Voltage at $I_R = 100\mu A$	$V_{(BR)R}$	120	200	250	V
Maximum Forward Voltage at 100 mA at 200 mA	V_F	1.00 1.25			V
Maximum DC Reverse Current at Rated DC Blocking Voltage $T_a = 25\text{ °C}$	I_R	0.1			μA
Typical Junction Capacitance at $V_R = 0V, f = 1MHz$	C_j	5			pF
Maximum Reverse Recovery Time ⁽¹⁾	t_{rr}	50			ns

(1) Measured with $I_F = 0.5 A, I_R = 1 A, I_{rr} = 0.25 A$



Fig.1 Power Derating Curve

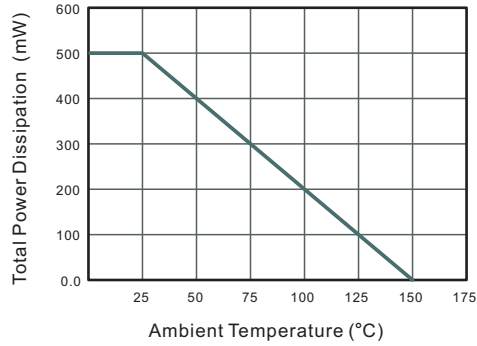

Fig.2 Typical Reverse Characteristics

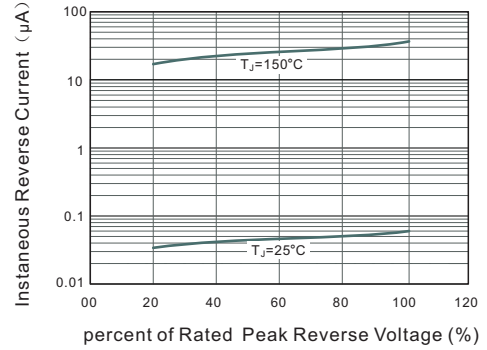

Fig.3 Typical Instantaneous Forward Characteristics

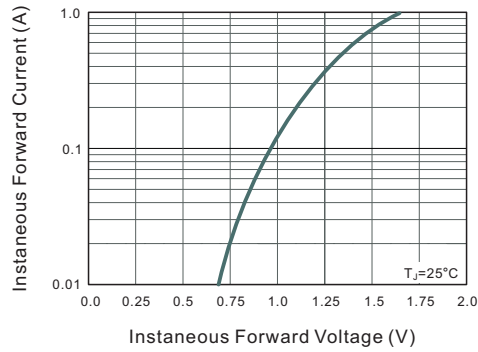
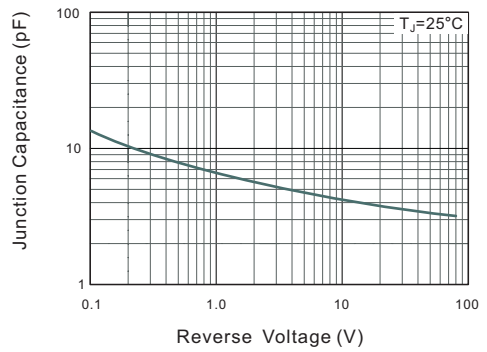

Fig.4 Typical Junction Capacitance





PACKAGE OUTLINE

Plastic surface mounted package; 2 leads

SOD-123W

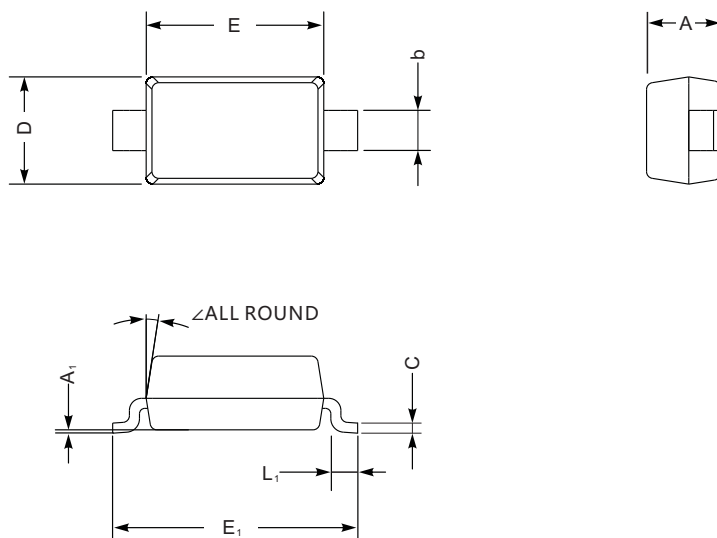

SOD-123W mechanical data

UNIT		A	C	D	E	E ₁	L ₁	b	A ₁	∠
mm	max	1.3	0.22	1.8	2.8	3.9	0.45	0.7	0.2	9°
	min	0.9	0.09	1.5	2.5	3.6	0.25	0.5	—	
mil	max	51	8.7	71	110	154	18	28	8	
	min	35	3.5	59	98	142	10	20	—	

The recommended mounting pad size

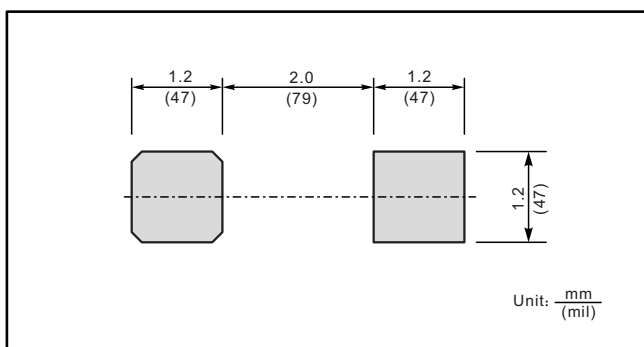

Marking

Type number	Marking code
BAV19WA	A8
BAV20WA	T2
BAV21WA	T3