

# K12S

## High Performance SMT Key Switches



### Features/Benefits

- Harsh environment applications - IP67
- Compatible with SMT lead free soldering process
- Illuminated
- Excellent tactile feel
- High reliability / long life
- DPST and detect versions available
- RoHS compliant

### Typical Applications

- Automotive
- Joysticks
- Off-road transportation
- Motorcycles
- Industrial
- Medical

### Construction:

FUNCTION: Momentary  
 CONTACT ARRANGEMENT: SPST or DPST  
 CONTACT TYPE: NO or NC  
 TERMINALS: SMT

### Mechanical

TOTAL TRAVEL: 1,5 mm  
 OPERATING FORCE: 3N; 3,5N; 5N; 6N; 9N 4/8 N; 6/12 N  
 SEALING: IP40 or IP67

### Packaging

Reels of 900 pieces

### Electrical

SWITCHING POWER MIN./MAX.: 0.02mW/3 W DC  
 SWITCHING VOLTAGE MIN./MAX.: 2 V / 30 V DC  
 SWITCHING CURRENT MIN./MAX.: 10 mA /100 mA DC  
 DIELECTRIC STRENGTH: > 300 V RMS  
 OPERATING LIFE: > 10<sup>6</sup> operations (detect version) / 2x10<sup>5</sup> operations (versions with tactile effect)  
 CONTACT RESISTANCE: Initial < 100mΩ - After test < 250mΩ  
 INSULATION RESISTANCE: >10<sup>9</sup> Ω  
 BOUNCE TIME: < 10 ms

### Environmental

OPERATING TEMPERATURE: -40°C to 85°C.  
 STORAGE TEMPERATURE: -40°C to 95°C.  
 RoHS compliant and Halogen free.

### Process

SOLDERABILITY: Lead free soldering compatible.

### How To Order

Our easy build-a-switch concept allows you to mix and match options to create the switch you need. To order, select desired option from each category and place it in the appropriate box.



#### Sub-Series

- A** IP40 with peg
- B** IP67 with peg
- C** IP40 without peg
- D** IP67 without peg

#### Option

- S** SPST version
- L** LED version (SPST)
- D** DPST version

#### LED Color

- NONE** No LED
- YE0** Yellow
- RD0** Red
- GN0** Green
- OR0** Orange
- WHO** White
- AMO** Amber

**Travel**  
**1.5** 1.5 mm

#### Operating Force

- 3N** 3 N (detect - no tactile)
- 3.5N** 3,5 N
- 5N** 5 N
- 6N** 6 N
- 9N** 9 N
- 4/8N** 4/8 N DPST (double step actuation)
- 6/12N** 6/12 N DPST (double step actuation)

#### Contact Arrangement

- O** Normally open (SPST)
- C** Normally closed (SPST)
- OO** 2 Normally open (DPST)
- CC\*** 2 Normally closed (DPST)
- OC\*** 1 Normally open
- 1 Normally closed (DPST)

**LFTX** Lead free, RoHS terminals tin plated Translucent button

\* Please contact technical support for this configuration

# K12S High Performance SMT Key Switches

**K12SA/K12SC** IP40 with peg / IP40 without peg

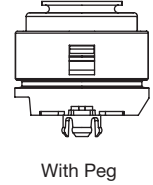
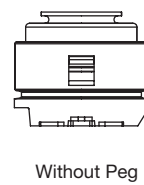
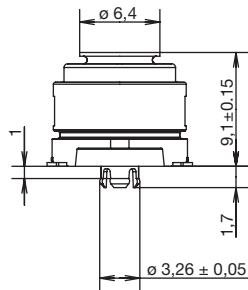
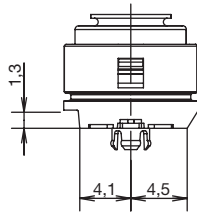
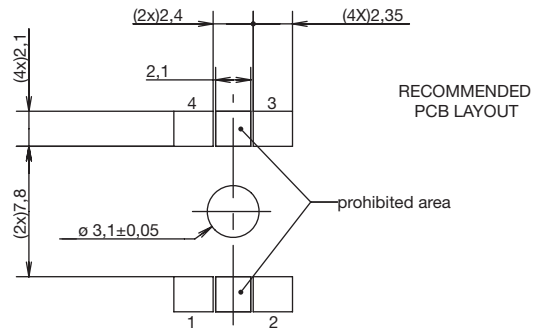
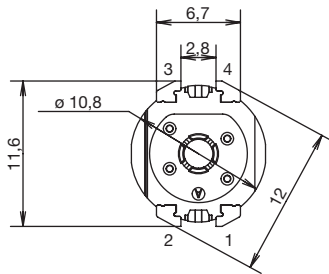

**K12SB / K12SD** IP67 with peg / IP67 without peg

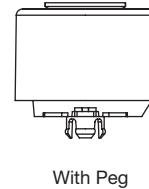
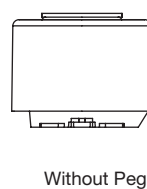
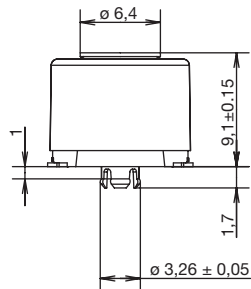
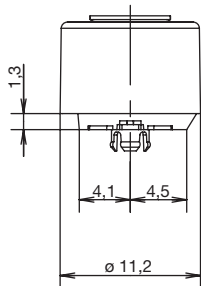
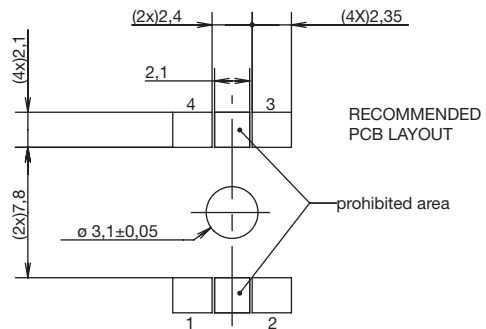
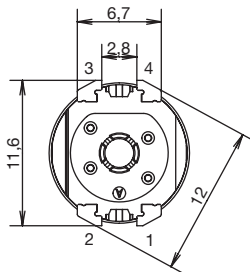

D

Key Switches



First Angle Projection

Dimensions are shown: mm  
Specifications and dimensions subject to change

# K12S High Performance SMT Key Switches

## OPTION

**S** SPST version

**L** LED version

**D** DPST version

Single NO

Single NC

Single NO  
+ LED

Single NC  
+ LED

Double NO

Double NC

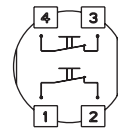
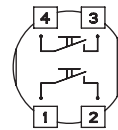
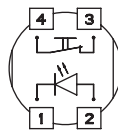
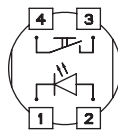
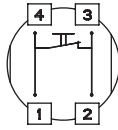
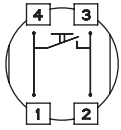

## LED COLOR

OPTION CODE	LED COLOR
	No LED
<b>YE0</b>	Yellow
<b>RD0</b>	Red
<b>GN0</b>	Green
<b>OR0</b>	Orange
<b>WH0</b>	White
<b>AM0</b>	Amber

## TRAVEL

**1.5** 1.5 mm

## OPERATING FORCE

OPTION CODE	OPERATING FORCE
<b>3N</b>	3N (detect - no tactile)
<b>3.5N</b>	3.5N
<b>5N</b>	5N
<b>6N</b>	6N
<b>9N</b>	9N
<b>4/8N</b>	4/8N (double step actuation)
<b>6/12N</b>	6/12N (double step actuation)

## CONTACT ARRANGEMENT

- O** Normally open (SPST and LED versions)
- C** Normally closed (SPST and LED versions)
- OO** 2 Normally open (DPST version)

- CC\*** 2 Normally closed (DPST version)
- OC\*** 1 Normally open/ 1 Normally closed (DPST)

\* Please contact technical support for this configuration

## TAPE AND REEL

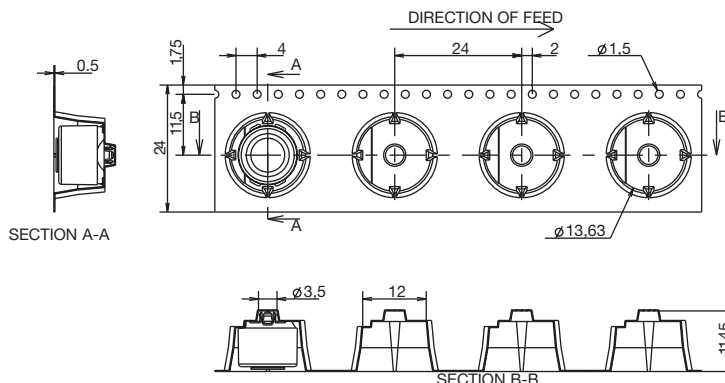

Dimensions are shown: mm  
Specifications and dimensions subject to change