

For Air-Conditioner Fan Motor

3-Phase Brushless Fan Motor Driver

BM6244FS

General Description

This 3-phase Brushless Fan motor driver IC adopts MOSFET as the output transistor, and put in a small full molding package with the 150°/120° commutation controller chip and the high voltage gate driver chip. The protection circuits for overcurrent, overheating, under voltage lock out and the high voltage bootstrap diode with current regulation are built-in. It provides downsizing the built-in PCB of the motor.

Features

- 250V MOSFET Built-in
- Output Current 2.0A
- Bootstrap operation by floating high side driver (including diode)
- 150°/120° Selectable Commutation Logic
- PWM Control (Upper arm switching)
- Phase control supported from 0° to +30° at 1° intervals
- Rotational Direction Switch
- FG signal output with pulse number switch (4 or 12)
- VREG Output (5V/30mA)
- Protection circuits provided: CL, OCP, TSD, UVLO, MLP and the external fault input
- Fault Output (open drain)

Applications

- Air Conditioners; Air Purifiers; Water Pumps; Dishwashers; Washing Machines

Key Specifications

- Output MOSFET Voltage: 250V
- Driver Output Current (DC): ±2.0A (Max)
- Driver Output Current (Pulse): ±4.0A (Max)
- Output MOSFET DC On Resistance: 0.93Ω (Typ)
- Duty Control Voltage Range: 2.1V to 5.4V
- Phase Control Range: 0° to +30°
- Maximum Junction Temperature: +150°C

Package

SSOP-A54_36A W(Typ) x D(Typ) x H(Max)
22.0mm x 14.1mm x 2.4mm

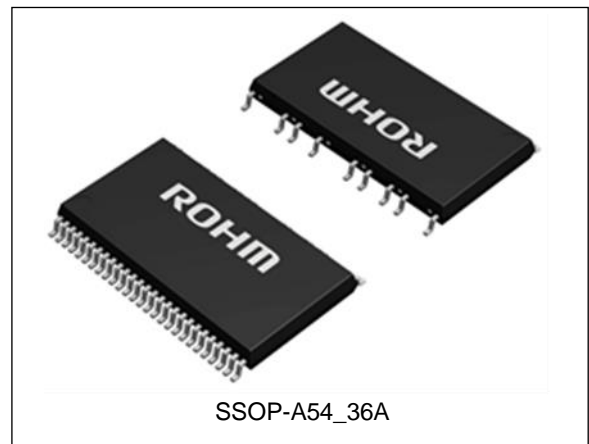

Typical Application Circuit

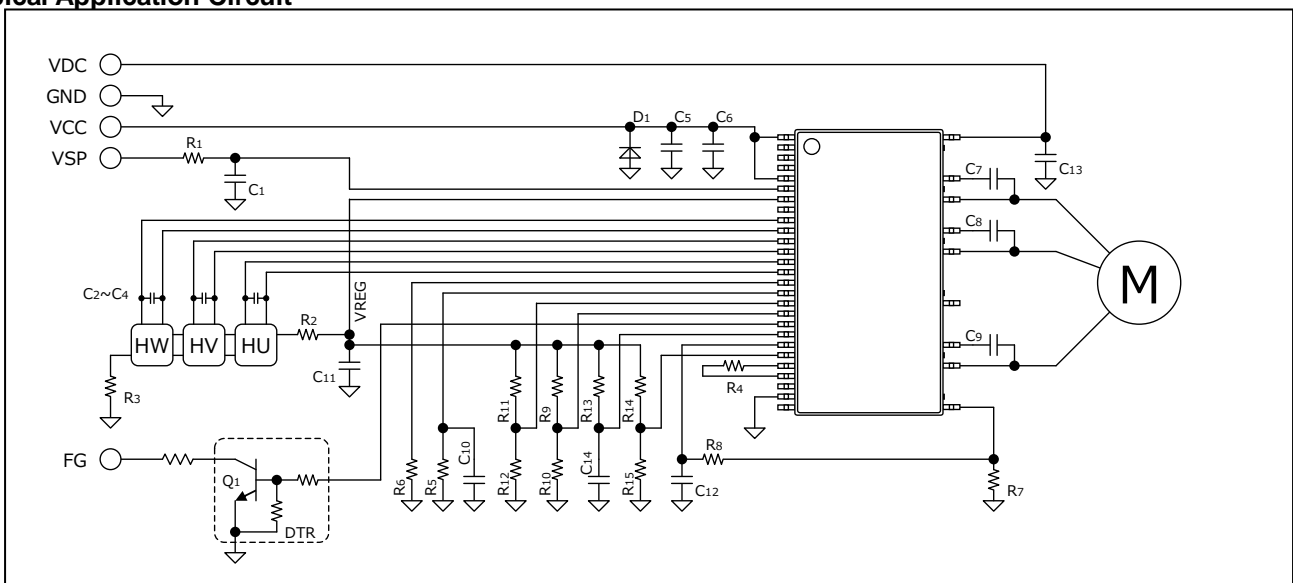

Figure 1. Application Circuit Example

○Product structure : Semiconductor IC ○This product has no designed protection against radioactive rays

Contents

General Description	1
Features	1
Applications	1
Key Specifications.....	1
Package	1
Typical Application Circuit.....	1
Contents.....	2
Block Diagram and Pin Configuration.....	3
Pin Description.....	3
Description of Blocks.....	4
Controller Outputs and Operation Mode Summary	9
Absolute Maximum Ratings	10
Thermal Resistance	10
Recommended Operating Conditions	11
Electrical Characteristics (Driver part)	11
Electrical Characteristics (Controller part)	12
Typical Performance Curves	13
Timing Chart	21
Application Example.....	25
Parts List	25
Dummy Pin Descriptions	26
I/O Equivalent Circuits.....	27
Operational Notes	28
Ordering Information	30
Marking Diagrams.....	30
Physical Dimension and Packing Information	31
Revision History.....	32

Block Diagram and Pin Configuration

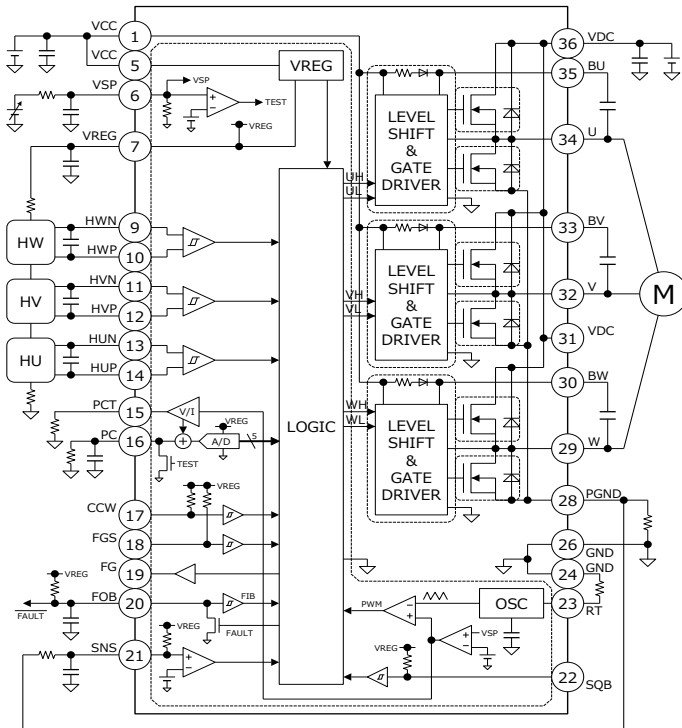

Figure 2. Block Diagram

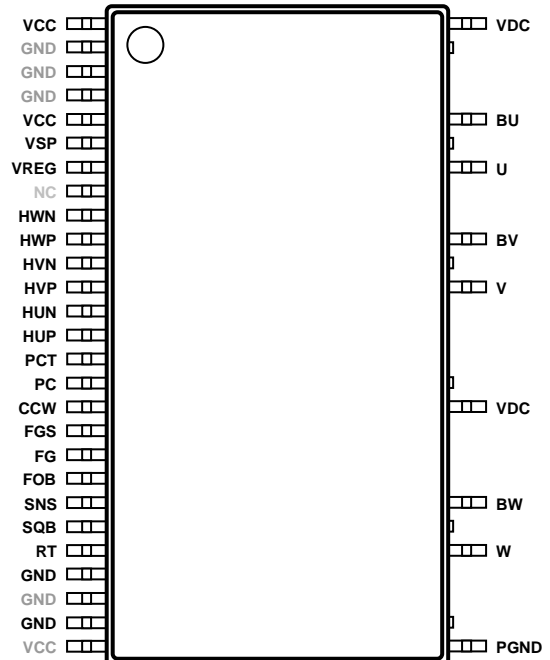

Figure 3. Pin Configuration (Top View)

Pin Description

Pin	Name	Function	Pin	Name	Function
1	VCC	Low voltage power supply	36	VDC	High voltage power supply
2	GND	Ground	-	VDC	
3	GND	Ground			
4	GND	Ground			
5	VCC	Low voltage power supply	35	BU	Phase U floating power supply
6	VSP	Duty control voltage input pin	-	U	
7	VREG	Regulator output	34	U	Phase U output
8	NC	No connection			
9	HWN	Hall input pin phase W-			
10	HWP	Hall input pin phase W+	33	BV	Phase V floating power supply
11	HVN	Hall input pin phase V-	-	V	
12	HVP	Hall input pin phase V+	32	V	Phase V output
13	HUN	Hall input pin phase U-			
14	HUP	Hall input pin phase U+			
15	PCT	VSP offset voltage output pin			
16	PC	Phase control input pin	-	VDC	
17	CCW	Direction switch (H:CCW)	31	VDC	High voltage power supply
18	FGS	FG pulse # switch (H:12, L:4)			
19	FG	FG signal output			
20	FOB	Fault signal output (open drain)			
21	SNS	Over current sense pin	30	BW	Phase W floating power supply
22	SQB	Commutation switch (L:120°)	-	W	
23	RT	Carrier frequency setting pin	29	W	Phase W output
24	GND	Ground			
25	GND	Ground			
26	GND	Ground	-	PGND	
27	VCC	Low voltage power supply	28	PGND	Ground (current sense pin)

Note) All pin cut surfaces visible from the side of package are no connected, except the pin number is expressed as a "-".

Description of Blocks

1. Commutation Logic

When the hall frequency is about 1.4Hz or less (e.g. when the motor starts up), the commutation mode is 120° square wave drive with upper and lower switching (no lead angle). The controller monitors the hall frequency, and switches to 120° commutation drive with upper switching (SQB pin is "L") or 150° commutation drive (SQB pin is "H") when the hall frequency reaches or exceeds about 1.4Hz over four consecutive cycles.

[Refer to the timing charts in Figures 46, 47, 48 and 49.](#)

2. Duty Control

The switching duty can be controlled by forcing DC voltage with value from V_{SPMIN} to V_{SPMAX} to the VSP pin. When the VSP voltage is V_{SPTST} or more, the controller forces PC pin voltage to ground (Testing mode, maximum duty and no lead angle). The VSP pin is pulled down internally by a 200 kΩ resistor. Therefore, note the impedance when setting the VSP voltage with a resistance voltage divider.

3. Carrier Frequency Setting

The carrier frequency setting can be freely adjusted by connecting an external resistor between the RT pin and ground. The RT pin is biased to a constant voltage, which determines the charge current to the internal capacitor. Carrier frequencies can be set within a range from about 16 kHz to 50 kHz. Refer to the formula to the right.

$$f_{osc}[\text{kHz}] = \frac{400}{R_T[\text{k}\Omega]}$$

4. FG Signal Output

The number of FG output pulses can be switched in accordance with the number of poles and the rotational speed of the motor. The FG signal is output from the FG pin. The 12-pulse signal is generated from the three hall signals (exclusive NOR), and the 4-pulse signal is the same as hall U signal. It is recommended to pull up FGS pin to VREG voltage when malfunctioning because of the noise.

FGS	No. of pulse
H	12
L	4

5. Direction of Motor Rotation Setting

The direction of rotation can be switched by the CCW pin. When CCW pin is "H" or open, the motor rotates at CCW direction. When the real direction is different from the setting, the commutation mode is 120° square wave drive (no lead angle). It is recommended to pull up CCW pin to VREG voltage when malfunctioning because of the noise.

CCW	Direction
H	CCW
L	CW

6. Commutation Mode

The commutation mode can be switched by the SQB pin. When SQB pin is "H" or open, the commutation mode is 150° upper arm switching. When SQB pin is "L", the commutation mode is 120° upper arm switching. It is recommended to pull up SQB pin to VREG voltage when malfunctioning because of the noise.

SQB	Commutation
H	150°
L	120°

7. Hall Signal Comparator

The hall comparator provides voltage hysteresis to prevent noise malfunctions. The bias current to the hall elements should be set to the input voltage amplitude from the element, at a value is the minimum input voltage ($V_{HALLMIN}$) or more. We recommend connecting a ceramic capacitor with value from 100 pF to 0.01 μF, between the differential input pins of the hall comparator. Note that the bias to hall elements must be set within the common mode input voltage range V_{HALLCM} .

Description of Blocks - continued

8. Output Duty Pulse Width Limiter

Pulse width duty is controlled during PWM switching in order to ensure the operation of internal power transistor. The controller doesn't output pulse of less than t_{MIN} (0.8 μ s minimum) nor output a duty pulse of D_{MAX} or more. Dead time is forcibly provided to prevent external power transistors from turning on simultaneously in upper and lower side in driver output (for example, UH and UL) of each arm. This will not overlap the minimum time t_{DT} (1.6 μ s minimum). Because of this, the maximum duty of 120° square wave drive at start up is 84% (typical).

9. Phase Control Setting

The driving signal phase can be advanced to the hall signal for phase control. The lead angle is set by forcing DC voltage to the PC pin. The input voltage is converted digitally by a 6-bit A/D converter, in which internal VREG voltage is assumed to be full-scale, and the converted data is processed by a logic circuit. The lead angle can be set from 0° to +30° at 1° intervals, and updated fourth hall cycle of phase W falling edge. Phase control function only operates at 150° commutation mode. However, the controller forces PC pin voltage to ground (no lead angle) during testing mode. The VSP offset voltage (Figure 32) is buffered to PCT pin, to connect an external resistor between PCT pin and ground. The internal bias current is determined by PCT voltage and the resistor value (V_{PCT} / R_{PCT}), and mixed to PC pin. PC pin voltage is $V_{PC} = V_{PCT} / R_{PCT} \times R_{PCL}$. As a result, the lead angle setting is followed with the duty control voltage, and the performance of the motor can be improved. Select the R_{PCT} value from 50 k Ω to 200 k Ω in the range on the basis of 100 k Ω , because the PCT pin current capability is a 100 μ A or less.

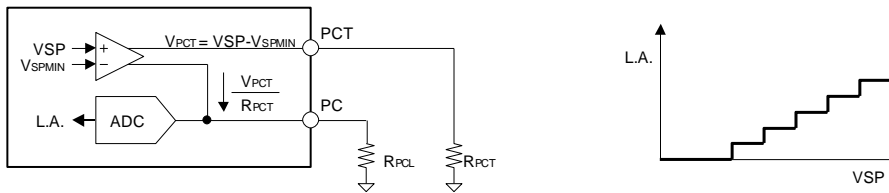

Figure 4. Phase Control Setting Example 1

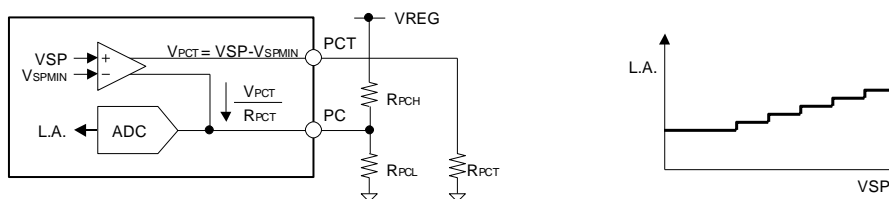

Figure 5. Phase Control Setting Example 2

10. Current Limiter (CL) Circuit and Overcurrent Protection (OCP) Circuit

The current limiter circuit can be activated by connecting a low value resistor for current detection between the output stage ground (PGND) and the controller ground (GND). When the SNS pin voltage reaches or surpasses the threshold value (V_{SNS} , 0.5V typical), the controller forces all the upper switching arm inputs low (UH, VH, WH = L, L, L), thus initiating the current limiter operation. When the SNS pin voltage swings below the ground, it is recommended to insert a resistor (1.5 k Ω or more) between SNS pin and PGND pin to prevent malfunction. Since this limiter circuit is not a latch type, it returns to normal operation - synchronizing with the carrier frequency - once the SNS pin voltage falls below the threshold voltage. A filter is built into the overcurrent detection circuit to prevent malfunctions, and does not activate when a short pulse of less than t_{MASK} is present at the input.

When the SNS pin voltage reaches or surpasses the threshold value (V_{OVER} , 0.9V typical) because of the power fault or the short circuit except the ground fault, the gate driver outputs low to the gate of all output MOSFETs, thus initiating the overcurrent protection operation. Since this protection circuit is also not a latch type, it returns to normal operation synchronizing with the carrier frequency.

Description of Blocks - continued

11. Under Voltage Lock Out (UVLO) Circuit

To secure the lowest power supply voltage necessary to operate the controller and the driver, and to prevent under voltage malfunctions, the UVLO circuits are independently built into the upper side floating driver, the lower side driver and the controller. When the supply voltage falls to V_{UVL} and below, the controller forces driver outputs low. When the voltage rises to V_{UVH} and above, the UVLO circuit ends the lockout operation and returns the chip only after 32 carrier frequency periods (1.6ms for the default 20kHz frequency) to normal operation. Even if the controller returns to normal operation, the output begins from the following control input signal.

The voltage monitor circuit (4.0V nominal) is built-in for the VREG voltage. Therefore, the UVLO circuit does not release operation when the VREG voltage rising is delayed behind the VCC voltage rising even if VCC voltage becomes V_{UVH} or more.

12. Thermal Shutdown (TSD) Circuit

The TSD circuit operates when the junction temperature of the controller exceeds the preset temperature (125°C nominal). At this time, the controller forces all driver outputs low. Since thermal hysteresis is provided in the TSD circuit, the chip returns to normal operation when the junction temperature falls below the preset temperature (100°C nominal). The TSD circuit is designed only to shut the IC off to prevent thermal runaway. It is not designed to protect the IC or guarantee its operation in the presence of extreme heat. Do not continue to use the IC after the TSD circuit is activated, and do not use the IC in an environment where activation of the circuit is assumed.

Moreover, it is not possible to follow the output MOSFET junction temperature rising rapidly because it is a gate driver chip that monitors the temperature and it is likely not to function effectively.

13. Motor Lock Protection (MLP) Circuit

When the controller detects the motor locking during fixed time of 4 seconds nominal when each edge of the hall signal doesn't input either, the controller forces all driver outputs low under a fixed time 20 seconds nominal, and self-returns to normal operation. This circuit is enabled if the voltage force to VSP is over the duty minimum voltage V_{SPMIN} , and note that the motor cannot start up when the controller doesn't detect the motor rotation by the minimum duty control. Even if the edge of the hall signal is inputted within range of the OFF state by this protection circuit, it is ignored. But if the VSP is forced to ground level once, the protection can be canceled immediately.

14. Hall Signal Wrong Input Detection

Hall element abnormalities may cause incorrect inputs that vary from the normal logic. When all hall input signals go high or low, the hall signal wrong input detection circuit forces all driver outputs low. And when the controller detects the abnormal hall signals continuously for four times or more motor rotation, the controller forces all driver outputs low and latches the state. It is released if the duty control voltage VSP is forced to ground level once.

15. VREG Output

The internal voltage regulator VREG is output for the bias of the hall element and the phase control setting. However, when using the VREG function, be aware of the I_{OMAX} value. If a capacitor is connected to the ground in order to stabilize output, a value of 1 μ F or more should be used. In this case, be sure to confirm that there is no oscillation in the output.

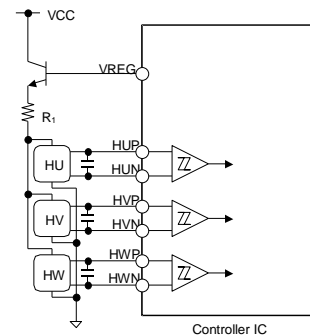

Figure 6. VREG Output Pin Application Example

Description of Blocks - continued

16. Fault Signal Output

When the controller detects either state that should be protected the overcurrent (OCP) and the over temperature (TSD), the FOB pin outputs low (open drain) and it returns to normal operation synchronizing with the carrier frequency. Even when this function is not used, be pull-up the FOB pin to the voltage of 3V or more and at least a resistor with a value 10k Ω or more. A filter is built into the fault signal input circuit to prevent malfunctions by the switching noise, and does not activate when a short pulse of less than t_{MASK} is present at the input. The time to the fault operation is the sum total of the propagation delay time of the detection circuit and the filter time, 1.6μs (typical).

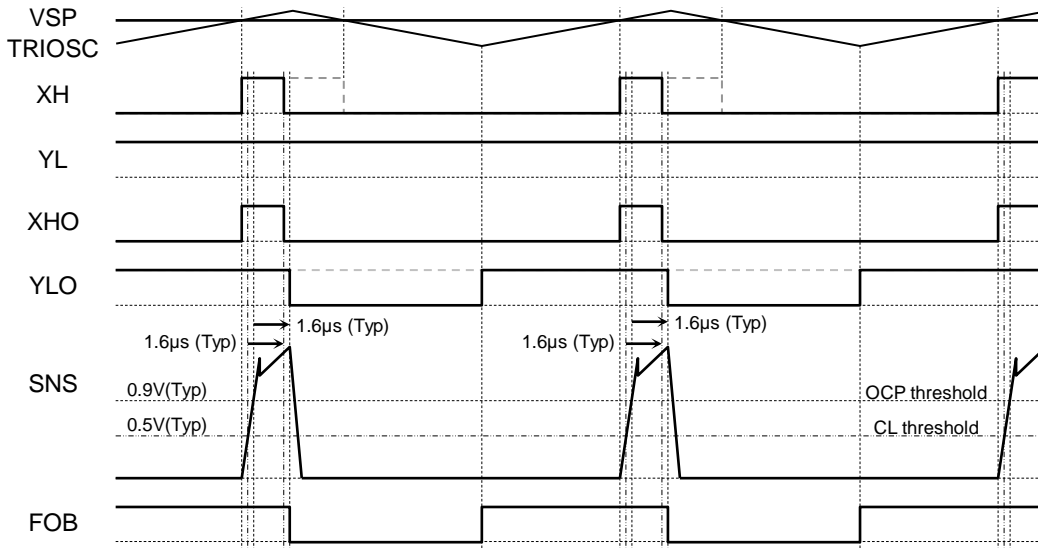

Figure 7. Fault Operation ~ OCP ~ Timing Chart

The release time from the protection operation can be changed by inserting an external capacitor. Refer to the formula below. Release time of 5ms or more is recommended.

$$t = -\ln\left(1 - \frac{2.3}{V_{REG}}\right) \cdot R \cdot C \text{ [s]}$$

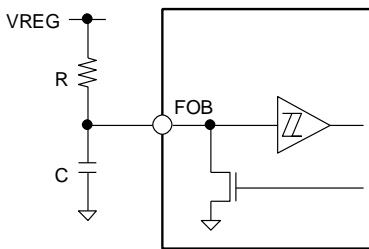

Figure 8. Release Time Setting Application Circuit

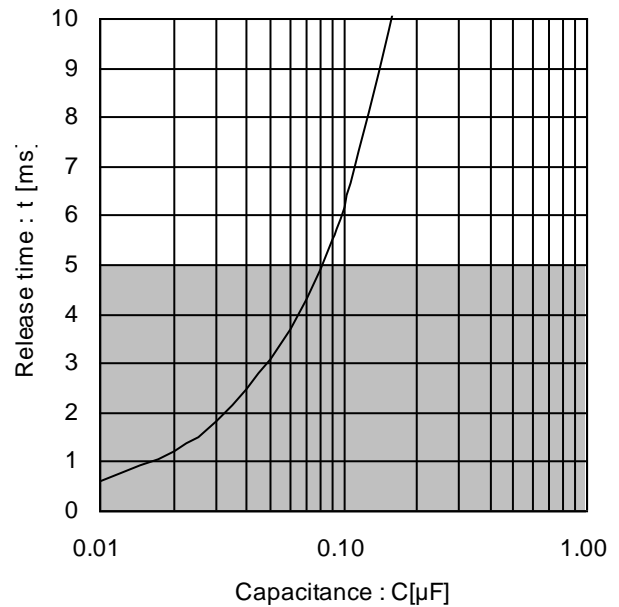

Figure 9. Release Time (Reference Data @R=100kΩ)

Description of Blocks - continued

17. Bootstrap Operation

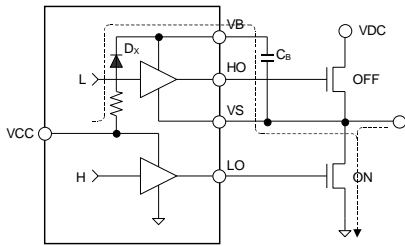

Figure 10. Charging Period

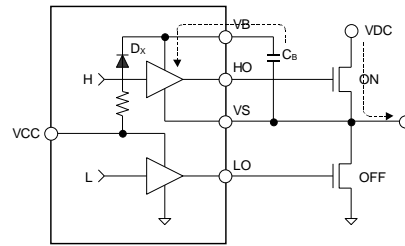

Figure 11. Discharging Period

The bootstrap is operated by the charge period and the discharge period being alternately repeated for bootstrap capacitor (C_B) as shown in the figure above. In a word, this operation is repeated while the output of an external transistor is switching with synchronous rectification. Because the supply voltage of the floating driver is charged from the VCC power supply to C_B through prevention of backflow diode D_X , it is approximately $(VCC-1V)$. The resistance series connection with D_X has the impedance of approximately 200Ω . Because the total gate charge is needed only by the carrier frequency in the upper switching section of 120° commutation driving, set it after confirming actual application operation.

18. Switching Time

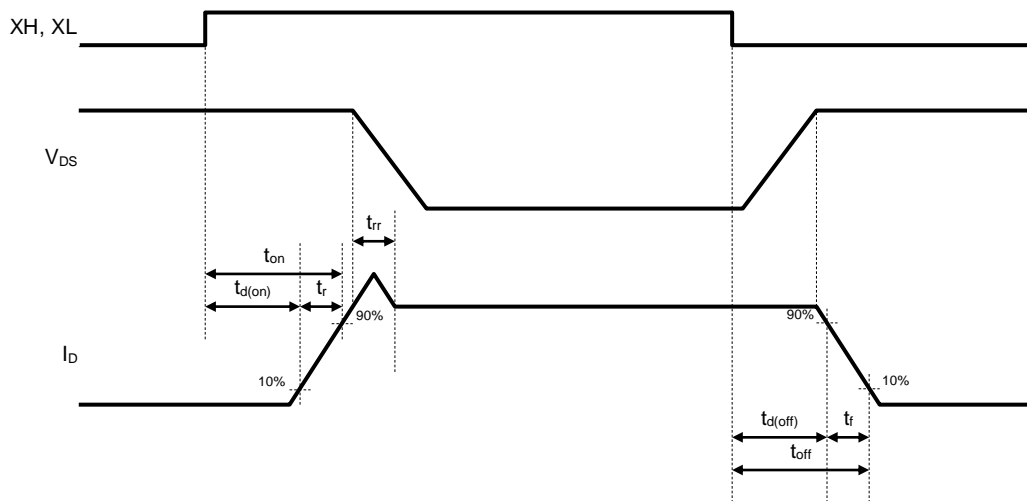

Figure 12. Switching Time Definition

Parameter	Symbol	Reference	Unit	Conditions
High Side Switching Time	$t_{dH(on)}$	800	ns	VDC=150V, VCC=15V, I _D =1.0A Inductive load
	t_{rH}	140	ns	
	t_{rrH}	300	ns	
	$t_{dH(off)}$	480	ns	
	t_{fH}	30	ns	
Low Side Switching Time	$t_{dL(on)}$	750	ns	The propagation delay time: Internal gate driver input stage to the driver IC output.
	t_{rL}	130	ns	
	t_{rrL}	280	ns	
	$t_{dL(off)}$	400	ns	
	t_{fL}	30	ns	

Controller Outputs and Operation Mode Summary

Conditions	Detected direction	Forward (CW:U~V~W, CCW:U~W~V)		Reverse (CW:U~W~V, CCW:U~V~W)	
	Hall sensor frequency	< 1.4Hz	1.4Hz ≤	< 1.4Hz	1.4Hz ≤
Normal operation	VSP < VSPMIN (Duty off)	Upper and lower arm off			
	VSPMIN < VSP < VSPMAX (Control range)	120° Upper and lower switching	150° or 120° (Note 4) Upper switching	120° Upper and lower switching	120° Upper switching
	VSPSTST < VSP (Testing mode)		150° or 120° (Note 4) Upper switching (No lead angle)		
Protect operation	Current limiter (Note 1)	Upper arm off			Upper and lower arm off
	Overcurrent (Note 2)	Upper and lower arm off			
	TSD (Note 2)				
	External input (Note 2)				
	UVLO (Note 3)				
	Motor lock				
	Hall sensor abnormally	Upper and lower arm off and latch			

(Note) The controller monitors both edges of three hall sensors for detecting period.

(Note) Phase control function only operates at 150° or 120° commutation mode with upper switching (Forward and 1.4Hz ≤). However, the controller forces no lead angle during the testing mode.

(Note 1) It returns to normal operation by the carrier frequency synchronization.

(Note 2) It works together with the fault operation, and returns after the release time synchronizing with the carrier frequency.

(Note 3) It returns to normal operation after 32 cycles of the carrier oscillation period.

(Note 4) SQB pin is commutation switch, SQB=H:150° upper switching, SQB=L:120° upper switching.

Absolute Maximum Ratings (Tj=25°C)

Parameter	Symbol	Ratings	Unit
Output MOSFET	V _{DSS}	250	V
Supply Voltage	V _{DC}	-0.3 to +250	V
Output Voltage	V _U , V _V , V _W	-0.3 to +250	V
High Side Supply Pin Voltage	V _{BU} , V _{BV} , V _{BW}	-0.3 to +250	V
High Side Floating Supply Voltage	V _{BU-VU} , V _{BV-VV} , V _{BW-VW}	-0.3 to +20	V
Low Side Supply Voltage	V _{CC}	-0.3 to +20	V
Duty Control Voltage	V _{SP}	-0.3 to +20	V
All Others	V _{IO}	-0.3 to +5.5	V
Driver Outputs (DC)	I _{OMAX(DC)}	±2.0	A
Driver Outputs (Pulse)	I _{OMAX(PLS)}	±4.0 ^(Note 1)	A
Fault Signal Output	I _{OMAX(FOB)}	15	mA
Storage Temperature	T _{stg}	-55 to +150	°C
Maximum Junction Temperature	T _{jmax}	150	°C

(Note) All voltages are with respect to ground unless otherwise specified.

(Note 1) Pw ≤ 10μs, Duty cycle ≤ 1%

Caution1: Operating the IC over the absolute maximum ratings may damage the IC. The damage can either be a short circuit between pins or an open circuit between pins and the internal circuitry. Therefore, it is important to consider circuit protection measures, such as adding a fuse, in case the IC is operated over the absolute maximum ratings.

Caution2: Should by any chance the maximum junction temperature rating be exceeded the rise in temperature of the chip may result in deterioration of the properties of the chip. In case of exceeding this absolute maximum rating, design a PCB boards with thermal resistance taken into consideration by increasing board size and copper area so as not to exceed the maximum junction temperature rating.

Thermal Resistance ^(Note 1)

Parameter	Symbol	Thermal Resistance (Typ)	Unit
		1s ^(Note 3)	
SSOP-A54_36A			
Junction to Ambient	θ _{JA}	41.7	°C/W
Junction to Top Characterization Parameter ^(Note 2)	Ψ _{JT}	10	°C/W

(Note 1) Based on JESD51-2A(Still-Air)

(Note 2) Refer to Figure 13. for temperature measurement point on the component package top surface.

(Note 3) Using a PCB board based on JESD51-3.

Layer Number of Measurement Board	Material	Board Size
Single	FR-4	114.3mm x 76.2mm x 1.57mm

Top	
Copper Pattern	Thickness
Footprints and Traces	70μm

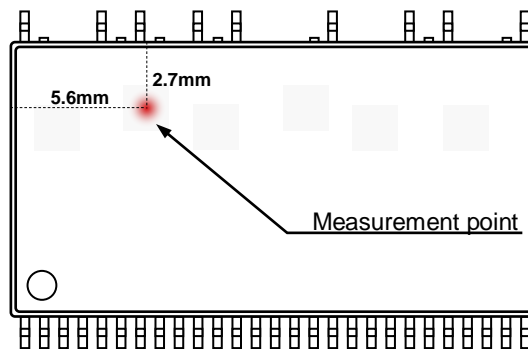

Figure 13. Temperature Measurement Point

Recommended Operating Conditions (T_j=25°C)

Parameter	Symbol	Min	Typ	Max	Unit
Supply Voltage	V _{DC}	-	140	200	V
High Side Floating Supply Voltage	V _{BU} -V _U , V _{BV} -V _V , V _{BW} -V _W	13.5	15	16.5	V
Low Side Supply Voltage	V _{CC}	13.5	15	16.5	V
Bootstrap Capacitor	C _B	1.0	-	-	μF
VCC Bypass Capacitor	C _{VCC}	1.0	-	-	μF
Shunt Resistor (PGND)	R _S	0.5	-	-	Ω
Junction Temperature	T _j	-40	-	+125	°C

(Note) All voltages are with respect to ground unless otherwise specified.

Electrical Characteristics (Driver part, Unless otherwise specified V_{CC}=15V and T_j=25°C)

Parameter	Symbol	Min	Typ	Max	Unit	Conditions
Power Supply						
HS Quiescence Current	I _{BBQ}	30	70	150	μA	VSP=0V, each phase
LS Quiescence Current	I _{CCQ}	0.2	0.7	1.3	mA	VSP=0V
Output MOSFET						
D-S Breakdown Voltage	V _{(BR)DSS}	250	-	-	V	I _D =1mA, VSP=0V
Leak Current	I _{DSS}	-	-	100	μA	V _{DS} =250V, VSP=0V
DC On Resistance	R _{DS(ON)}	-	0.93	1.30	Ω	I _D =1.0A
Diode Forward Voltage	V _{SD}	-	0.9	1.5	V	I _D =1.0A
Bootstrap Diode						
Leak Current	I _{LBD}	-	-	10	μA	V _{BX} =250V
Forward Voltage	V _{FBD}	1.5	1.8	2.1	V	I _{BD} =-5mA with series-res.
Series Resistance	R _{BD}	-	200	-	Ω	
Under Voltage Lock Out						
High Side Release Voltage	V _{BUVH}	9.5	10.0	10.5	V	V _{BX} - V _X
High Side Lockout Voltage	V _{BUVL}	8.5	9.0	9.5	V	V _{BX} - V _X

(Note) All voltages are with respect to ground unless otherwise specified.

Electrical Characteristics - continued (Controller part, Unless otherwise specified $V_{CC}=15V$ and $T_j=25^{\circ}C$)

Parameter	Symbol	Min	Typ	Max	Unit	Conditions
Power Supply						
Supply Current	I_{CC}	0.8	1.7	3.0	mA	$V_{SP}=0V$
VREG Voltage	V_{REG}	4.5	5.0	5.5	V	$I_O=-30mA$
Hall Comparators						
Input Bias Current	I_{HALL}	-2.0	-0.1	+2.0	μA	$V_{IN}=0V$
Common Mode Input	V_{HALLCM}	0.3	-	$V_{REG}-1.5$	V	
Minimum Input Level	$V_{HALLMIN}$	50	-	-	mV _{P-P}	
Hysteresis Voltage P	$V_{HALLHY+}$	5	13	23	mV	
Hysteresis Voltage N	$V_{HALLHY-}$	-23	-13	-5	mV	
Duty Control						
Input Bias Current	I_{SP}	15	25	35	μA	$V_{IN}=5V$
Duty Minimum Voltage	V_{SPMIN}	1.8	2.1	2.4	V	
Duty Maximum Voltage	V_{SPMAX}	5.1	5.4	5.7	V	
Testing Operation Range	V_{SPTST}	8.2	-	18	V	
Minimum Output Duty	D_{MIN}	-	2	-	%	$f_{OSC}=20kHz$
Maximum Output Duty	D_{MAX}	-	95	-	%	$f_{OSC}=20kHz$
Mode Switch - FGS, CCW and SQB						
Input Bias Current	I_{IN}	-70	-50	-30	μA	$V_{IN}=0V$
Input High Voltage	V_{INH}	3	-	V_{REG}	V	
Input Low Voltage	V_{INL}	0	-	1	V	
Fault Input/Output - FOB						
Input High Voltage	V_{FOBIH}	3	-	V_{REG}	V	
Input Low Voltage	V_{FOBIL}	0	-	1	V	
Output Low Voltage	V_{FOBOL}	0	0.07	0.60	V	$I_O=5mA$
Monitor Output - FG						
Output High Voltage	V_{MONH}	$V_{REG}-0.40$	$V_{REG}-0.08$	V_{REG}	V	$I_O=-2mA$
Output Low Voltage	V_{MONL}	0	0.02	0.40	V	$I_O=2mA$
Current Detection - SNS						
Input Bias Current	I_{SNS}	-30	-20	-10	μA	$V_{IN}=0V$
Current Limiter Voltage	V_{SNS}	0.48	0.50	0.52	V	
Overcurrent Voltage	V_{OVER}	0.84	0.90	0.96	V	
Noise Masking Time	t_{MASK}	0.8	1.0	1.2	μs	
Phase Control						
Minimum Lead Angle	P_{MIN}	-	0	1	deg	$V_{PC}=0V$
Maximum Lead Angle	P_{MAX}	29	30	-	deg	$V_{PC}=1/2 \cdot V_{REG}$
Carrier Frequency Oscillator						
Carrier Frequency	f_{OSC}	18	20	22	kHz	$R_T=20k\Omega$
Under Voltage Lock Out						
LS Release Voltage	V_{CCUVH}	11.5	12.0	12.5	V	
LS Lockout Voltage	V_{CCUVL}	10.5	11.0	11.5	V	

(Note) All voltages are with respect to ground unless otherwise specified.

Typical Performance Curves (Reference Data)

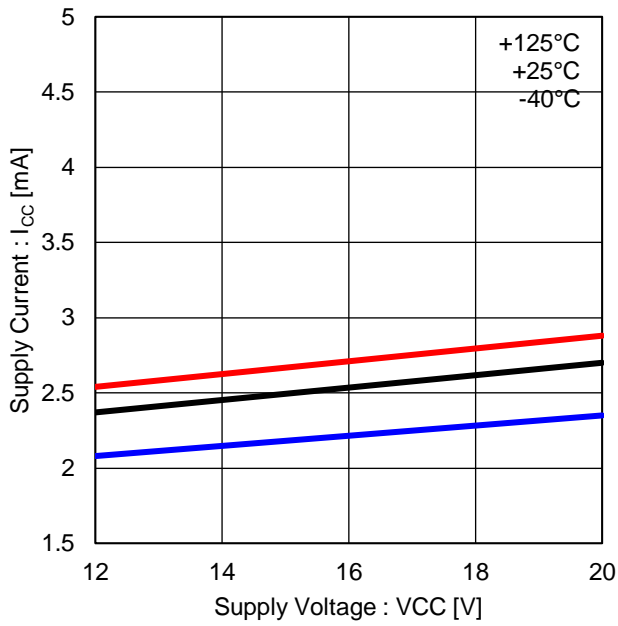

Figure 14. Quiescence Current (Low Side Drivers)

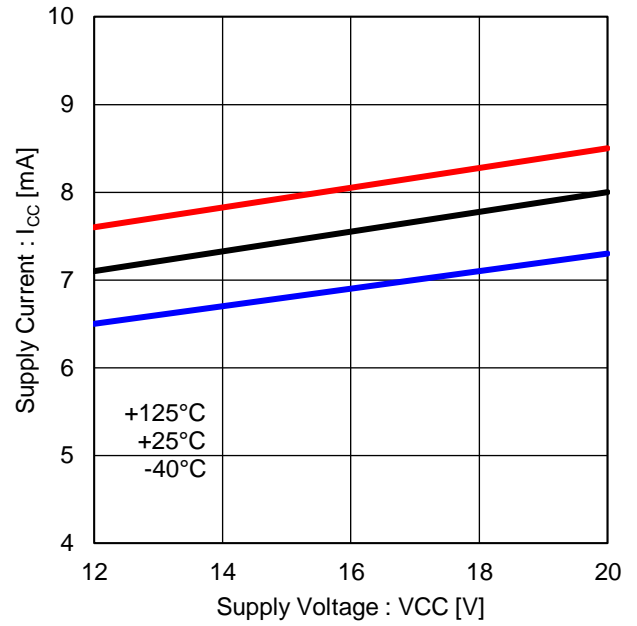

Figure 15. Low Side Drivers Operating Current (f_{PWM}: 20kHz)

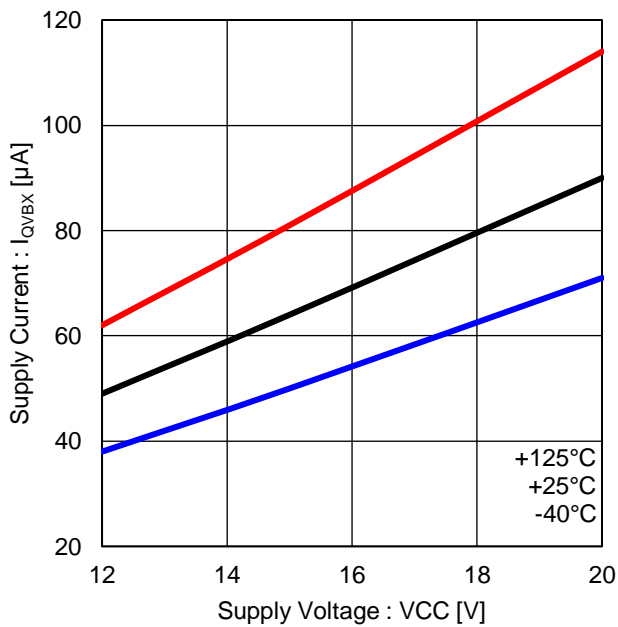

Figure 16. Quiescence Current (High Side Driver, Each Phase)

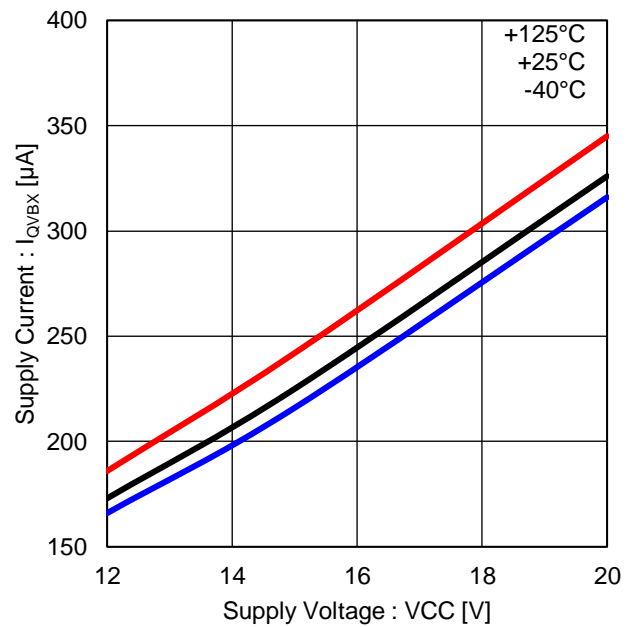

Figure 17. High Side Driver Operating Current (f_{PWM}: 20kHz, Each Phase)

Typical Performance Curves (Reference Data) - continued

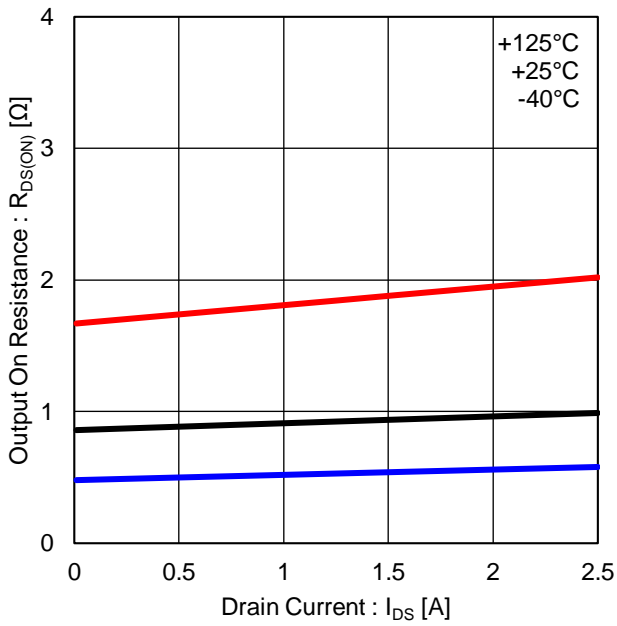

Figure 18. Output MOSFET ON Resistance

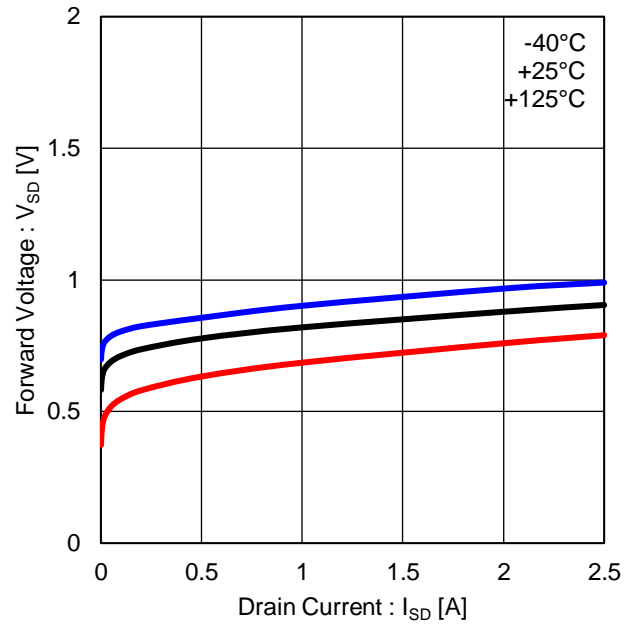

Figure 19. Output MOSFET Body Diode

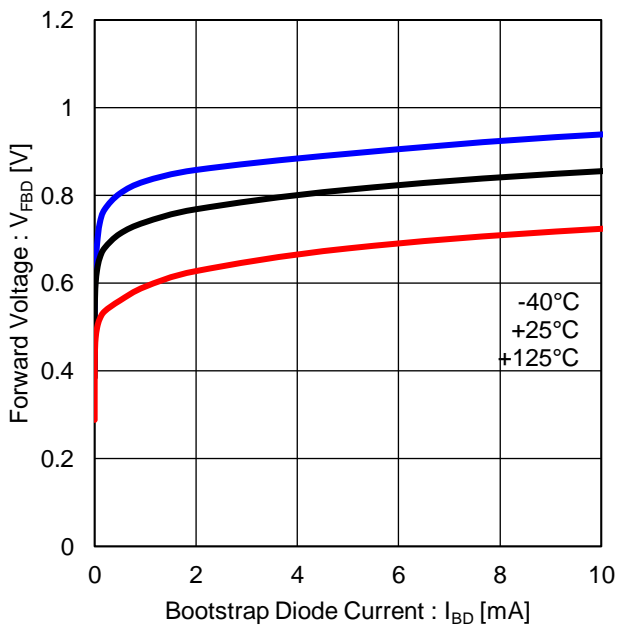

Figure 20. Bootstrap Diode Forward Voltage

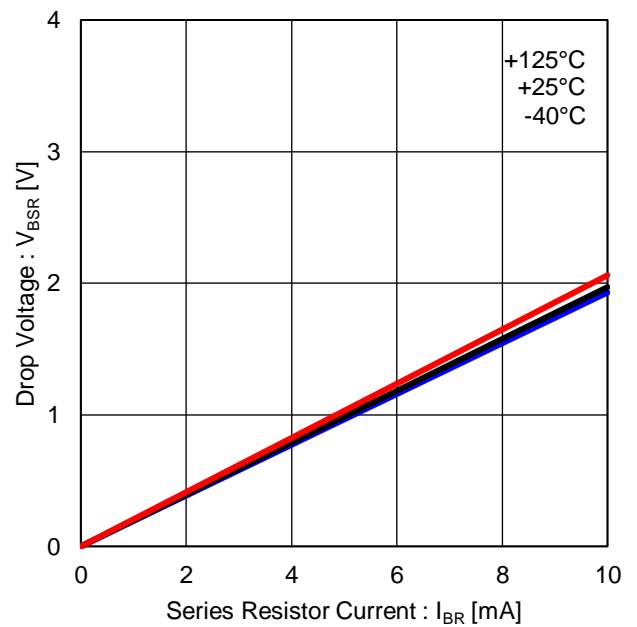

Figure 21. Bootstrap Series Resistor

Typical Performance Curves (Reference Data) - continued

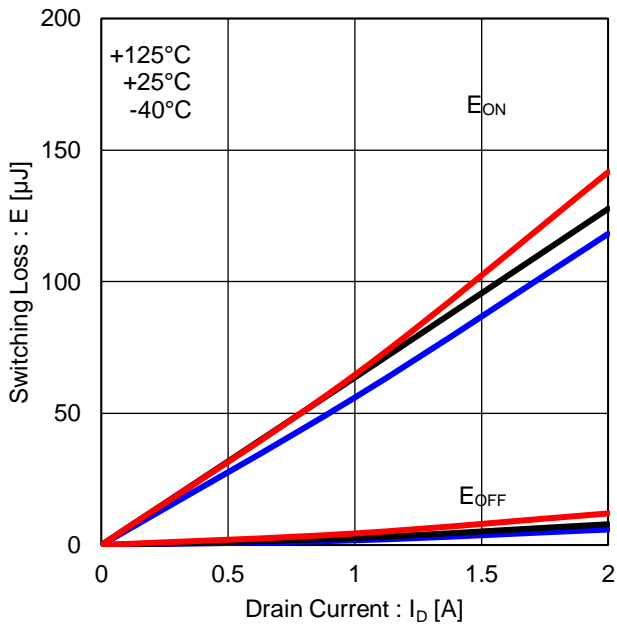

Figure 22. High Side Switching Loss (VDC=150V)

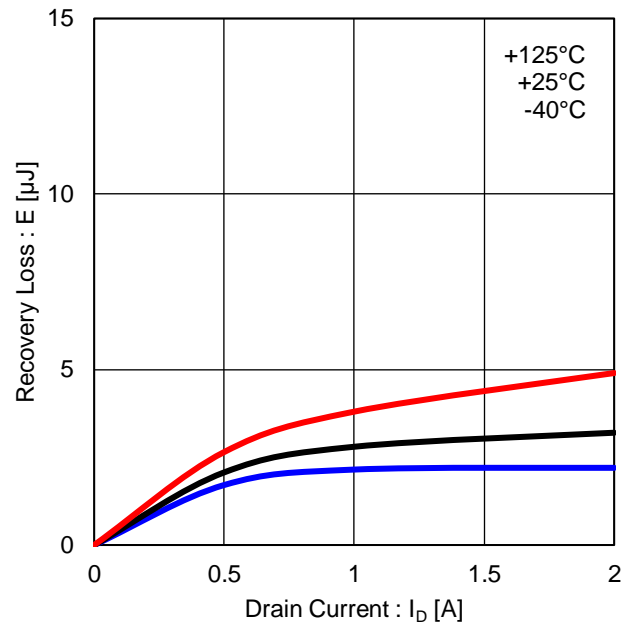

Figure 23. High Side Recovery Loss (VDC=150V)

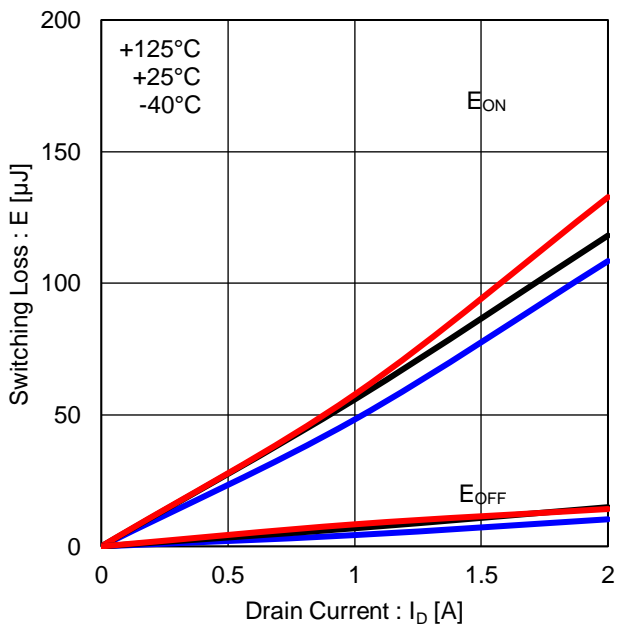

Figure 24. Low Side Switching Loss (VDC=150V)

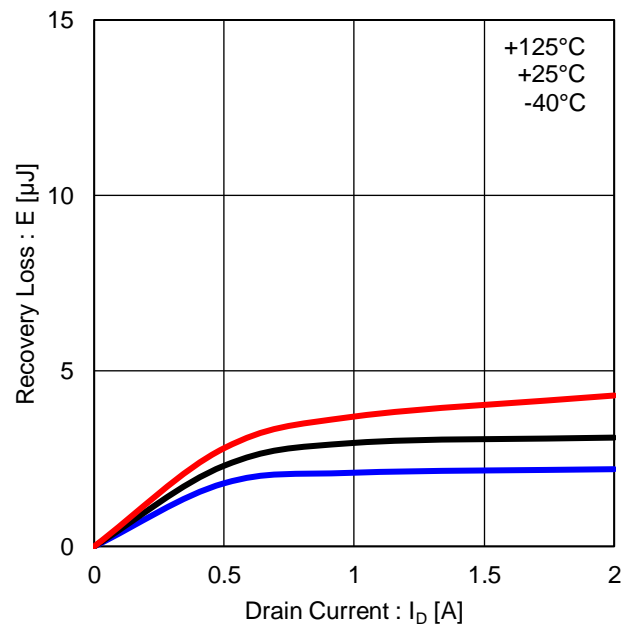

Figure 25. Low Side Recovery Loss (VDC=150V)

Typical Performance Curves (Reference Data) - continued

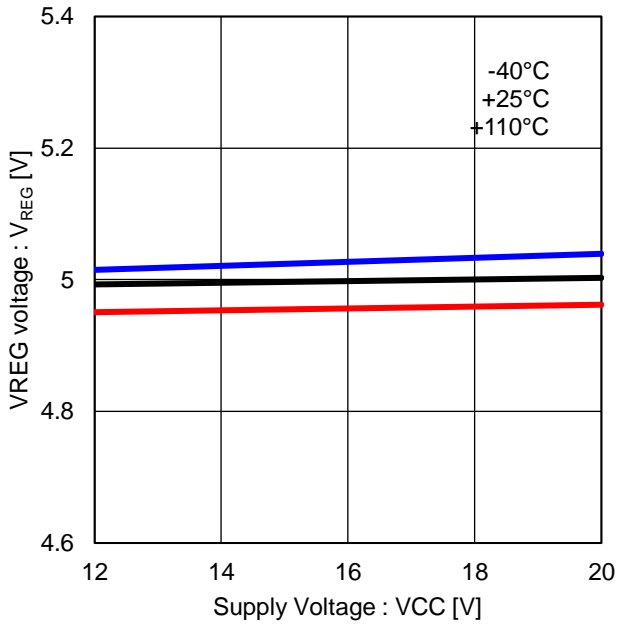

Figure 26. VREG vs VCC

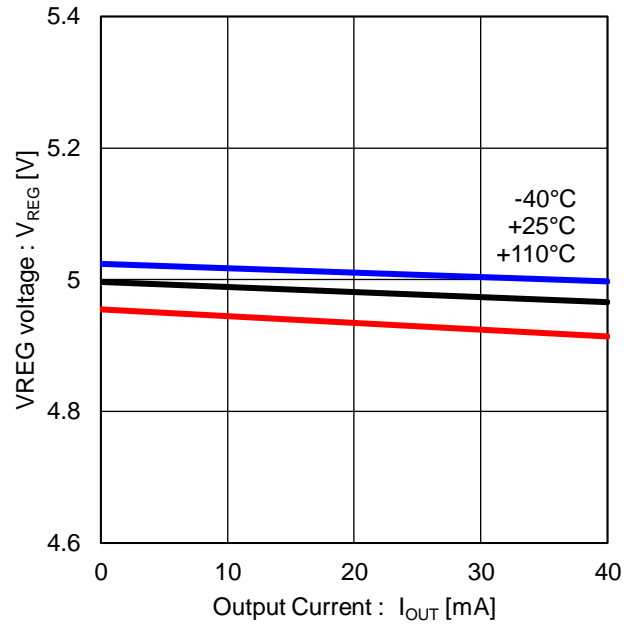

Figure 27. VREG Drive Capability

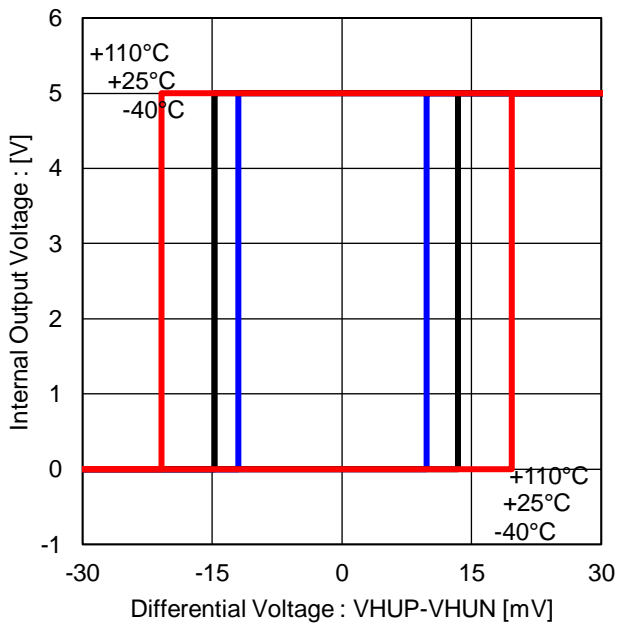

Figure 28. Hall Comparator Hysteresis Voltage

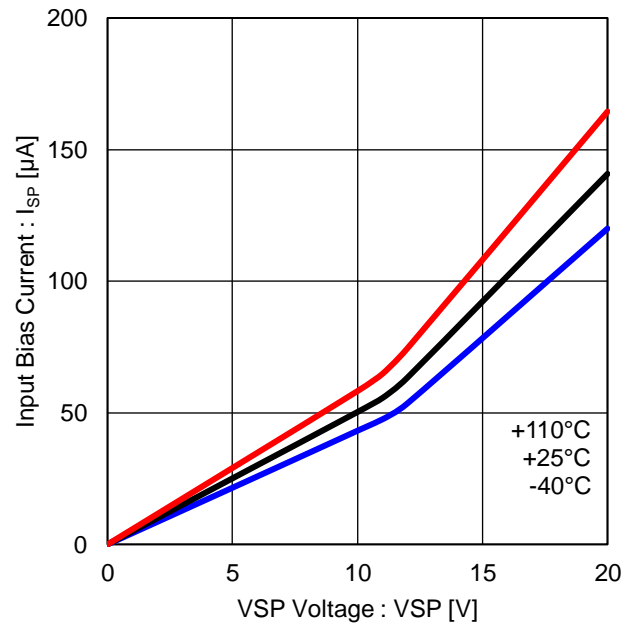

Figure 29. VSP Input Bias Current

Typical Performance Curves (Reference Data) - continued

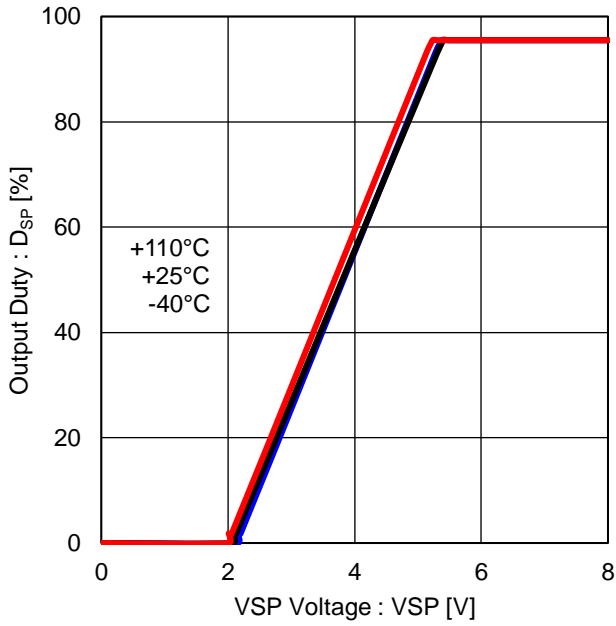

Figure 30. Output Duty vs VSP Voltage

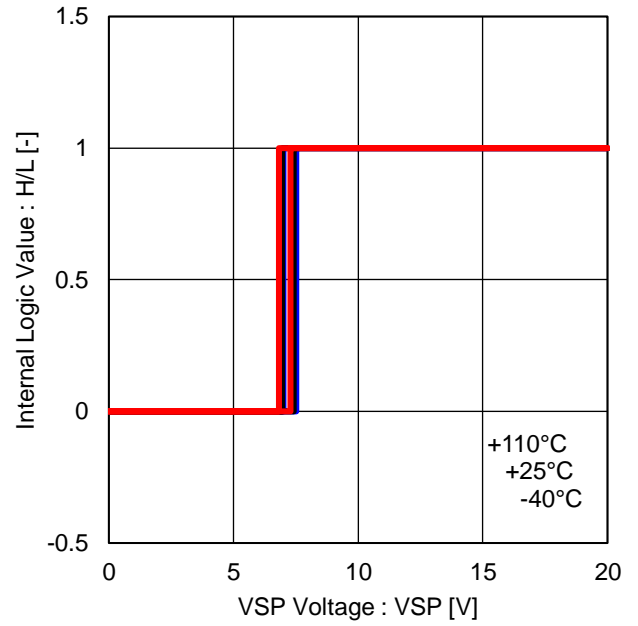

Figure 31. Testing Mode Threshold Voltage

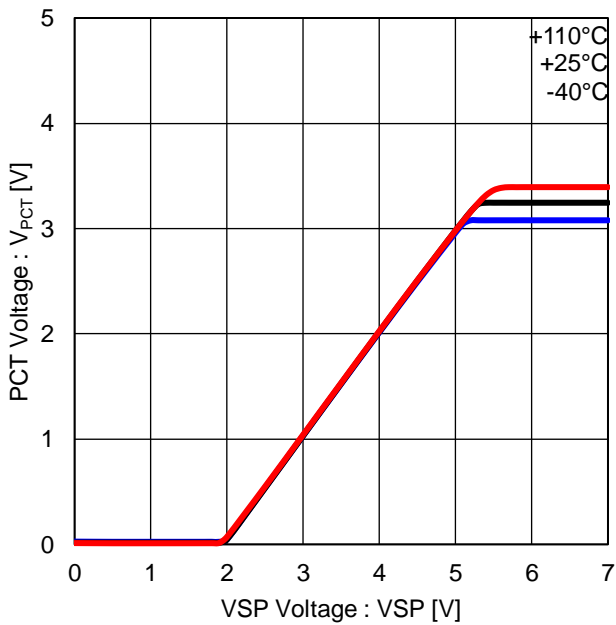

Figure 32. VSP vs PCT Offset Voltage

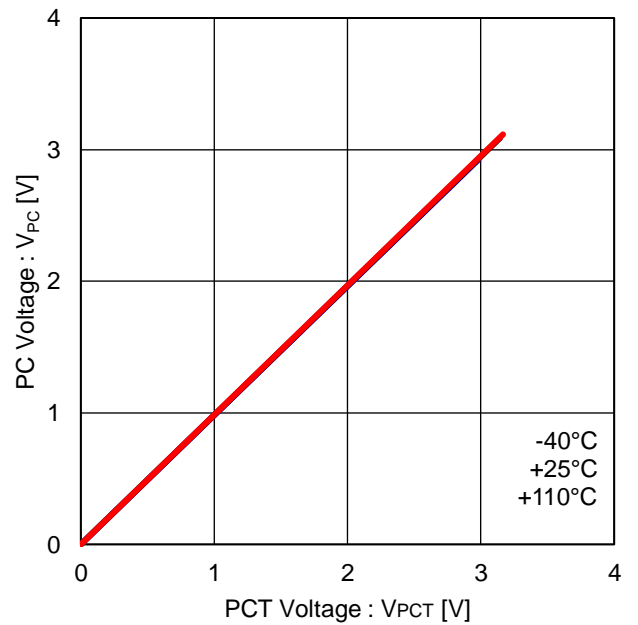

Figure 33. PCT vs PC Linearity
($R_{PCT}=R_{PC}=100k\Omega$)

Typical Performance Curves (Reference Data) - continued

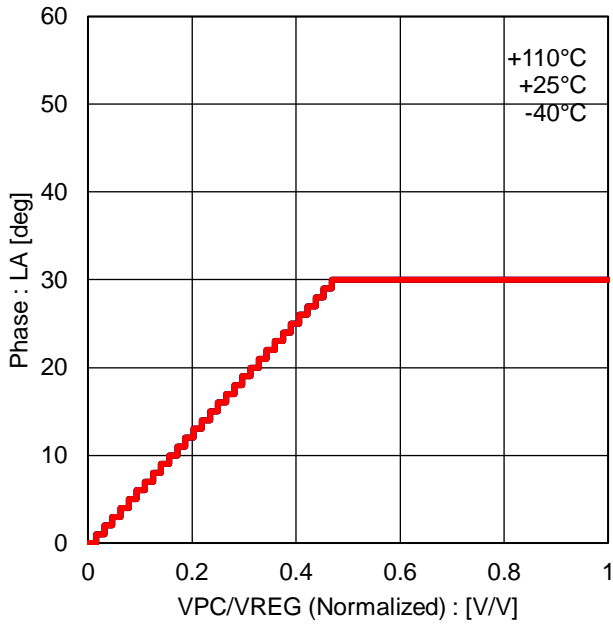

Figure 34. PC Voltage Normalized vs Lead Angle

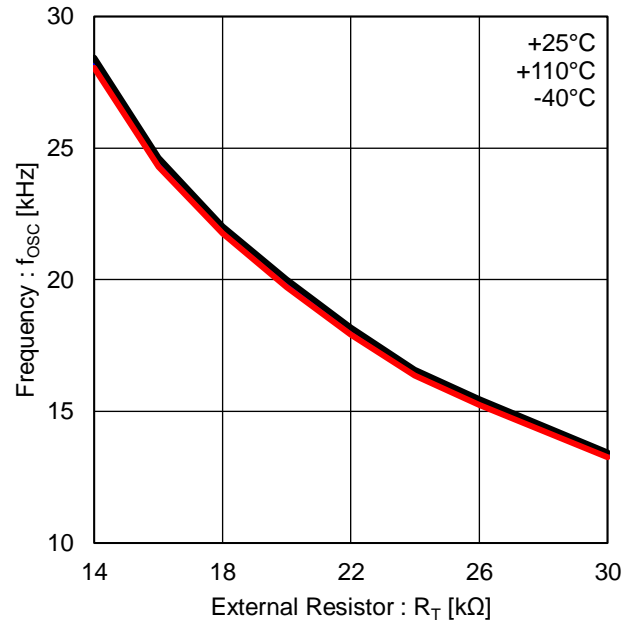

Figure 35. Carrier Frequency vs RT

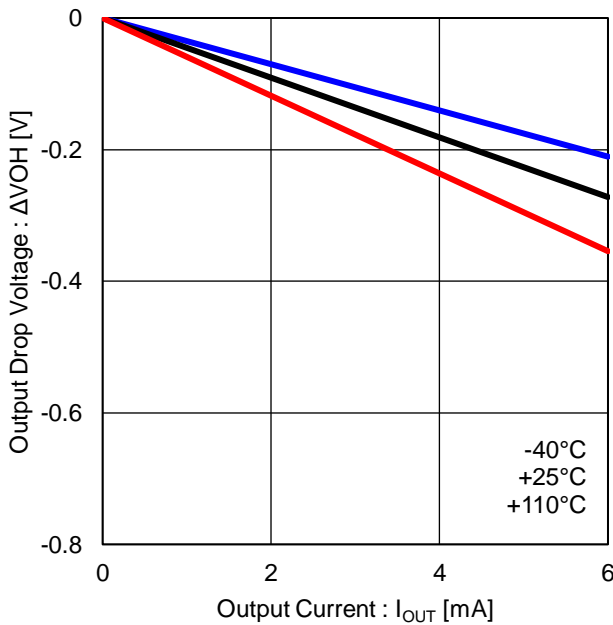

Figure 36. High Side Output Voltage (FG)

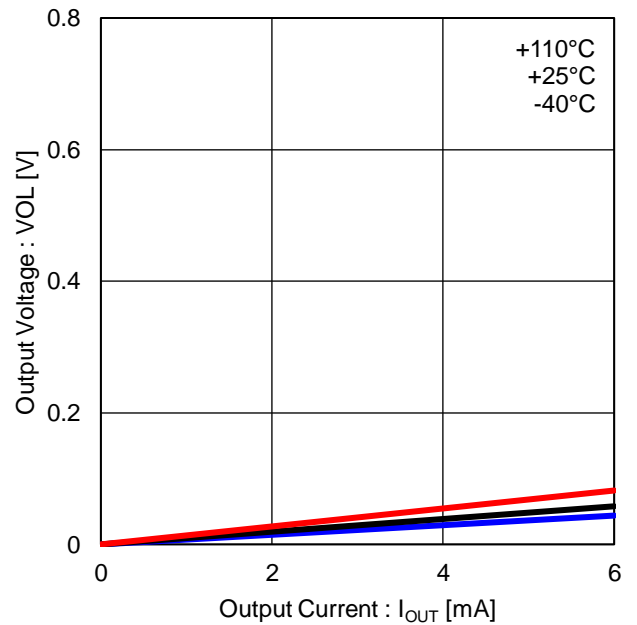

Figure 37. Low Side Output Voltage (FG)

Typical Performance Curves (Reference Data) - continued

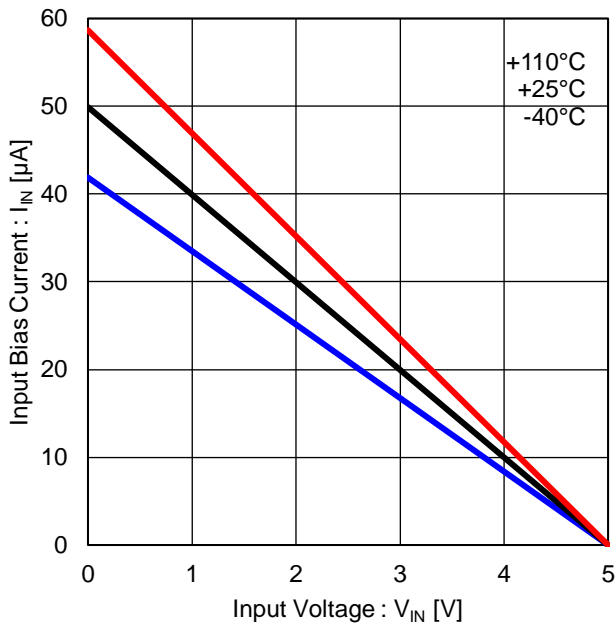

Figure 38. Input Bias Current (CCW, FGS, SQB)

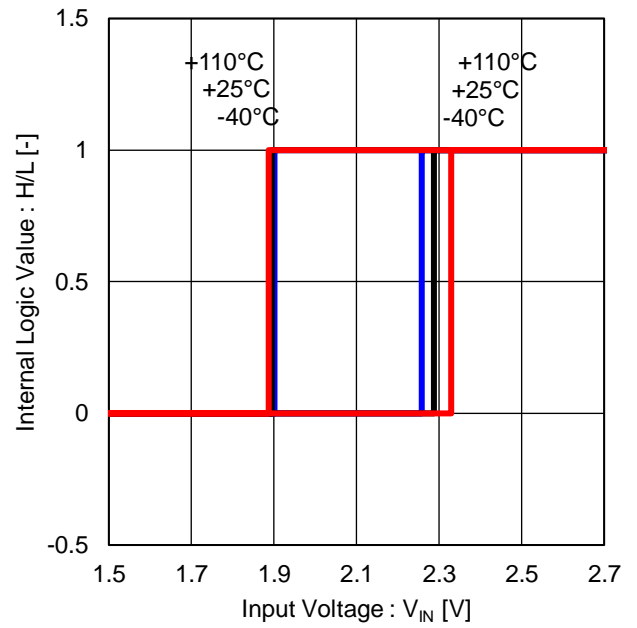

Figure 39. Input Threshold Voltage (CCW, FGS, SQB, FOB)

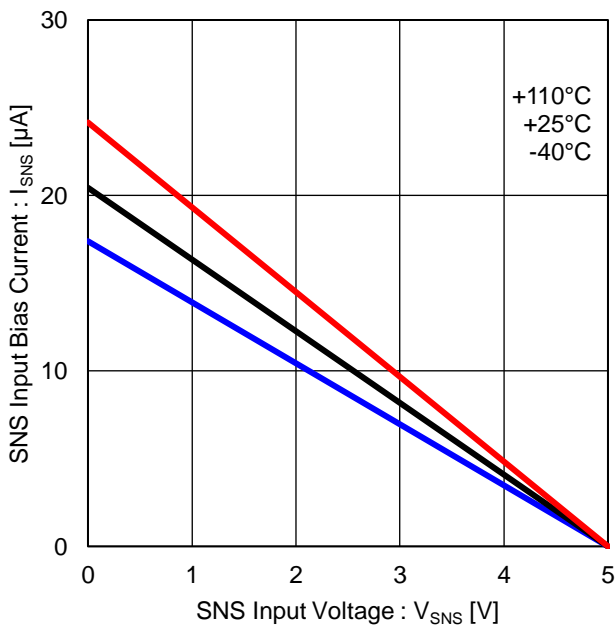

Figure 40. Input Bias Current (SNS)

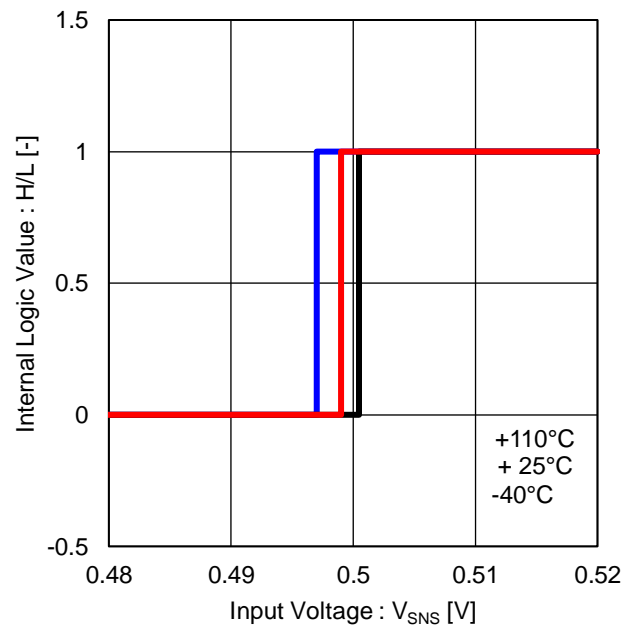

Figure 41. Current Limiter Input Threshold Voltage (SNS)

Typical Performance Curves (Reference Data) - continued

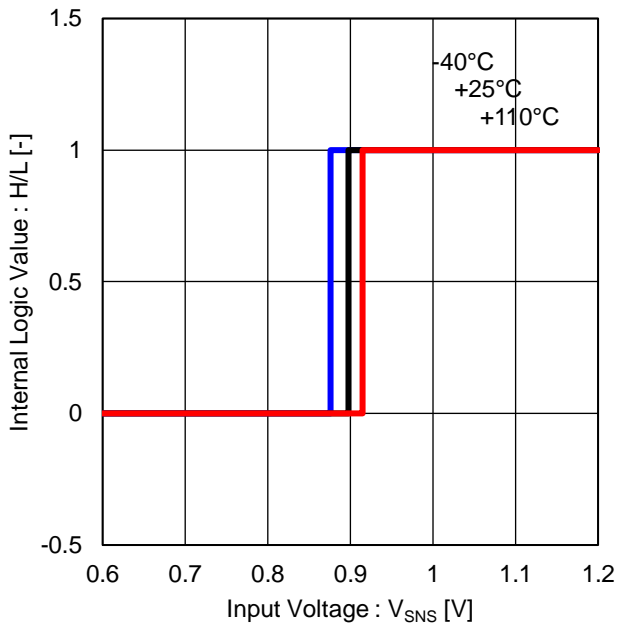

Figure 42. OCP Input Threshold Voltage (SNS)

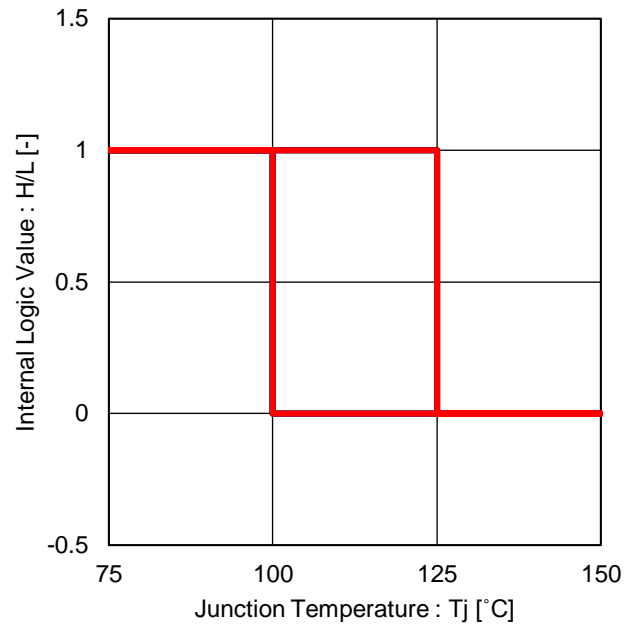

Figure 43 Thermal Shutdown

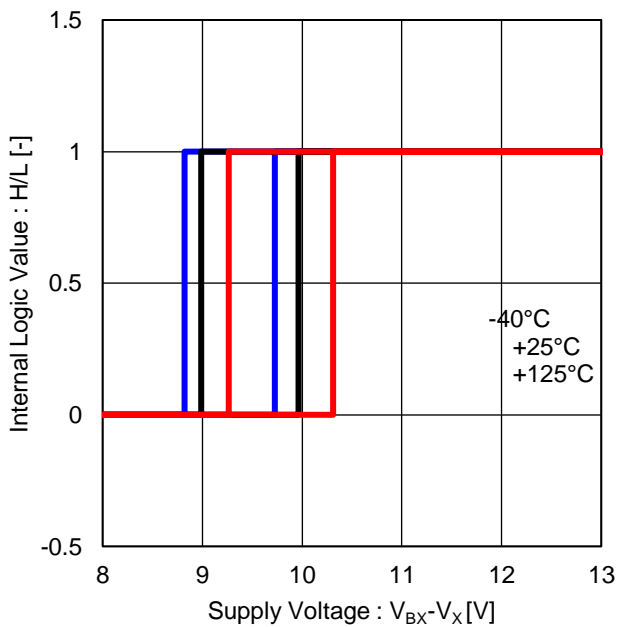

Figure 44. Under Voltage Lock Out (High Side Driver, Each Phase)

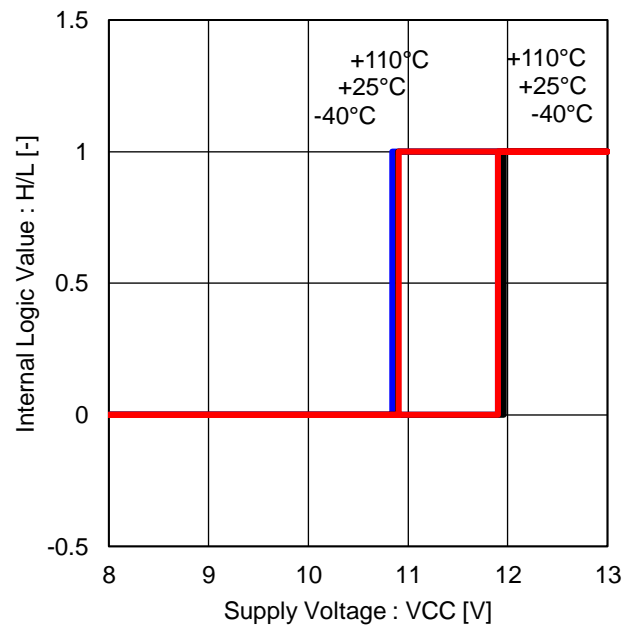

Figure 45. Under Voltage Lock Out (Low Side Drivers)

Timing Chart (CW, SQB = H)

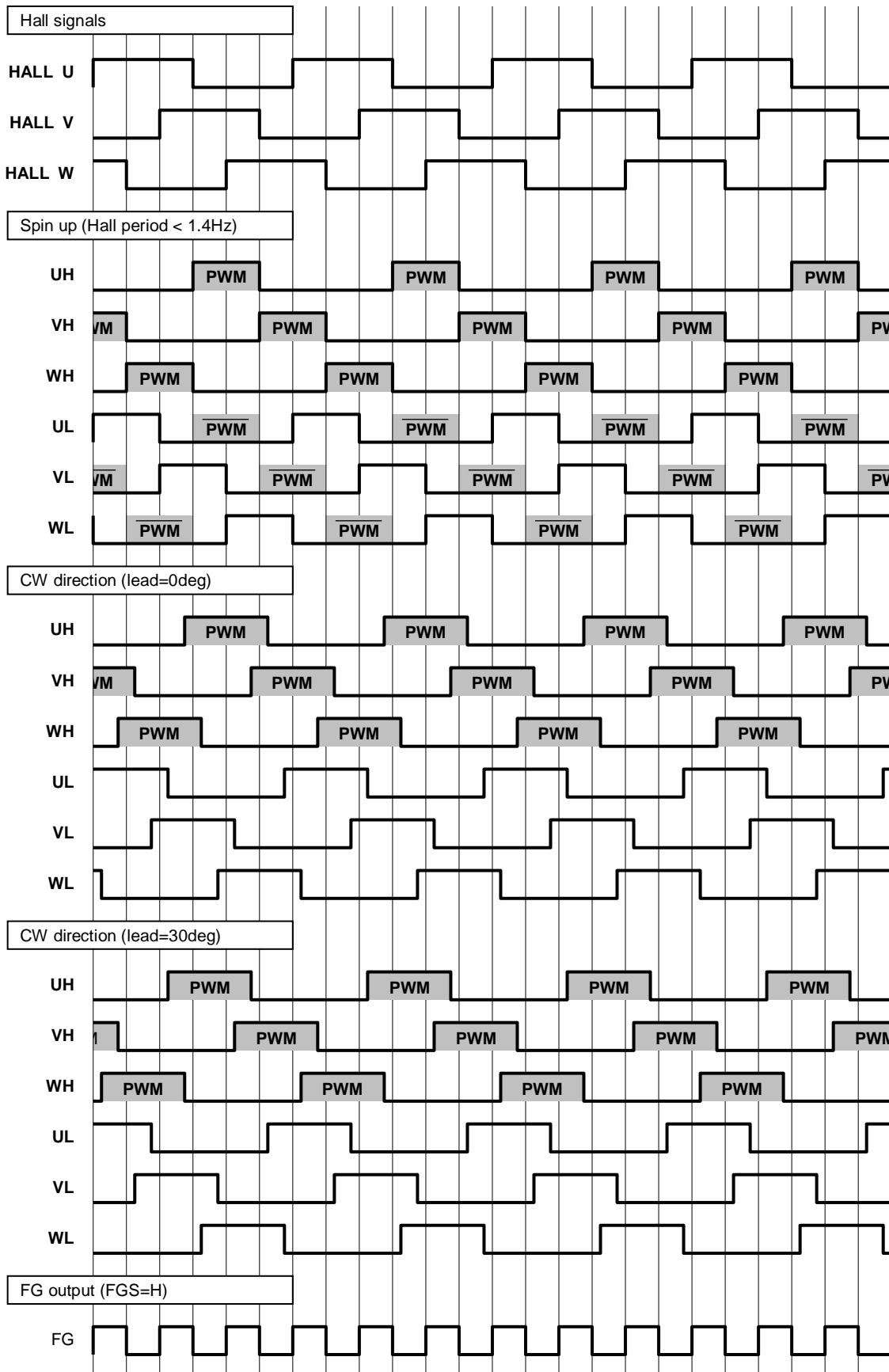

Figure 46. Timing Chart (Clockwise, SQB=H)

Timing Chart (CCW, SQB=H)

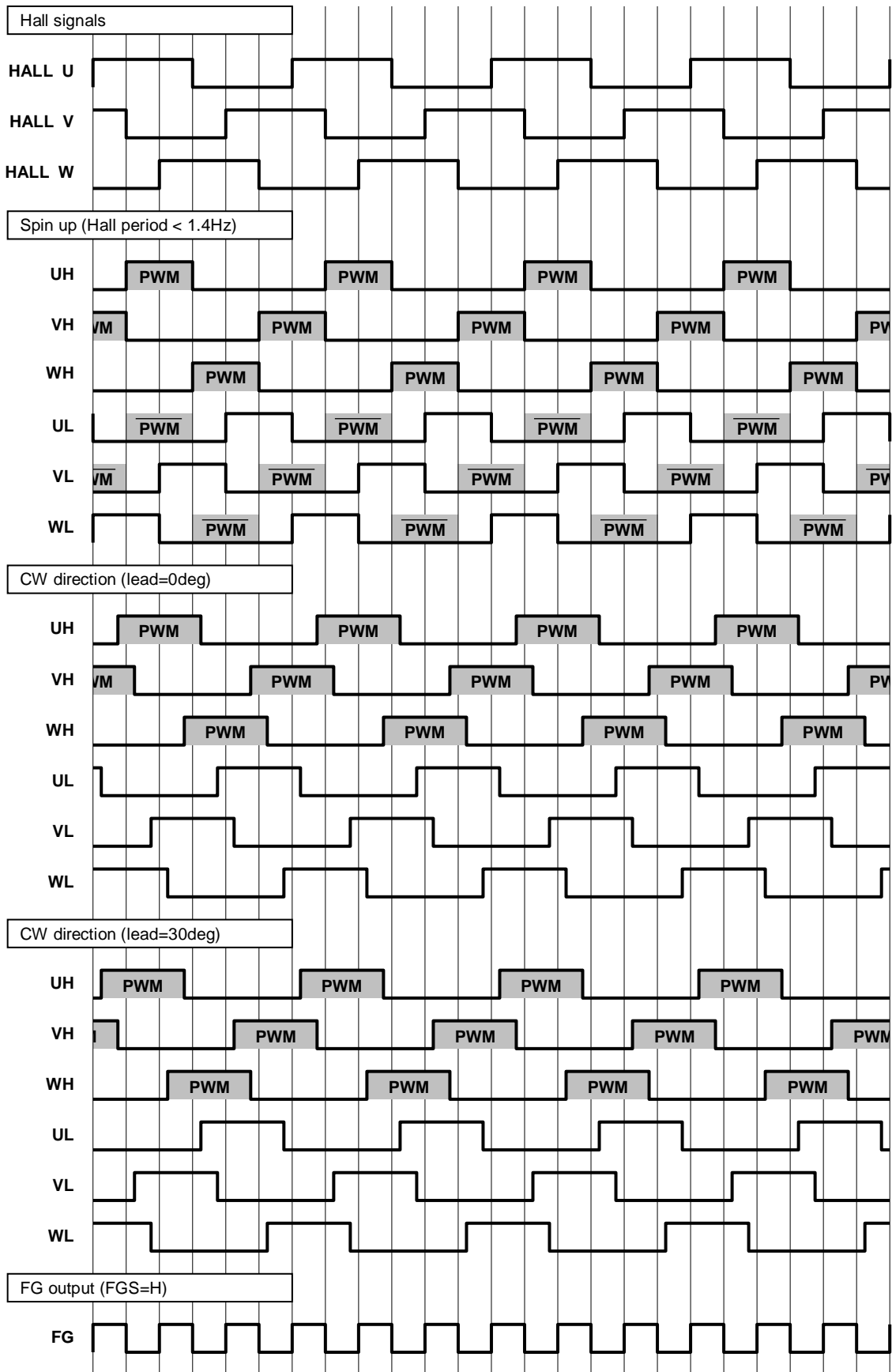

Figure 47. Timing Chart (Counter Clockwise, SQB=H)

Timing Chart (CW, SQB=L)

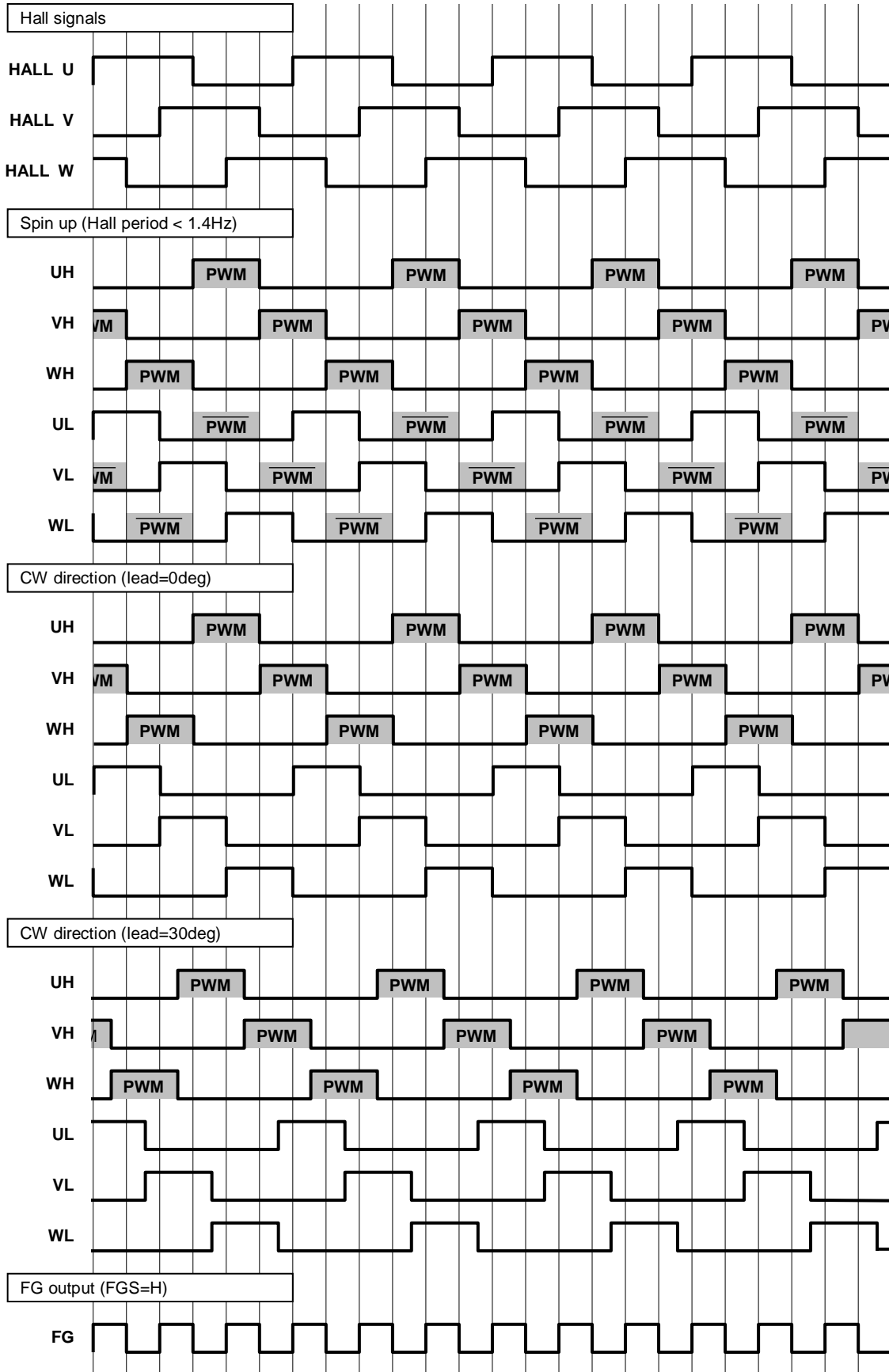

Figure 48. Timing Chart (Clockwise, SQB=L)

Timing Chart (CCW, SQB=L)

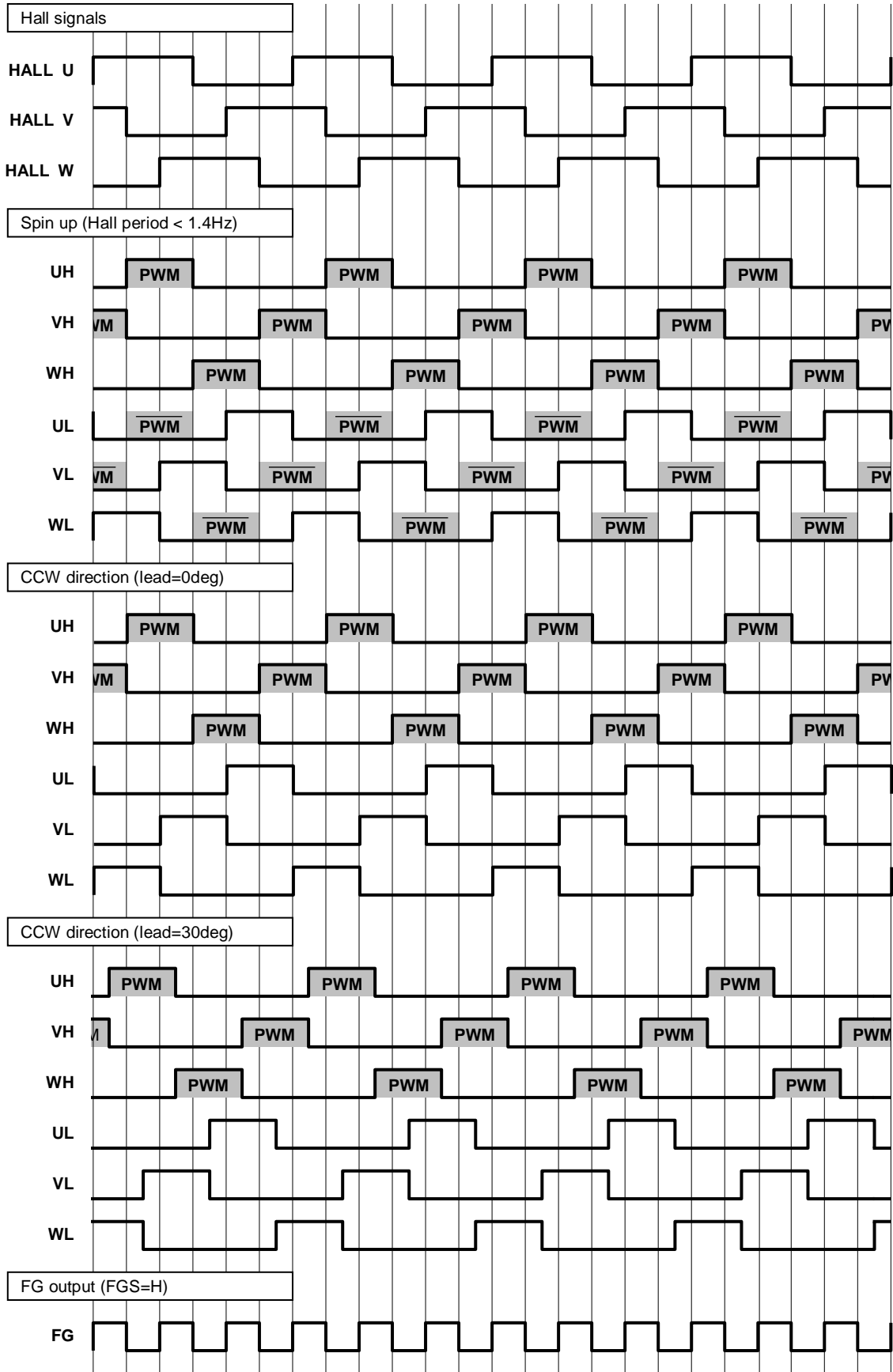

Figure 49. Timing Chart (Counter Clockwise, SQB=L)

Application Example

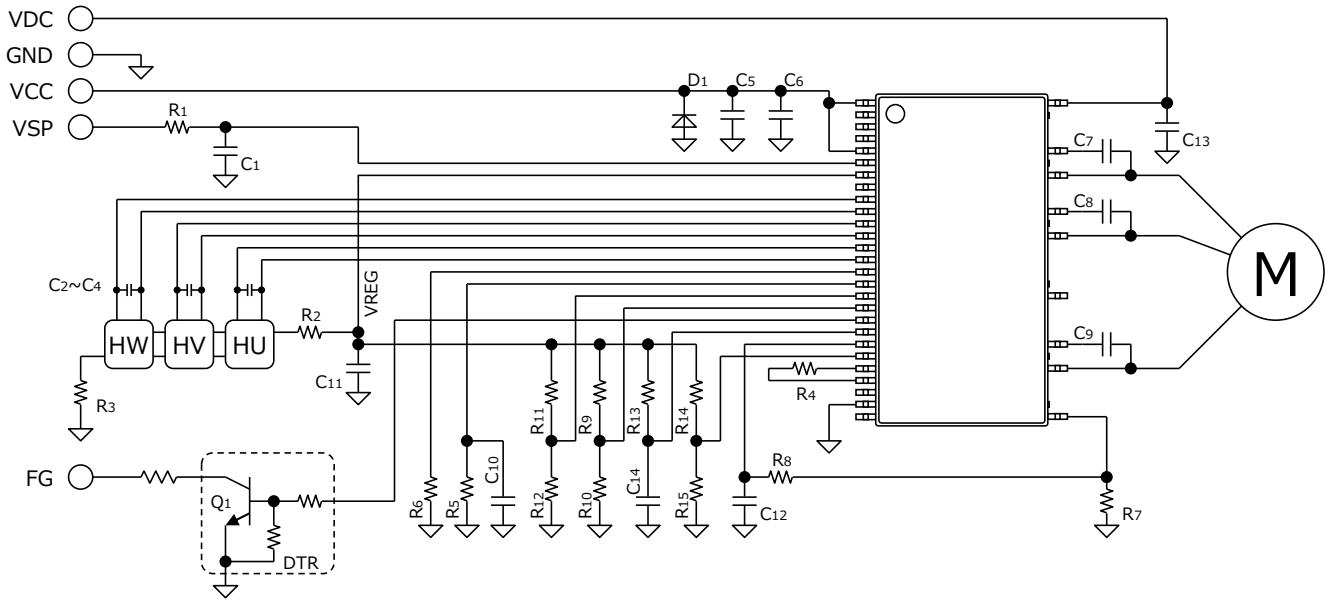

Figure 50. Application Example (150° Commutation Driver, CCW="H", FGS="H", SQB="H")

Parts List

Parts	Value	Manufacturer	Type	Parts	Value	Ratings	Type
IC ₁	-	ROHM	BM6244FS	C ₁	0.1μF	50V	Ceramic
R ₁	1kΩ	ROHM	MCR18EZPF1001	C ₂	220pF	50V	Ceramic
R ₂	150Ω	ROHM	MCR18EZPJ151	C ₃	220pF	50V	Ceramic
R ₃	150Ω	ROHM	MCR18EZPJ151	C ₄	220pF	50V	Ceramic
R ₄	20kΩ	ROHM	MCR18EZPF2002	C ₅	10 μF	50V	Ceramic
R ₅	51kΩ	ROHM	MCR18EZPF5102	C ₆	10 μF	50V	Ceramic
R ₆	100kΩ	ROHM	MCR18EZPF1003	C ₇	2.2μF	50V	Ceramic
R ₇	0.5Ω	ROHM	MCR50JZHFL1R50 // 3	C ₈	2.2μF	50V	Ceramic
R ₈	10kΩ	ROHM	MCR18EZPF1002	C ₉	2.2μF	50V	Ceramic
R ₉	0Ω	ROHM	MCR18EZPJ000	C ₁₀	0.1μF	50V	Ceramic
R ₁₀	-	-	-	C ₁₁	2.2uF	50V	Ceramic
R ₁₁	0Ω	ROHM	MCR18EZPJ000	C ₁₂	100pF	50V	Ceramic
R ₁₂	-	-	-	C ₁₃	0.1μF	250V	Ceramic
R ₁₃	100kΩ	ROHM	MCR18EZPF1003	C ₁₄	0.1μF	50V	Ceramic
R ₁₄	0Ω	ROHM	MCR18EZPJ000	HX	-	-	Hall elements
R ₁₅	-	-	-				
Q ₁	-	ROHM	DTC124EUA				
D ₁	-	ROHM	KDZ20B				

Dummy Pin Descriptions

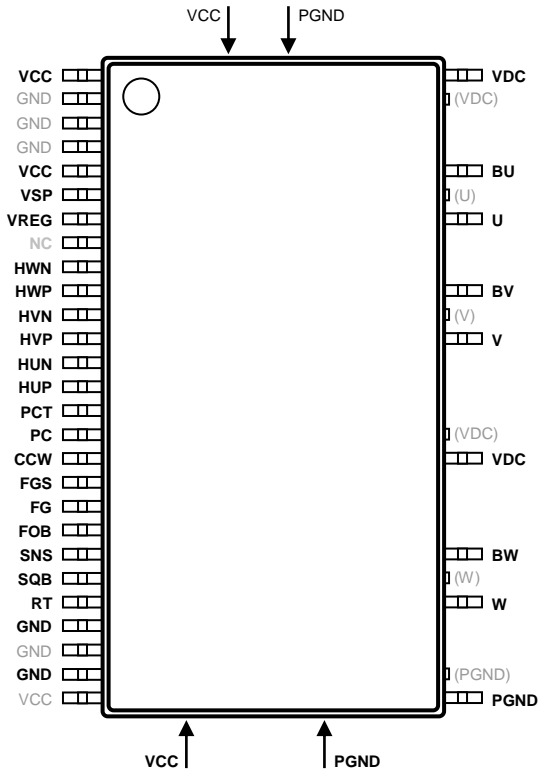

Figure 51. Dummy Pins

Dummy pins handling inside the package

- All VCC pins are electrically connected in the inner lead frame except 5pin.
- GND pins, 2pin, 3pin, 4pin, 24pin, 25pin and 26pin are electrically connected in the inner lead frame.
- VDC pins, 31pin and 36pin are electrically connected in the inner lead frame.

Plural same name pins

- 5pin is an independent VCC pin. 5pin and the other VCC pins are electrically not connected in the inner lead frame. Therefore, 5pin and 1pin needs to connect the pins each other.
- 24pin, 25pin and 26pin are electrically connected in the inner lead frame, but 24pin is better to use the carrier frequency setting ground pin, and 26pin is also better to use the small signal ground, separately. [Refer to the functional block diagram or an application circuit example.](#)

I/O Equivalent Circuits

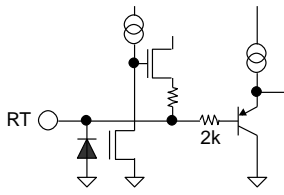

Figure 52. RT

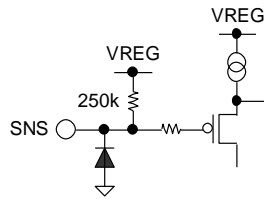

Figure 53. SNS

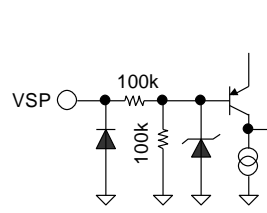

Figure 54. VSP

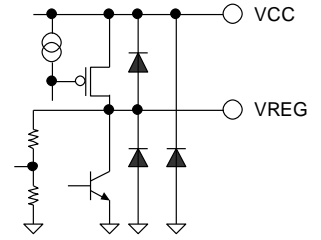

Figure 55. VREG, VCC

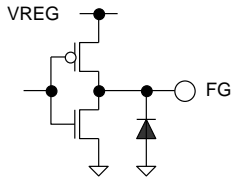

Figure 56. FG

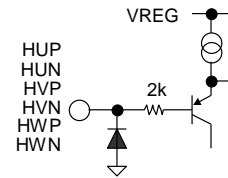

Figure 57. HXP, HXN

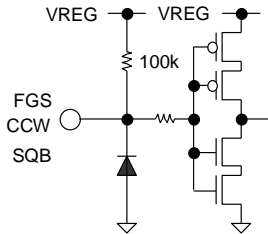

Figure 58. FGS, CCW, SQB

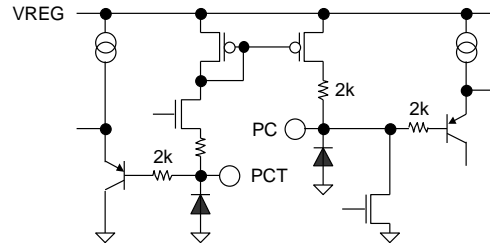

Figure 59. PC, PCT

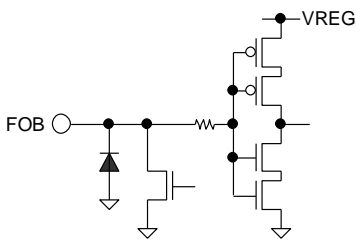

Figure 60. FOB

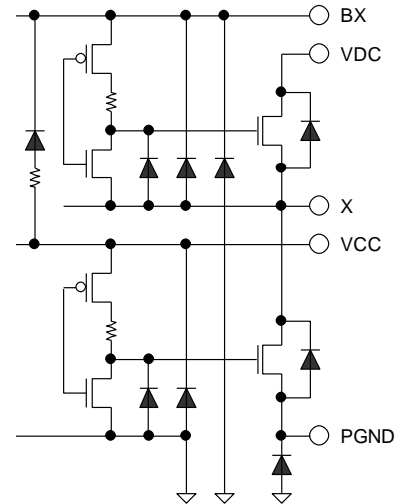

Figure 61. VCC, PGND, VDC, BX(BU/BV/BW), X(U/V/W)

Operational Notes

1. Reverse Connection of Power Supply

Connecting the power supply in reverse polarity can damage the IC. Take precautions against reverse polarity when connecting the power supply, such as mounting an external diode between the power supply and the IC's power supply pins.

2. Power Supply Lines

Design the PCB layout pattern to provide low impedance supply lines. Separate the ground and supply lines of the digital and analog blocks to prevent noise in the ground and supply lines of the digital block from affecting the analog block. Furthermore, connect a capacitor to ground at all power supply pins. Consider the effect of temperature and aging on the capacitance value when using electrolytic capacitors.

3. Ground Voltage

Ensure that no pins are at a voltage below that of the ground pin at any time, even during transient condition. However, pins that drive inductive loads (e.g. motor driver outputs, DC-DC converter outputs) may inevitably go below ground due to back EMF or electromotive force. In such cases, the user should make sure that such voltages going below ground will not cause the IC and the system to malfunction by examining carefully all relevant factors and conditions such as motor characteristics, supply voltage, operating frequency and PCB wiring to name a few.

4. Ground Wiring Pattern

When using both small-signal and large-current ground traces, the two ground traces should be routed separately but connected to a single ground at the reference point of the application board to avoid fluctuations in the small-signal ground caused by large currents. Also ensure that the ground traces of external components do not cause variations on the ground voltage. The ground lines must be as short and thick as possible to reduce line impedance.

5. Recommended Operating Conditions

The function and operation of the IC are guaranteed within the range specified by the recommended operating conditions. The characteristic values are guaranteed only under the conditions of each item specified by the electrical characteristics.

6. Inrush Current

When power is first supplied to the IC, it is possible that the internal logic may be unstable and inrush current may flow instantaneously due to the internal powering sequence and delays, especially if the IC has more than one power supply. Therefore, give special consideration to power coupling capacitance, power wiring, width of ground wiring, and routing of connections.

7. Operation Under Strong Electromagnetic Field

Operating the IC in the presence of a strong electromagnetic field may cause the IC to malfunction.

8. Testing on Application Boards

When testing the IC on an application board, connecting a capacitor directly to a low-impedance output pin may subject the IC to stress. Always discharge capacitors completely after each process or step. The IC's power supply should always be turned off completely before connecting or removing it from the test setup during the inspection process. To prevent damage from static discharge, ground the IC during assembly and use similar precautions during transport and storage.

9. Inter-pin Short and Mounting Errors

Ensure that the direction and position are correct when mounting the IC on the PCB. Incorrect mounting may result in damaging the IC. Avoid nearby pins being shorted to each other especially to ground, power supply and output pin. Inter-pin shorts could be due to many reasons such as metal particles, water droplets (in very humid environment) and unintentional solder bridge deposited in between pins during assembly to name a few.

10. Unused Input Pins

Input pins of an IC are often connected to the gate of a MOS transistor. The gate has extremely high impedance and extremely low capacitance. If left unconnected, the electric field from the outside can easily charge it. The small charge acquired in this way is enough to produce a significant effect on the conduction through the transistor and cause unexpected operation of the IC. So unless otherwise specified, unused input pins should be connected to the power supply or ground line.

11. Regarding the Input Pin of the IC

Do not force voltage to the input pins when the power does not supply to the IC. Also, do not force voltage to the input pins that exceed the supply voltage or in the guaranteed the absolute maximum rating value even if the power is supplied to the IC.

When using this IC, the high voltage pins VDC, BU/U, BV/V and BW/W need a resin coating between these pins. It is judged that the inter-pins distance is not enough. If any special mode in excess of absolute maximum ratings is to be implemented with this product or its application circuits, it is important to take physical safety measures, such as providing voltage-clamping diodes or fuses. And, set the output transistor so that it does not exceed absolute maximum ratings or ASO. In the event a large capacitor is connected between the output and ground, and if VCC and VDC are short-circuited with 0V or ground for any reason, the current charged in the capacitor flows into the output and may destroy the IC.

This IC contains the controller chip, P+ isolation and P substrate layers between adjacent elements in order to keep them isolated. P-N junctions are formed at the intersection of the P layers with the N layers of other elements, creating a parasitic diode or transistor. For example (refer to figure below):

When $GND > Pin A$ and $GND > Pin B$, the P-N junction operates as a parasitic diode.

When $GND > Pin B$, the P-N junction operates as a parasitic transistor.

Parasitic diodes inevitably occur in the structure of the IC. The operation of parasitic diodes can result in mutual interference among circuits, operational faults, or physical damage. Therefore, conditions that cause these diodes to operate, such as applying a voltage lower than the GND voltage to an input pin (and thus to the P substrate) should be avoided.

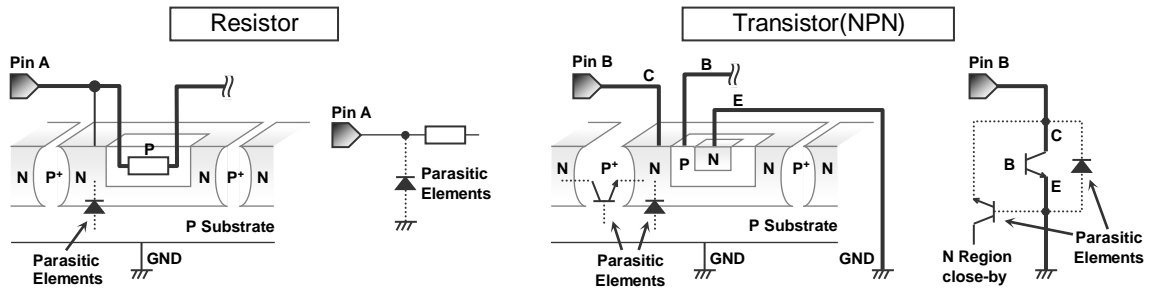

Figure 62. Example of IC structure

12. Ceramic Capacitor

When using a ceramic capacitor, determine a capacitance value considering the change of capacitance with temperature and the decrease in nominal capacitance due to DC bias and others.

13. Area of Safe Operation (ASO)

Operate the IC such that the output voltage, output current, and power dissipation are all within the Area of Safe Operation (ASO).

Ordering Information

B M 6 2 4 4 F S		-	Z E 2
ROHM Part Number BM6244 : 250V/2.0A, 150°/120°	Package FS : SSOP-A54_36A		Packaging specification E2 : Embossed carrier tape

Marking Diagrams

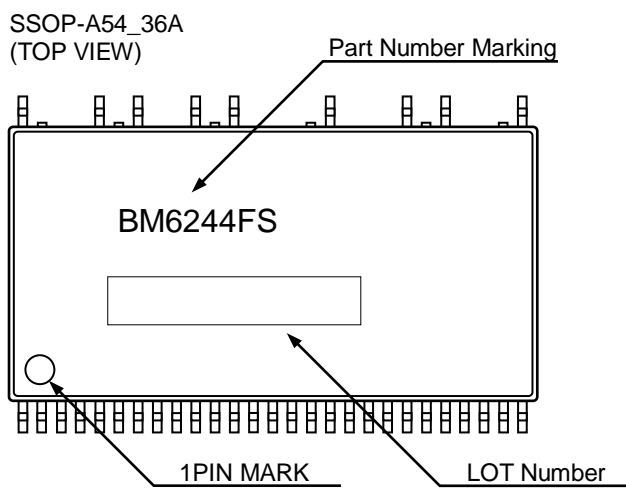

Physical Dimension and Packing Information

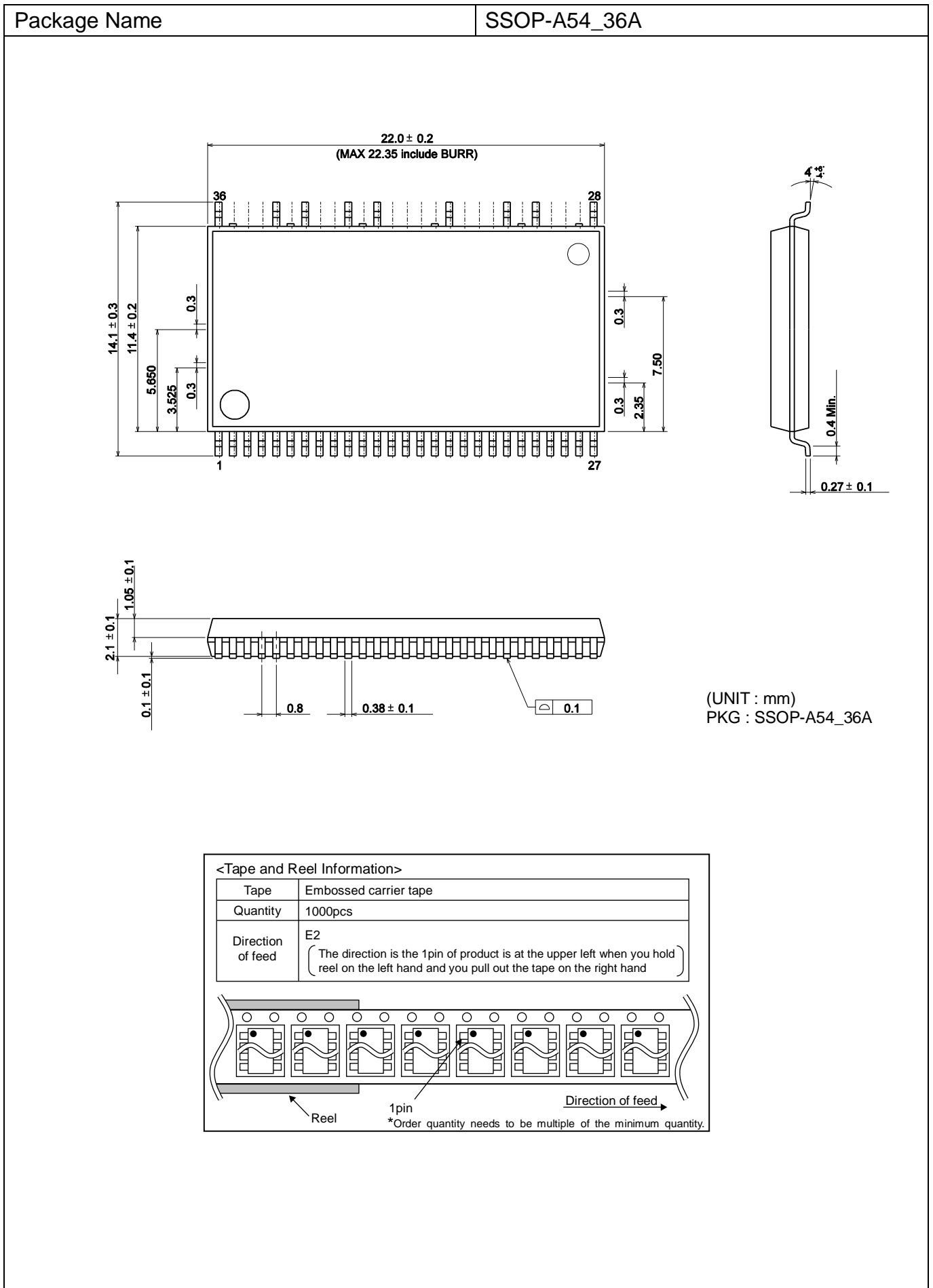

Revision History

Date	Revision	Changes
06.Apr.2018	001	New Release
22.Feb.2019	002	Correct some misdescriptions

Notice

Precaution on using ROHM Products

- Our Products are designed and manufactured for application in ordinary electronic equipment (such as AV equipment, OA equipment, telecommunication equipment, home electronic appliances, amusement equipment, etc.). If you intend to use our Products in devices requiring extremely high reliability (such as medical equipment ^(Note 1), transport equipment, traffic equipment, aircraft/spacecraft, nuclear power controllers, fuel controllers, car equipment including car accessories, safety devices, etc.) and whose malfunction or failure may cause loss of human life, bodily injury or serious damage to property ("Specific Applications"), please consult with the ROHM sales representative in advance. Unless otherwise agreed in writing by ROHM in advance, ROHM shall not be in any way responsible or liable for any damages, expenses or losses incurred by you or third parties arising from the use of any ROHM's Products for Specific Applications.

(Note1) Medical Equipment Classification of the Specific Applications

JAPAN	USA	EU	CHINA
CLASS III	CLASS III	CLASS II b	CLASS III
CLASS IV		CLASS III	

- ROHM designs and manufactures its Products subject to strict quality control system. However, semiconductor products can fail or malfunction at a certain rate. Please be sure to implement, at your own responsibilities, adequate safety measures including but not limited to fail-safe design against the physical injury, damage to any property, which a failure or malfunction of our Products may cause. The following are examples of safety measures:
 - Installation of protection circuits or other protective devices to improve system safety
 - Installation of redundant circuits to reduce the impact of single or multiple circuit failure
- Our Products are designed and manufactured for use under standard conditions and not under any special or extraordinary environments or conditions, as exemplified below. Accordingly, ROHM shall not be in any way responsible or liable for any damages, expenses or losses arising from the use of any ROHM's Products under any special or extraordinary environments or conditions. If you intend to use our Products under any special or extraordinary environments or conditions (as exemplified below), your independent verification and confirmation of product performance, reliability, etc. prior to use, must be necessary:
 - Use of our Products in any types of liquid, including water, oils, chemicals, and organic solvents
 - Use of our Products outdoors or in places where the Products are exposed to direct sunlight or dust
 - Use of our Products in places where the Products are exposed to sea wind or corrosive gases, including Cl₂, H₂S, NH₃, SO₂, and NO₂
 - Use of our Products in places where the Products are exposed to static electricity or electromagnetic waves
 - Use of our Products in proximity to heat-producing components, plastic cords, or other flammable items
 - Sealing or coating our Products with resin or other coating materials
 - Use of our Products without cleaning residue of flux (Exclude cases where no-clean type fluxes is used. However, recommend sufficiently about the residue.) ; or Washing our Products by using water or water-soluble cleaning agents for cleaning residue after soldering
 - Use of the Products in places subject to dew condensation
- The Products are not subject to radiation-proof design.
- Please verify and confirm characteristics of the final or mounted products in using the Products.
- In particular, if a transient load (a large amount of load applied in a short period of time, such as pulse, is applied, confirmation of performance characteristics after on-board mounting is strongly recommended. Avoid applying power exceeding normal rated power; exceeding the power rating under steady-state loading condition may negatively affect product performance and reliability.
- De-rate Power Dissipation depending on ambient temperature. When used in sealed area, confirm that it is the use in the range that does not exceed the maximum junction temperature.
- Confirm that operation temperature is within the specified range described in the product specification.
- ROHM shall not be in any way responsible or liable for failure induced under deviant condition from what is defined in this document.

Precaution for Mounting / Circuit board design

- When a highly active halogenous (chlorine, bromine, etc.) flux is used, the residue of flux may negatively affect product performance and reliability.
- In principle, the reflow soldering method must be used on a surface-mount products, the flow soldering method must be used on a through hole mount products. If the flow soldering method is preferred on a surface-mount products, please consult with the ROHM representative in advance.

For details, please refer to ROHM Mounting specification

Precautions Regarding Application Examples and External Circuits

1. If change is made to the constant of an external circuit, please allow a sufficient margin considering variations of the characteristics of the Products and external components, including transient characteristics, as well as static characteristics.
2. You agree that application notes, reference designs, and associated data and information contained in this document are presented only as guidance for Products use. Therefore, in case you use such information, you are solely responsible for it and you must exercise your own independent verification and judgment in the use of such information contained in this document. ROHM shall not be in any way responsible or liable for any damages, expenses or losses incurred by you or third parties arising from the use of such information.

Precaution for Electrostatic

This Product is electrostatic sensitive product, which may be damaged due to electrostatic discharge. Please take proper caution in your manufacturing process and storage so that voltage exceeding the Products maximum rating will not be applied to Products. Please take special care under dry condition (e.g. Grounding of human body / equipment / solder iron, isolation from charged objects, setting of Ionizer, friction prevention and temperature / humidity control).

Precaution for Storage / Transportation

1. Product performance and soldered connections may deteriorate if the Products are stored in the places where:
 - [a] the Products are exposed to sea winds or corrosive gases, including Cl₂, H₂S, NH₃, SO₂, and NO₂
 - [b] the temperature or humidity exceeds those recommended by ROHM
 - [c] the Products are exposed to direct sunshine or condensation
 - [d] the Products are exposed to high Electrostatic
2. Even under ROHM recommended storage condition, solderability of products out of recommended storage time period may be degraded. It is strongly recommended to confirm solderability before using Products of which storage time is exceeding the recommended storage time period.
3. Store / transport cartons in the correct direction, which is indicated on a carton with a symbol. Otherwise bent leads may occur due to excessive stress applied when dropping of a carton.
4. Use Products within the specified time after opening a humidity barrier bag. Baking is required before using Products of which storage time is exceeding the recommended storage time period.

Precaution for Product Label

A two-dimensional barcode printed on ROHM Products label is for ROHM's internal use only.

Precaution for Disposition

When disposing Products please dispose them properly using an authorized industry waste company.

Precaution for Foreign Exchange and Foreign Trade act

Since concerned goods might be fallen under listed items of export control prescribed by Foreign exchange and Foreign trade act, please consult with ROHM in case of export.

Precaution Regarding Intellectual Property Rights

1. All information and data including but not limited to application example contained in this document is for reference only. ROHM does not warrant that foregoing information or data will not infringe any intellectual property rights or any other rights of any third party regarding such information or data.
2. ROHM shall not have any obligations where the claims, actions or demands arising from the combination of the Products with other articles such as components, circuits, systems or external equipment (including software).
3. No license, expressly or implied, is granted hereby under any intellectual property rights or other rights of ROHM or any third parties with respect to the Products or the information contained in this document. Provided, however, that ROHM will not assert its intellectual property rights or other rights against you or your customers to the extent necessary to manufacture or sell products containing the Products, subject to the terms and conditions herein.

Other Precaution

1. This document may not be reprinted or reproduced, in whole or in part, without prior written consent of ROHM.
2. The Products may not be disassembled, converted, modified, reproduced or otherwise changed without prior written consent of ROHM.
3. In no event shall you use in any way whatsoever the Products and the related technical information contained in the Products or this document for any military purposes, including but not limited to, the development of mass-destruction weapons.
4. The proper names of companies or products described in this document are trademarks or registered trademarks of ROHM, its affiliated companies or third parties.

General Precaution

1. Before you use our Products, you are requested to carefully read this document and fully understand its contents. ROHM shall not be in any way responsible or liable for failure, malfunction or accident arising from the use of any ROHM's Products against warning, caution or note contained in this document.
2. All information contained in this document is current as of the issuing date and subject to change without any prior notice. Before purchasing or using ROHM's Products, please confirm the latest information with a ROHM sales representative.
3. The information contained in this document is provided on an "as is" basis and ROHM does not warrant that all information contained in this document is accurate and/or error-free. ROHM shall not be in any way responsible or liable for any damages, expenses or losses incurred by you or third parties resulting from inaccuracy or errors of or concerning such information.