



# PRODUCT SELECTOR GUIDE

December 2023

# The Lattice Advantage



## CONTENTS

---

|  |       |
|--|-------|
| ■ Solution Stacks .....                      | 4-11  |
| ■ FPGA Products .....                        | 12-14 |
| ■ Video Connectivity .....                   | 15-16 |
| ■ Control & Security .....                   | 17-19 |
| ■ Ultra Low Power.....                       | 20    |
| ■ Power and Thermal Management Products..... | 21    |
| ■ IP Cores and Reference Designs.....        | 22-26 |
| ■ Development Kits .....                     | 27-38 |
| ■ Programming Hardware.....                  | 39    |
| ■ FPGA and CPLD Design Software .....        | 40    |

## Lattice sensAI™ Solution Stack

### Accelerate Integration of Flexible, Ultra Low Power Inferencing

With solutions optimized for ultra low power consumption (under 1 mW – 1 W), small package size (5.5 mm<sup>2</sup> – 100 mm<sup>2</sup>), customizable performance and accuracy, and interface flexibility (MIPI CSI-2, LVDS, GigE, etc.), the Lattice sensAI stack accelerates integration of scalable, always-on, on-device AI.

## Lattice mVision™ Solution Stack

### Accelerate Implementation of Low Power Embedded Vision Applications

With solutions optimized for low power consumption ranging from under 150 mW to 1 W and small package size (2.5 x 2.5 mm to 10 x 10 mm) the Lattice mVision solution stack provides customizable performance and flexible interface connectivity (MIPI CSI-2, LVDS, PCIe, GigE, etc.). Lattice's mVision solution stack accelerates the integration of scalable Embedded Vision solutions for Smart Factory, Machine Vision, Smart City, and Smart Home applications.

## Lattice Sentry™ Solution Stack

### Software Solution for Platform Firmware Resiliency (PFR) Root of Trust

The Lattice Sentry solution stack consists of a complete reference platform, fully validated IP building blocks, easy to use FPGA design tools, reference design/demonstrations, as well as a network of custom design services. In many instances, a fully functioning PFR solution can be developed by modifying the included RISC-V C source code.

## Lattice Automate™ Solution Stack

Lattice Automate helps designers accelerate high performance, low power, secure solutions for next generation factory automation solutions. The stack includes modular hardware development boards and software-programmable reference designs and demos that simplify and accelerate implementation of applications like robotics, scalable multi-channel motor control with predictive maintenance, and real-time industrial networking.

## Lattice SupplyGuard™

### End-to-End Supply Chain Protection Service

The Lattice SupplyGuard™ service provides customers with factory-locked ICs. These ICs can only be programmed using a configuration bitstream which has been developed, signed and encrypted by the intended customer. The solution is designed to provide protection against counterfeiting, over-building, malware insertion and IP theft.

## General Purpose FPGAs

### Low Power FPGAs (CertusPro-NX, Certus-NX, ECP, and LatticeXP2 families)

Addresses a broad range of connectivity and acceleration applications across multiple markets.

- Lowest power and smallest package with up to 10G SERDES and 100K LCs
- Industry-leading reliability and efficient processing (with class-leading on-chip memory and LPDDR4 support)

## Specialized Families Tailored For Specific Needs

### Video Connectivity FPGAs (CrossLink Families)

Optimized for high speed video and sensor applications

- First FPGA with hardened MIPI D-PHY
- Highest performance at lowest power

### Ultra Low Power FPGAs (iCE40 Families)

World's lowest power FPGAs; Optimized for small form factor

- Static current as low as 25 uA
- World's most popular ultra low power FPGA

### Control & Security FPGAs (Mach & L-ASC10 Families)

Optimized for platform management & security applications

- Instant-on, non-volatile
- Highest I/O density

# Ultra Low Power Lattice sensAI™ Stack

## Delivering Milliwatt AI to the Edge with Flexible FPGAs

With solutions optimized for ultra low power consumption (under 1 mW – 1 W), small package size (5.5 mm<sup>2</sup>– 100 mm<sup>2</sup>), customizable performance and accuracy, and interface flexibility (MIPI CSI-2, LVDS, GigE, etc.), the Lattice sensAI stack accelerates integration of scalable, always-on, on-device AI.



Complete technology stack for ultra low power flexible inferencing

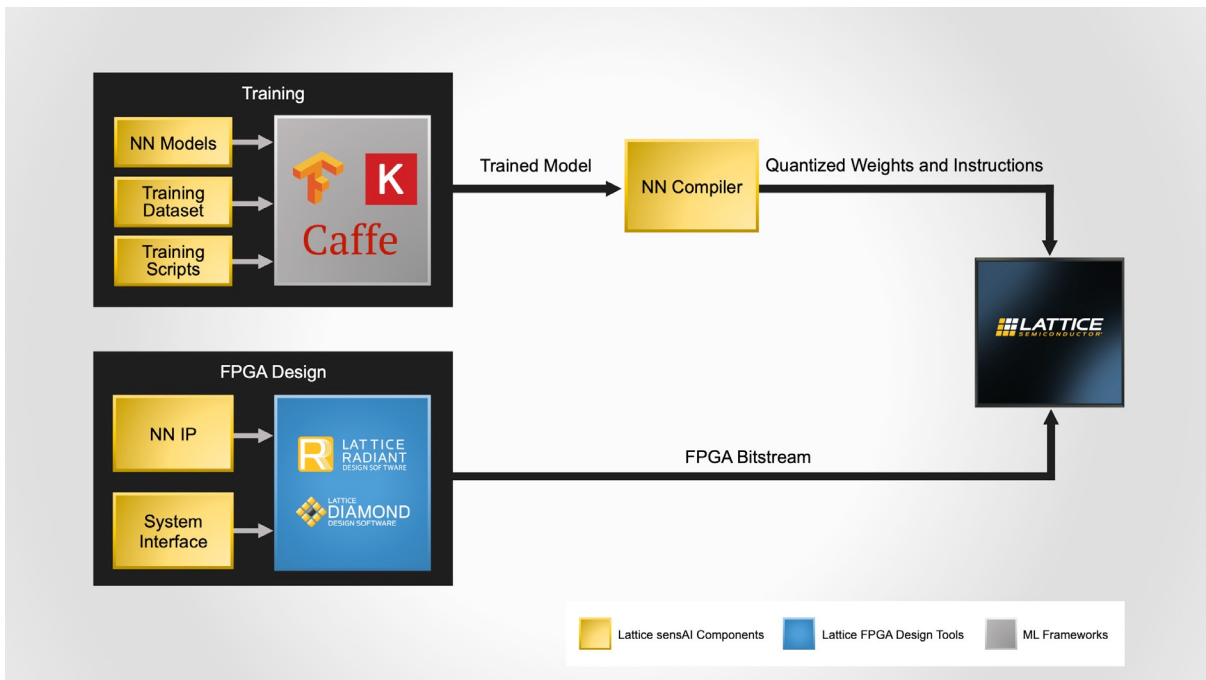

Rapid design space exploration - Performance vs Power vs Accuracy tradeoffs

# Solution Stack – Lattice sensAI

## Lattice sensAI Hardware Platforms



### ■ CrossLink-NX VIP Sensor Input Board

- Key Features:
  - Seamless connectivity to the Embedded Vision Development Kit
  - Optimized for fast prototyping vision-based AI acceleration



### ■ Embedded Vision Development Kit

- Key Features:
  - ECP5™ FPGA consuming under 1 W of power consumption
  - Supports MIPI CSI-2, eDP, HDMI®, GigE Vision, USB 3.0, etc.



### ■ HM01B0 UPduino Shield

- Key Features:
  - A complete development kit for implementing AI using vision and sound as sensory inputs
  - iCE40 UltraPlus FPGA based Upduino 2.0 board and HiMax image sensor module

## Lattice sensAI IP Cores

| IP Core                 | OPN                  | Key Features  |
|-------------------------|----------------------|---|
| CNN Compact Accelerator | CNN-CPACCEL-UP-U     | Optimized for iCE40 UltraPlus FPGA, supports variable quantization          |
| CNN Accelerator         | CNN-ACCEL-E5-U       | Optimized for ECP5 FPGA, supports variable quantization                     |
| CNN Plus Accelerator    | CNNPLUS-ACCEL-CN-X-U | For use with CrossLink-NX FPGA, supports compact and high performance modes |

## Lattice sensAI Software Tools

| Software Tool           | Key Features  |
|-------------------------|---|
| Neural Network Compiler | Supports TensorFlow, Keras and Caffe. No prior RTL experience required. |

## Lattice sensAI Reference Designs

| Reference Design/Demo     | Supported FPGA, HW Platform                                  | Power Consumption |
|---------------------------|--|-------------------|
| Human Face Identification | ECP5, Embedded Vision Development Kit                        | < 1 W             |
| Object Counting           | ECP5, Embedded Vision Development Kit                        | < 1 W             |
| Object Counting           | CrossLink-NX, CrossLink-NX VIP Sensor Input Board            | 200 mW            |
| Human Presence Detection  | iCE40 UltraPlus/HiMax HM01B0 UPduino Shield                  | < 8 mW            |
| Key Phrase Detection      | iCE40 UltraPlus, iCE40 UltraPlus Mobile Development Platform | < 8 mW            |

## Lattice sensAI Stack Custom Design Services

Have custom AI solution needs? The senseAI stack includes an ecosystem of select, global design service partners that can deliver custom solutions for a range of end applications, including Smart Home, Smart City, Smart Factory, and Smart Cars. Please contact your local sales representative to request more information.

For more information go to [LATTICESEMI.COM/SENSAI](https://LATTICESEMI.COM/SENSAI)

# Lattice mVision™ Solution Stack

## Accelerate Implementation of Low Power Embedded Vision Applications

With solutions optimized for low power consumption ranging from under 150 mW to 1 W and small package size (2.5 x 2.5 mm to 10 x 10 mm) Lattice mVision solution stack provides customizable performance and flexible interface connectivity (MIPI CSI-2, LVDS, PCIe, GigE, etc.). Lattice's mVision solution stack accelerates the integration of scalable Embedded Vision solutions for Smart Factory, Machine Vision, Smart City, and Smart Home applications.

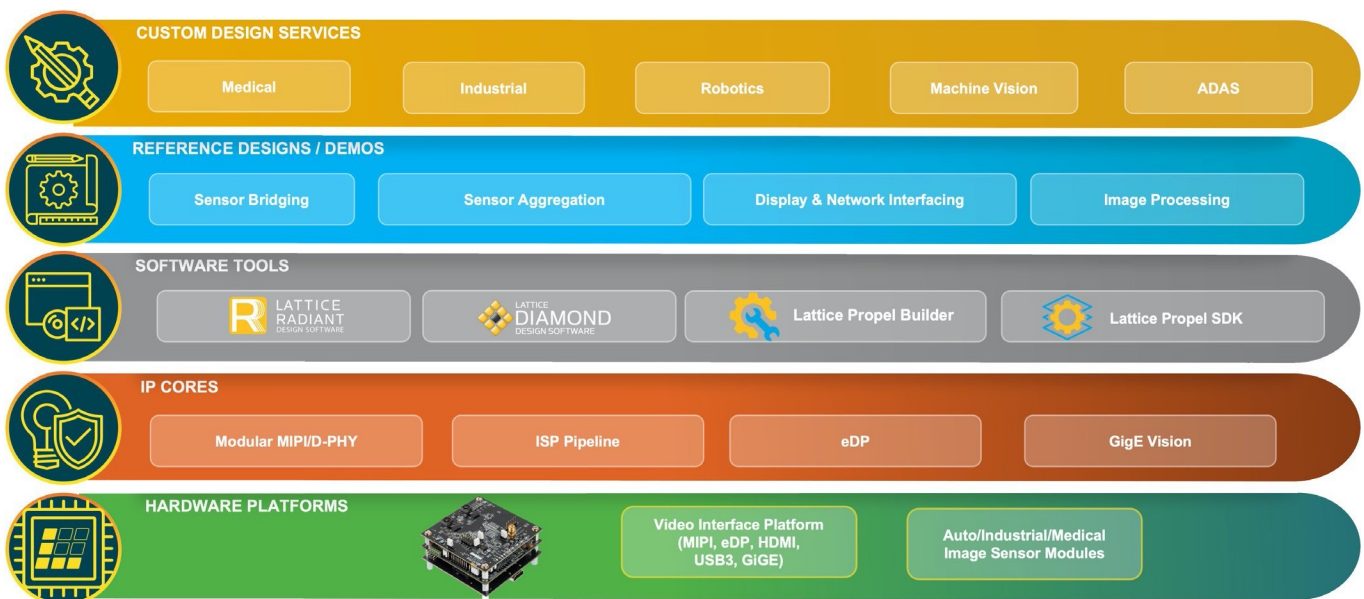

## Lattice mVision Hardware Platforms

The Lattice mVision solution stack uses the award-winning Video Interface Platform (VIP) ([www.latticesemi.com/vip](http://www.latticesemi.com/vip)) which is the ideal hardware for Embedded Vision designs and it provides a highly flexible, smart modular solution for Embedded Vision designers who need to build a prototyping system quickly.

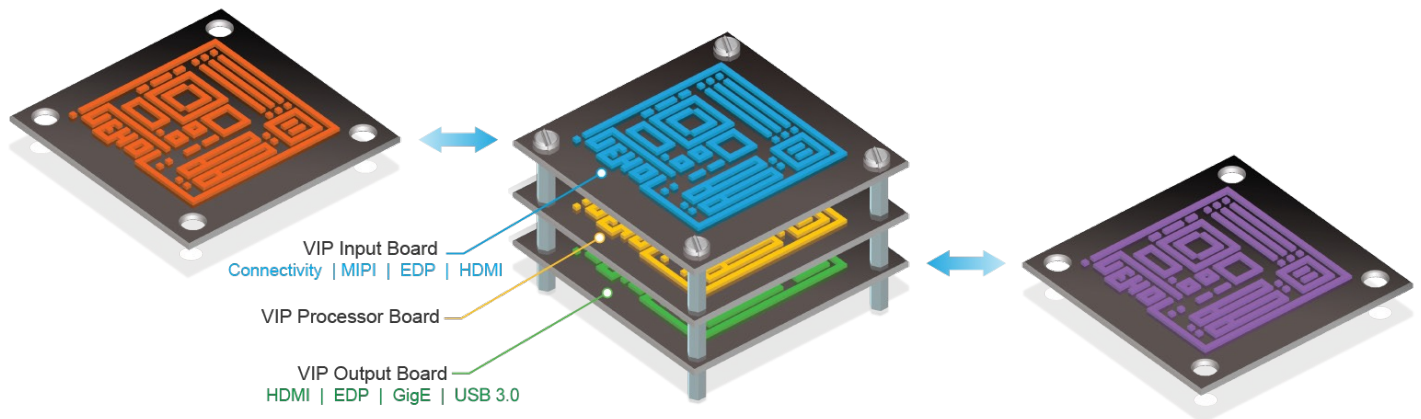

# Solution Stack – Lattice mVision

## Lattice mVision IP Cores

|                               |                       |
|-------------------------------|-----------------------|
| CSI-2/DSI D-PHY Receiver      | FPD-LINK Receiver     |
| CSI-2/DSI D-PHY Transmitter   | FPD-LINK Transmitter  |
| Byte to Pixel Converter       | Color Space Converter |
| Pixel to Byte Converter       | Video Frame Buffer    |
| SubLVDS Image Sensor Receiver | Gamma Corrector       |
|                               | 2D Scaler             |

## Lattice mVision Partner IP

|  |
|--|
| Helion IONOS Image Signal Processing (ISP) |
| Bitec DisplayPort IP                       |
| Helion GigE Vision IP                      |

## Lattice mVision Design Tools

Lattice's mVision solution stack uses Lattice's standard Radiant and Diamond FPGA design tools for ease of use and fast system design.



## Lattice mVision Reference Designs

|   |
|---|
| N Input to 1 Output MIPI CSI-2 Camera Aggregator Bridge |
| 4 to 1 Image Aggregation with CrossLink-NX              |
| SubLVDS to MIPI CSI-2 Image Sensor Bridge 4 to 1 Image  |
| MIPI DSI/CSI-2 to OpenLDI LVDS Interface Bridge         |

## Lattice mVision Demonstrations

|  |                           |
|--|---------------------------|
| 4 to 1 Image Aggregation Demo for CrossLink-NX Image Input Board | DisplayPort Transmit Demo |
| 2 to 1 side by side Demo for CrossLink on EVDK                   | Helion GigE Vision        |
| 3D Depth-Mapping   | IONOS ISP from Helion     |
| Video over USB 3.0   | DisplayPort Receive Demo  |
| Video over Ethernet  |                           |

## Lattice mVision Custom Design Services

Have custom Embedded Vision solutions needs? The Lattice mVision stack includes an ecosystem of select, global design service partners that can deliver custom solutions for a range of end applications, including Factory, Smart Home, Smart City, and Smart Cars. Please contact your local sales representative to request more information.

For more information go to [LATTICESEMI.COM/MVISION](http://LATTICESEMI.COM/MVISION)

## Solution Stack – Lattice Sentry

# Lattice Sentry™ Solution Stack

Dynamic PFR Solution for Comprehensive Coverage of NIST 800-193 Guidelines

Complete and Easily Configurable PFR RoT Solution 

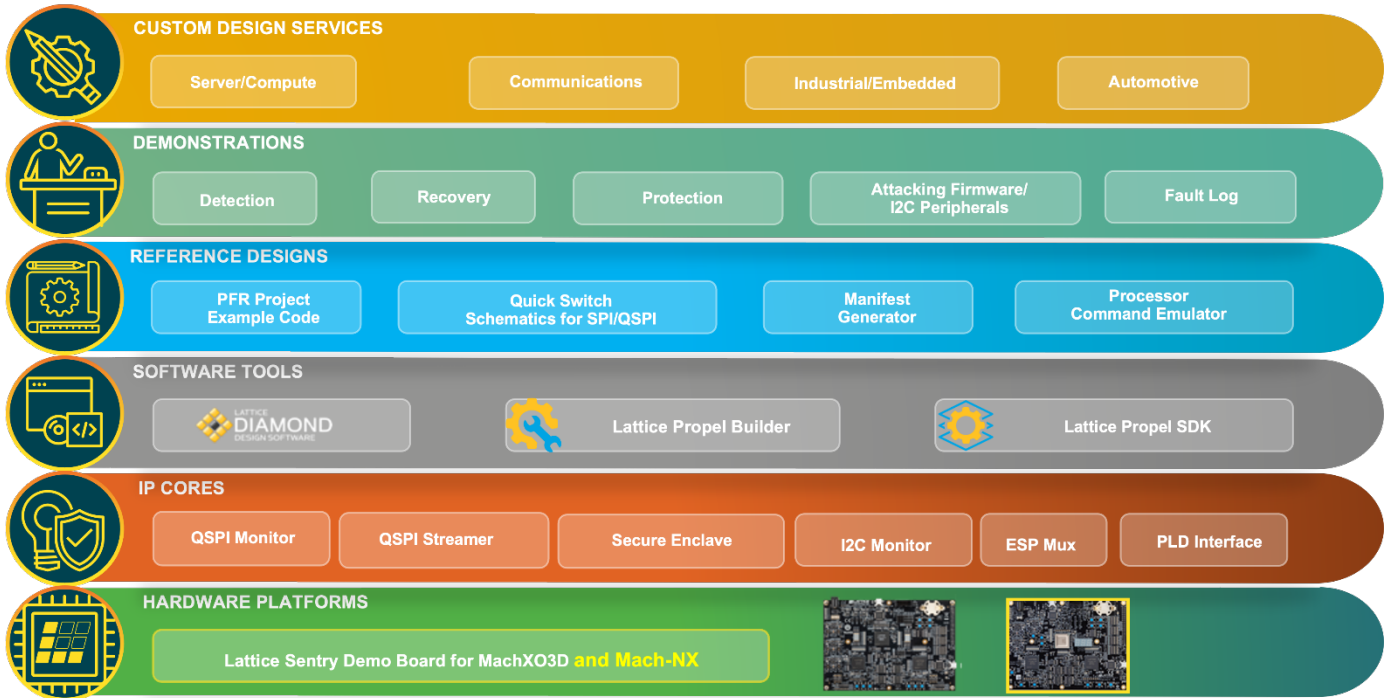

Complete solution toolkit includes everything needed to create a custom Platform Firmware Resiliency (PFR) Implementation

Solution allows secure protection of firmware before, during, and after system boot.

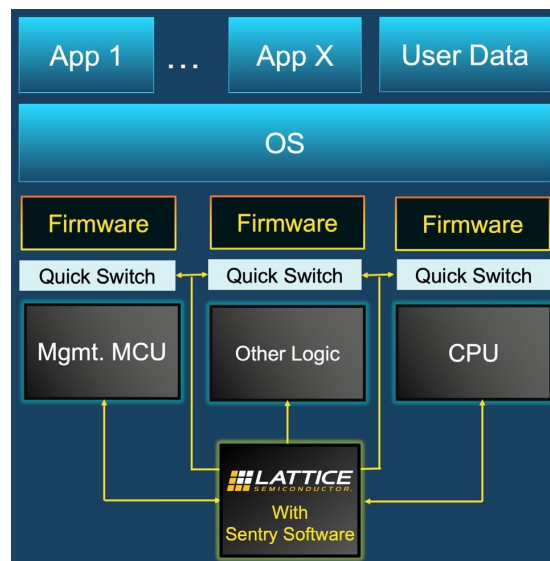



# Solution Stack – Lattice Sentry

## Proven Lattice Sentry IP Cores

- QSPI Streamer
- QSPI Monitor
- I<sup>2</sup>C Monitor
- PLD Interface
- Embedded Security Block Mux
- RISC-V CPU

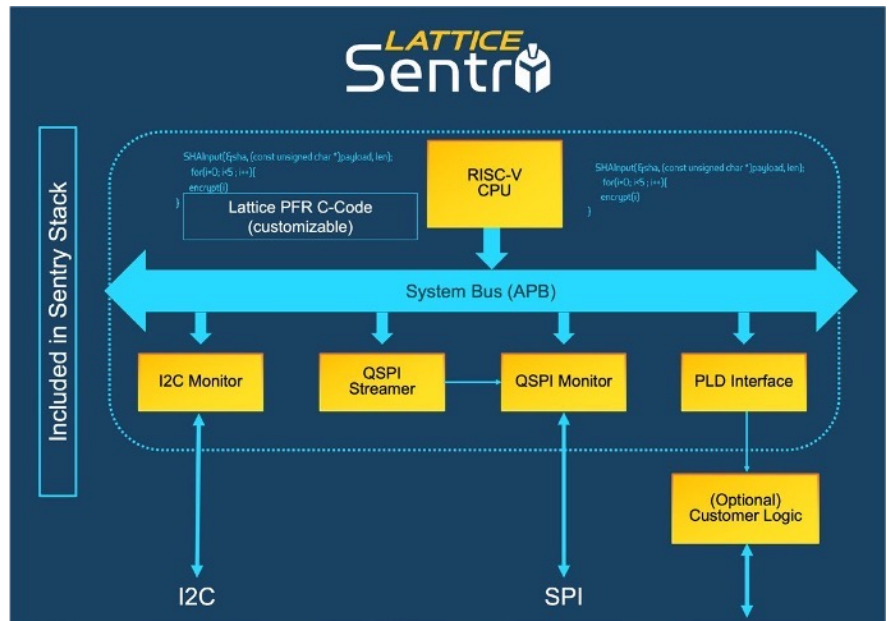

## Easy To Use Lattice Design Tools



## Plug & Play Lattice Sentry Reference Designs

- PFR Project Example Code
- QuickSwitch Schematics for SPI/QSPI
- Manifest Generator
- Processor Command Emulator

## Instructive Lattice Sentry Demonstrations

- Protection
- Detection
- Recovery
- Attacking Firmware/I<sup>2</sup>C Peripherals
- Fault Log
- Implemented on Lattice Sentry Demo Board for MachXO3D

## Lattice Sentry Custom Design Services

Have customized PFR needs for your design or market? The Lattice Sentry solution is fully customizable, and Lattice has a global Application Services staff who can perform custom IP development if needed. These customizations can enable a resilient PFR solution across a wide range of end applications, including Communications, Industrial, Client Computing, Automotive and Datacenter. Please contact your local Lattice sales agent to request more information.

For more information go to [LATTICESEMI.COM/SENTRY](https://LATTICESEMI.COM/SENTRY)

## Lattice Automate™ Solution Stack

### Accelerating Factory Automation

Lattice Automate™ helps designers accelerate high performance, low power, secure solutions for next generation factory automation solutions. The stack includes modular hardware development boards and software- programmable reference designs and demos that simplify and accelerate implementation of applications like robotics, scalable multi-channel motor control with predictive maintenance, and real-time industrial networking.

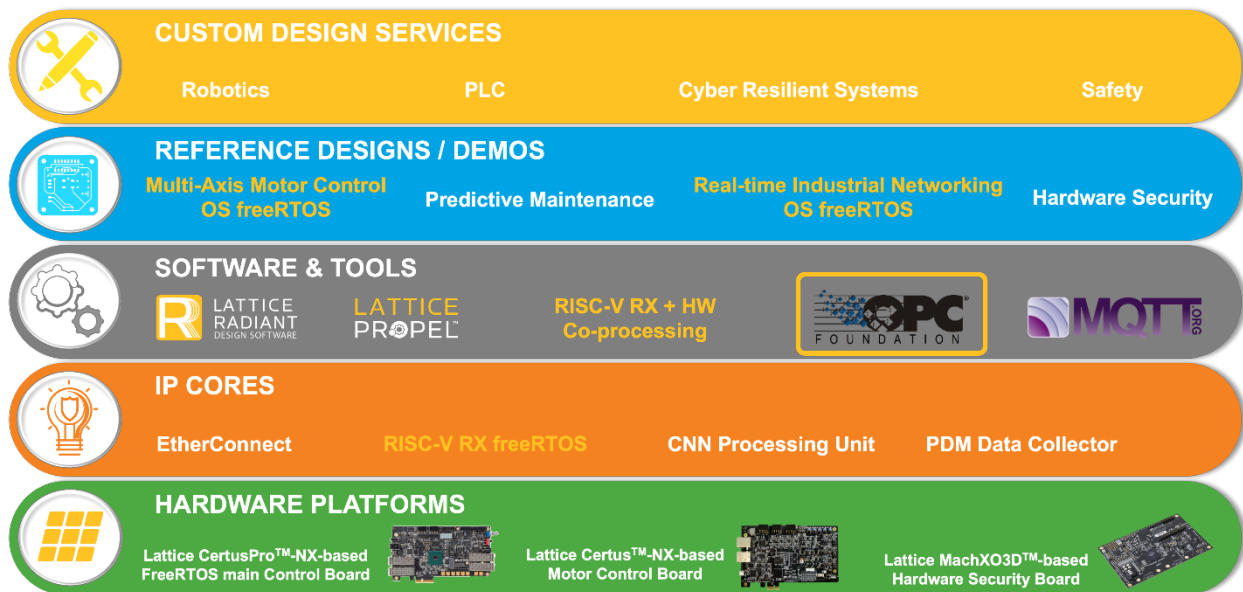

● New in Automate 3.0

### Hardware Platform

The Lattice Automate solution stack runs on the Certus-NX Versa development board which supports the main processing subsystem, connections to the Host PC, and also the embedded real time Ethernet links. The Motor Control nodes also utilize the Versa board.

### IP Cores

- EtherConnect – Enables compact, low power, modular real-time sense and control over embedded Ethernet connections
- CNN Processing Unit – Provides AI accelerator for Predictive Maintenance processing
- PDM Data Collector – Collects data from the Motor Control Nodes for input to the CNN Processing Unit

### Design Tools

Lattice’s Automate solution stack uses Lattice’s standard Radiant and Diamond FPGA design tools and Lattice Propel™, enabling RISC-V based SW and HW co-processing for ease of use and fast system design.



# Solution Stack – Lattice Automate

## Reference Designs & Demos

Multi-Channel Motor Control with Predictive Maintenance and Embedded Real Time Networking.

- Multi-Channel BLDC Motor Control
- Embedded Real-Time Networking
- AI enabled support for Predictive Maintenance
- GUI for controlling and monitoring the design

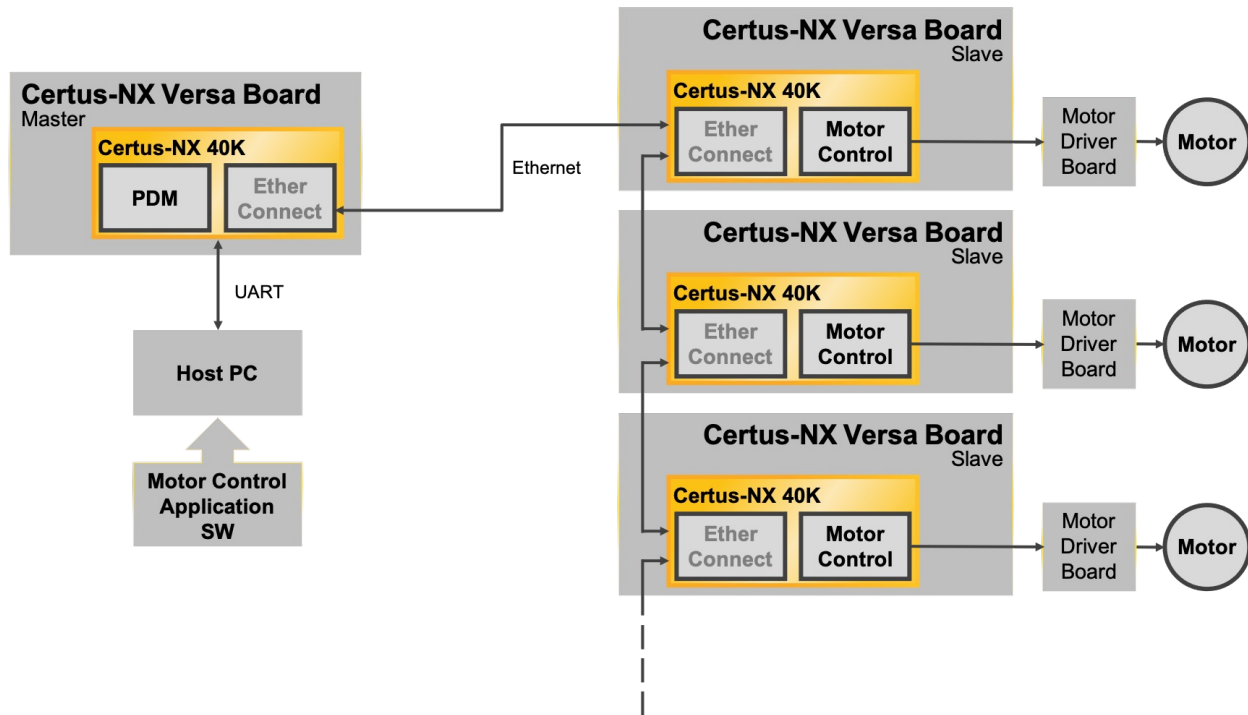

## Demo Hardware

- Certus-NX Versa. Platform with 5G PCIe, SGMII, DDR3 Memory and 40k Logic Cells. Main Controller and Nodes use the Certus-NX Versa board.
- Trenz Pmod compatible motor driver board, 15A 0-30V.
- Anaheim Automation BLY17 Series Brushless DC Motor.
- HW RoT Reference Design for Cyber Resiliency using MachXO3D
  - Demonstrate and test the ability to authenticate firmware of protected devices before boot
  - Detect and block illegal SPI and Flash operations
  - Automatically replace compromised firmware in the protected subsystem

## Lattice Automate Custom Design Services

Need help putting together solutions for Factory Automation? The Lattice Automate stack includes an ecosystem of select, global design service partners that can deliver custom solutions for a range of end-applications, including factory, smart home, smart city, and smart cars. Please contact your local sales representative to request more information.

For more information go to [LATTICESEMI.COM/AUTOMATE](https://LATTICESEMI.COM/AUTOMATE)

# FPGA Products

## General Purpose FPGAs

| Features                                    |                                |            | Avant-AT-E                               |               |               | Avant-AT-G  |                    |                    | Avant-AT-X  |                    |                    |
|---|--------------------------------|------------|--|---------------|---------------|---|--------------------|--------------------|---|--------------------|--------------------|
| Device                                      |                                |            | E30                                      | E50           | E70           | G30   | G50                | G70                | X30   | X50                | X70                |
| System Logic Cells (k)                      |                                |            | 262                                      | 409           | 637           | 262   | 409                | 637                | 262   | 409                | 637                |
| Look-Up-Tables (k LUTs)                     |                                |            | 163                                      | 255           | 397           | 163   | 255                | 397                | 163   | 255                | 397                |
| EBR SRAM                                    | Blocks                         |            | 400                                      | 630           | 990           | 400   | 630                | 990                | 400   | 630                | 990                |
|   | Mbits                          |            | 14.4                                     | 22.7          | 35.6          | 14.4  | 22.7               | 35.6               | 14.4  | 22.7               | 35.6               |
| Distributed RAM                             | kbits                          |            | 1700                                     | 2660          | 4140          | 1700  | 2660               | 4140               | 1700  | 2660               | 4140               |
| DSP Blocks                                  | 18 x 18 Multipliers            |            | 700                                      | 1120          | 1800          | 700   | 1120               | 1800               | 700   | 1120               | 1800               |
|   | 8 x 8 <sup>1</sup> Multipliers |            | 2800                                     | 4480          | 7200          | 2800  | 4480               | 7200               | 2800  | 4480               | 7200               |
| High Frequency Oscillator                   |                                |            | 1  |               |               | 1   |                    |                    | 1   |                    |                    |
| GPLL  |                                |            | 7  | 9             | 11            | 7   | 9                  | 11                 | 7   | 9                  | 11                 |
| External Memory Interface                   |                                |            | LPDDR4 / DDR4                            |               |               | LPDDR4 / DDR4                                     |                    |                    | LPDDR4 / DDR4 / DDR5                              |                    |                    |
| SerDes Maximum Speed (Gbps)                 |                                |            |  |               |               | 12.5  |                    |                    | 25  |                    |                    |
| SerDes Protocols                            |                                |            |  |               |               | PCIe Gen 1 / 2 / 3, 10GE                          |                    |                    | PCIe Gen 1 / 2 / 3 / 4, 25GE                      |                    |                    |
| Security                                    |                                |            |  |               |               | Bitstream Encryption and Authentication           |                    |                    | Avant-G features + User Security                  |                    |                    |
| Temp.                                       | C / I                          |            | ✓  |               |               | ✓   |                    |                    | ✓   |                    |                    |
| 0.5 mm Spacing (Package type, #Balls, Size) |                                |            | Total I/O (Wide Range, High Performance) |               |               | Total I/O (Wide Range, High Performance) / SerDes |                    |                    | Total I/O (Wide Range, High Performance) / SerDes |                    |                    |
| ASG (FOWLP)                                 | 410                            | 11 x 9 mm  | 247 (94, 153)                            |               |               | 196 (43, 153) / 4                                 |                    |                    | 196 (43, 153) / 4                                 |                    |                    |
| CSG (FCCSP)                                 | 484                            | 12 x 12 mm |  |               |               |   | 218 (43, 175) / 8  |                    |   | 218 (43, 175) / 8  |                    |
| CSG (FCCSP)                                 | 841                            | 15 x 13 mm |  |               | 520 (94, 408) |   |                    | 303 (43, 260) / 8  |   |                    | 303 (43, 260) / 8  |
| 0.8 mm Spacing (Package type, #Balls, Size) |                                |            | Total I/O (Wide Range, High Performance) |               |               | Total I/O (Wide Range, High Performance) / SerDes |                    |                    | Total I/O (Wide Range, High Performance) / SerDes |                    |                    |
| CBG (FCCSP)                                 | 484                            | 19 x 19 mm | 329 (94, 235)                            | 329 (94, 235) | 349 (94, 255) |   |                    |                    |   |                    |                    |
| LBG (FCBGA)                                 | 484                            | 19 x 19 mm |  |               |               | 218 (43, 175) / 8                                 | 218 (43, 175) / 8  |                    | 218 (43, 175) / 8                                 | 218 (43, 175) / 8  |                    |
| 1.0 mm Spacing (Package type, #Balls, Size) |                                |            | Total I/O (Wide Range, High Performance) |               |               | Total I/O (Wide Range, High Performance) / SerDes |                    |                    | Total I/O (Wide Range, High Performance) / SerDes |                    |                    |
| LFG (FCBGA)                                 | 676                            | 27 x 27 mm |  |               | 297 (42, 255) | 298 (43, 255) / 12                                | 298 (43, 255) / 16 | 298 (43, 255) / 16 | 298 (43, 255) / 12                                | 298 (43, 255) / 16 | 298 (43, 255) / 16 |
|   | 1156                           | 35 x 35 mm |  |               | 553 (94, 459) |   |                    | 554 (95, 459) / 28 |   |                    | 554 (95, 459) / 28 |

1) One 18 x 18 multiplier fractures into four 8 x 8 multipliers

# FPGA Products

## General Purpose FPGAs

| Features   |                     |            | CertusPro™-NX   |                                    | Certus™-NX   |                                   |
|--|---------------------|------------|---|------------------------------------|--|-----------------------------------|
| Device   |                     |            | LFCPNX-50   | LFCPNX-100                         | LFD2NX-17  | LFD2NX-40                         |
| Logic Cells <sup>1</sup> (k)                       |                     |            | 52  | 96                                 | 17   | 39                                |
| EBR SRAM   | Blocks              |            | 96  | 208                                | 24   | 84                                |
|  | kbits               |            | 1728  | 3744                               | 432  | 1512                              |
| Distributed RAM                                    | kbits               |            | 344   | 639                                | 80   | 240                               |
| Large RAM (LRAM)                                   | Blocks              |            | 4   | 7                                  | 5  | 2                                 |
|  | kbits               |            | 2048  | 3584                               | 2560   | 1024                              |
| DSP Blocks   | 18 x 18 Multipliers |            | 96  | 156                                | 24   | 56                                |
| PCIe Hard IP                                       |                     |            | 1 (Gen3, 8 Gbps)  | 1 (Gen3, 8 Gbps)                   |  | 1 (Gen2, 5 Gbps)                  |
| PCIe Lanes   |                     |            | 4   | 4                                  |  | 1                                 |
| SERDES maximum speed                               | Gbps                |            | 10 <sup>5</sup>   | 10 <sup>5</sup>                    |  | 5                                 |
| SGMII (1.25 Gbps) CDR Hard IP                      |                     |            | 2   | 2                                  | 2  | 2                                 |
| SGMII (1.25 Gbps) Lanes                            |                     |            | 2   | 2                                  | 2  | 2                                 |
| GPLL   |                     |            | 3   | 4                                  | 2  | 3                                 |
| ADC Blocks   |                     |            | 2   | 2                                  | 2  | 2                                 |
| 450 MHz High Frequency Oscillator                  |                     |            | 1   | 1                                  | 1  | 1                                 |
| 128 KHz Low Power Oscillator                       |                     |            | 1   | 1                                  | 1  | 1                                 |
| DDR Memory Support (Up to 1066 Mbps)               |                     |            | LPDDR4, LPDDR2, DDR3/3L   |                                    | LPDDR2, DDR3/3L  |                                   |
| Boot Flash   |                     |            | External  |                                    | External   |                                   |
| Dual Boot  |                     |            | ✓   |                                    | ✓  |                                   |
| Multiple Boot                                      |                     |            | ✓   |                                    | ✓  |                                   |
| Bitstream Encryption (AES-256)                     |                     |            | ✓   |                                    | ✓  |                                   |
| Bitstream Authentication (ECDSA)                   |                     |            | ✓   |                                    | ✓  |                                   |
| Full-chip Configuration Time <sup>2</sup> (ms)     |                     |            | 29  | 29                                 | 8  | 14                                |
| I/O Configuration Time <sup>2</sup> (ms)           |                     |            | 4   | 4                                  | 3  | 3                                 |
| Core Vcc   |                     |            | 1.0 V   |                                    | 1.0 V  |                                   |
| Temp.  | C                   |            | ✓   |                                    | ✓  |                                   |
|  | I                   |            | ✓   |                                    | ✓  |                                   |
|  | A (AEC-Q100)        |            | ✓   |                                    | ✓  |                                   |
| <b>0.5 mm Spacing (Package type, #Balls, Size)</b> |                     |            | <b>Total I/O (Wide Range, High Performance, ADC<sup>3</sup>) / SERDES Lanes</b> |                                    | <b>Total I/O (Wide Range, High Performance, ADC<sup>3</sup>) / PCIe Lane<sup>6</sup></b> |                                   |
| csfBGA   | 121                 | 6 x 6 mm   |   |                                    | 77 (23, 48, 6) / 0   | 81 (23, 58, 0) / 1                |
| ASG256   | 256                 | 9 x 9 mm   | 165 (75, 84, 6) / 4 <sup>4</sup>  | 165 (75, 84, 6) / 4 <sup>4</sup>   |  |                                   |
| <b>0.8 mm Spacing (Package type, #Balls, Size)</b> |                     |            | <b>Total I/O (Wide Range, High Performance, ADC<sup>3</sup>) / SERDES Lanes</b> |                                    | <b>Total I/O (Wide Range, High Performance, ADC<sup>3</sup>) / PCIe Lane<sup>6</sup></b> |                                   |
| caBGA  | 196                 | 12 x 12 mm |   |                                    |  | 156 (92, 58, 6) / 0               |
|  | 256                 | 14 x 14 mm |   |                                    |  | 191 (111, 74, 6) / 1 <sup>4</sup> |
| CBG256   | 256                 | 14 x 14 mm | 165 (75, 84, 6) / 4 <sup>4</sup>  | 165 (75, 84, 6) / 4 <sup>4</sup>   |  |                                   |
| BBG484   | 484                 | 19 x 19 mm | 269 (167, 96, 6) / 4 <sup>4</sup>   | 305 (167, 132, 6) / 8 <sup>4</sup> |  |                                   |
| <b>1.0 mm Spacing (Package type, #Balls, Size)</b> |                     |            | <b>Total I/O (Wide Range, High Performance, ADC<sup>3</sup>) / SERDES Lanes</b> |                                    | <b>Total I/O (Wide Range, High Performance, ADC<sup>3</sup>) / PCIe Lane<sup>6</sup></b> |                                   |
| BFG484   | 484                 | 23 x 23 mm | 269 (167, 96, 6) / 4  | 305 (167, 132, 6) / 4              |  |                                   |
| LFG672   | 672                 | 27 x 27 mm |   | 305 (167, 132, 6) / 8              |  |                                   |

1) Logic Cells = LUTs x 1.2 effectiveness

2) QSPI mode at 150 MHz nominal frequency

3) Each ADC pin count reflects using dedicated complement pair and vRef

4) Available in Automotive Grade

5) 8Gbps for Automotive Grade

6) Each PCIe lane consists of a Tx and Rx complement pair

# FPGA Products

## General Purpose FPGAs

| Features              |              |            | ECP5™-5G                        |             |             | ECP5 Automotive                 |           |          | ECP5™                           |           |           |          |          |          | LatticeECP3™                |           |           |           |           |            |
|-----------------------|--------------|------------|---------------------------------|-------------|-------------|---------------------------------|-----------|----------|---------------------------------|-----------|-----------|----------|----------|----------|-----------------------------|-----------|-----------|-----------|-----------|------------|
| Device                |              |            | LFE5UM5G-25                     | LFE5UM5G-45 | LFE5UM5G-85 | LAE5UM-25                       | LAE5UM-45 | LAE5U-12 | LFE5UM-25                       | LFE5UM-45 | LFE5UM-85 | LFE5U-12 | LFE5U-25 | LFE5U-45 | LFE5U-85                    | LFE3-17EA | LFE3-35EA | LFE3-70EA | LFE3-95EA | LFE3-150EA |
| LUTs                  |              |            | 24 k                            | 44 k        | 84 k        | 24 k                            | 44 k      | 12 k     | 24 k                            | 44 k      | 84 k      | 12 k     | 24 k     | 44 k     | 84 k                        | 17 k      | 33 k      | 67 k      | 92 k      | 149 k      |
| EBR SRAM              | # of Blocks  |            | 56                              | 108         | 208         | 56                              | 108       | 32       | 56                              | 108       | 208       | 32       | 56       | 108      | 208                         | 38        | 72        | 240       | 240       | 372        |
|                       | kbits        |            | 1008                            | 1944        | 3744        | 1008                            | 1944      | 576      | 1008                            | 1944      | 3744      | 576      | 1008     | 1944     | 3744                        | 700       | 1,327     | 4,420     | 4,420     | 6,850      |
| Distrib RAM           | kbits        |            | 194                             | 351         | 669         | 194                             | 351       | 97       | 194                             | 351       | 669       | 97       | 194      | 351      | 669                         | 36        | 68        | 145       | 188       | 303        |
| sysDSP™ Blocks        | Multipliers  |            | 28                              | 72          | 156         | 28                              | 72        | 28       | 28                              | 72        | 156       | 28       | 28       | 72       | 156                         | 24        | 64        | 128       | 128       | 320        |
| SERDES                | Max. Chan.   |            | 1/2                             | 2/4         | 1/2         | 2/4                             | 0         | 1/2      | 2/4                             | 0         | 0         | 0        | 0        | 0        | 4                           | 12        | 16        | 16        | 16        |            |
|                       | Max. Rate    |            | 5 Gbps                          |             |             | 3.2 Gbps                        |           |          | 3.2 Gbps                        |           |           |          |          |          | 3.2 Gbps                    |           |           |           |           |            |
| PLL + DLL             |              |            | 2+2                             | 4+4         | 2+2         | 4+4                             | 2+2       | 2+2      | 4+4                             | 2+2       | 2+2       | 4+4      | 2+2      | 4+4      | 2+2                         | 4+2       | 10+2      |           |           |            |
| DDR Support           |              |            | DDR3 800, LPDDR3 800, DDR3L 800 |             |             | DDR3 800, LPDDR3 800, DDR3L 800 |           |          | DDR3 800, LPDDR3 800, DDR3L 800 |           |           |          |          |          | DDR3 800, DDR2 533, DDR 400 |           |           |           |           |            |
| Boot Flash            |              |            | External                        |             |             | External                        |           |          | External                        |           |           |          |          |          | External                    |           |           |           |           |            |
| Dual Boot             |              |            | ✓                               |             |             | ✓                               |           |          | ✓                               |           |           |          |          |          | ✓                           |           |           |           |           |            |
| Multiple Boot         |              |            | ✓                               |             |             | ✓                               |           |          | ✓                               |           |           |          |          |          |                             |           |           |           |           |            |
| Bit-stream Encryption |              |            | ✓                               |             |             | ✓                               |           |          | ✓                               |           |           |          |          |          | ✓                           |           |           |           |           |            |
| Core Vcc              |              |            | 1.2 V                           |             |             | 1.1 V                           |           |          | 1.1 V                           |           |           |          |          |          | 1.2 V                       |           |           |           |           |            |
| Temp.                 | C            |            | ✓                               |             |             |                                 |           |          | ✓                               |           |           |          |          |          | ✓                           |           |           |           |           |            |
|                       | I            |            | ✓                               |             |             |                                 |           |          | ✓                               |           |           |          |          |          | ✓                           |           |           |           |           |            |
|                       | A (AEC-Q100) |            |                                 |             |             | ✓                               |           |          |                                 |           |           |          |          |          | ✓                           |           |           |           |           |            |
| 0.5 mm Spacing        |              |            | I/O Count / SERDES              |             |             | I/O Count / SERDES              |           |          | I/O Count / SERDES              |           |           |          |          |          |                             |           |           |           |           |            |
| TQFP                  | 144          | 20 x 20 mm |                                 |             |             |                                 |           |          |                                 |           |           | 98/0     | 98/0     | 98/0     |                             |           |           |           |           |            |
| csfBGA                | 285          | 10 x 10 mm | 118/2                           | 118/2       | 118/2       |                                 |           |          | 118/2                           | 118/2     | 118/2     | 118/0    | 118/0    | 118/0    | 118/0                       |           |           |           |           |            |
| csBGA                 | 328          | 10 x 10 mm |                                 |             |             |                                 |           |          |                                 |           |           |          |          |          | 116/2                       |           |           |           |           |            |
| 0.8 mm Spacing        |              |            | I/O Count / SERDES              |             |             | I/O Count / SERDES              |           |          | I/O Count / SERDES              |           |           |          |          |          |                             |           |           |           |           |            |
| caBGA                 | 256          | 14 x 14 mm |                                 |             |             |                                 |           |          |                                 |           |           | 197/0    | 197/0    | 197/0    |                             |           |           |           |           |            |
|                       | 381          | 17 x 17 mm | 197/2                           | 203/4       | 205/4       | 197/2                           | 203/4     | 197/0    | 197/2                           | 203/4     | 205/4     | 197/0    | 197/0    | 203/0    | 205/0                       |           |           |           |           |            |
|                       | 554          | 23 x 23 mm |                                 | 245/4       | 259/4       |                                 |           |          |                                 | 245/4     | 259/4     |          |          | 245/0    | 259/0                       |           |           |           |           |            |
|                       | 756          | 27 x 27 mm |                                 |             | 365/4       |                                 |           |          |                                 |           | 365/4     |          |          |          | 365/0                       |           |           |           |           |            |
| 1.0 mm Spacing        |              |            | I/O Count / SERDES              |             |             | I/O Count / SERDES              |           |          | I/O Count / SERDES              |           |           |          |          |          |                             |           |           |           |           |            |
| ftBGA                 | 256          | 17 x 17 mm |                                 |             |             |                                 |           |          |                                 |           |           |          |          |          | 133/4                       | 133/4     |           |           |           |            |
| fpBGA                 | 484          | 23 x 23 mm |                                 |             |             |                                 |           |          |                                 |           |           |          |          |          | 222/4                       | 295/4     | 295/4     | 295/4     |           |            |
|                       | 672          | 27 x 27 mm |                                 |             |             |                                 |           |          |                                 |           |           |          |          |          |                             | 310/4     | 380/8     | 380/8     | 380/8     |            |
|                       | 1156         | 35 x 35 mm |                                 |             |             |                                 |           |          |                                 |           |           |          |          |          |                             |           | 490/12    | 490/12    | 586/16    |            |

# Video Connectivity

## CrossLink Series – Embedded Vision FPGAs

| Features                      |              |              | CrossLink™                 |                   |                  |                   |                   |                  |                   | CrossLinkPlus™    |                    |                    |
|-------------------------------|--------------|--------------|----------------------------|-------------------|------------------|-------------------|-------------------|------------------|-------------------|-------------------|--------------------|--------------------|
| Device                        |              |              | LIF-MD6000-6UWG36          | LIF-MD6000-6UMG64 | LIF-MD6000-6MG81 | LIF-MD6000-6JMG80 | LIF-MD6000-6KMG80 | LIA-MD6000-6MG81 | LIA-MD6000-6JMG80 | LIA-MD6000-6KMG80 | LIF-MDF6000-6UMG64 | LIF-MDF6000-6KMG80 |
| LCs (k)                       |              |              | 7                          |                   |                  |                   |                   |                  |                   | 7                 | 7                  |                    |
| EBR SRAM                      | Blocks       |              | 20                         |                   |                  |                   |                   |                  |                   | 20                | 20                 |                    |
|                               | kbits        |              | 180                        |                   |                  |                   |                   |                  |                   | 180               | 180                |                    |
| Distributed RAM               | kbits        |              | 47                         |                   |                  |                   |                   |                  |                   | 47                | 47                 |                    |
| MIPI D-PHY                    | Port         |              | 1                          |                   | 2                |                   |                   |                  |                   | 2                 | 2                  |                    |
|                               | Lane         |              | 4                          |                   | 8                |                   |                   |                  |                   | 8                 | 8                  |                    |
|                               | Max Rate     |              | 1.5 Gbps                   |                   |                  |                   |                   |                  |                   | 1.5 Gbps          | 1.5 Gbps           |                    |
| GPLL                          |              |              | 1                          |                   |                  |                   |                   |                  |                   | 1                 | 1                  |                    |
| Edge Clock                    |              |              | 2                          |                   | 4                |                   |                   |                  |                   | 4                 | 4                  |                    |
| Boot Flash                    |              |              | External                   |                   |                  |                   |                   |                  |                   | Internal          | Internal           |                    |
| Dual Boot                     |              |              | External                   |                   |                  |                   |                   |                  |                   | External          | External           |                    |
| Internal Configuration Memory |              |              | NVCM                       |                   |                  |                   |                   |                  |                   | Flash             | Flash              |                    |
| Temp                          | C            |              | ✓                          |                   |                  |                   |                   |                  |                   | ✓                 | ✓                  |                    |
|                               | I            |              | ✓                          |                   |                  |                   |                   |                  |                   | ✓                 | ✓                  |                    |
|                               | A (AEC-Q100) |              |                            |                   |                  |                   | ✓                 | ✓                | ✓                 |                   |                    |                    |
| 0.4 mm Pitch                  |              |              | I/O (Low Speed/High Speed) |                   |                  |                   |                   |                  |                   | I/O (L/H)         |                    |                    |
| WLCSP                         | 36           | 2.5 x 2.5 mm | 17/10                      |                   |                  |                   |                   |                  |                   |                   |                    |                    |
| ucfBGA                        | 64           | 3.5 x 3.5 mm |                            | 29/22             |                  |                   |                   |                  |                   |                   | 29/22              |                    |
| 0.5 mm Pitch                  |              |              | I/O (Low Speed/High Speed) |                   |                  |                   |                   |                  |                   | I/O (L/H)         |                    |                    |
| csfBGA                        | 81           | 4.5 x 4.5 mm |                            |                   | 37/30            |                   |                   | 37/30            |                   |                   |                    |                    |
| 0.65 mm Pitch                 |              |              | I/O (Low Speed/High Speed) |                   |                  |                   |                   |                  |                   | I/O (L/H)         |                    |                    |
| ctfBGA                        | 80           | 6.5 x 6.5 mm |                            |                   | 37/30            |                   |                   | 37/30            |                   |                   |                    |                    |
| ckfBGA                        | 80           | 7 x 7 mm     |                            |                   |                  | 37/30             |                   |                  | 37/30             |                   |                    | 37/30              |

# Video Connectivity

## CrossLink Series – Embedded Vision FPGAs

| Features                   |              |              | CrossLink™-NX  |                       |                       |                         |
|----------------------------|--------------|--------------|--|-----------------------|-----------------------|-------------------------|
| Device                     |              |              | LIFCL-17   | LIFCL-33              | LIFCL-33U             | LIFCL-40                |
| LCs (k)                    |              |              | 17   | 33                    | 33                    | 39                      |
| EBR SRAM                   | Blocks       |              | 24   | 64                    | 64                    | 84                      |
|                            | kbits        |              | 432  | 1152                  | 1152                  | 1512                    |
| Distributed RAM            | kbits        |              | 80   | 220                   | 220                   | 240                     |
| Large Memory (LDRAM)       | Blocks       |              | 5  | 5                     | 5                     | 2                       |
|                            | kbits        |              | 2560   | 2560                  | 2560                  | 1024                    |
| sysDSP™ Blocks             | 18 x 18      |              | 24   | 64                    | 64                    | 56                      |
| MIPI D-PHY                 | Ports        |              | 2  | -                     | -                     | 2                       |
|                            | Lanes        |              | 8  | -                     | -                     | 8                       |
| PCIe (5 Gbps)              | Lanes        |              | -  | -                     | -                     | 1                       |
| USB 2.0 / USB 3.2 (5 Gbps) |              |              | -  | -                     | 1 / 1                 | -                       |
| GPLL                       |              |              | 2  | 1                     | 1                     | 3                       |
| Boot Flash                 |              |              | External   |                       |                       |                         |
| Dual Boot                  |              |              | External   |                       |                       |                         |
| Multiple Boot              |              |              | X  |                       |                       |                         |
| Bit-stream Encryption      |              |              | X  |                       |                       |                         |
| Temp                       | C            |              | x  | x                     | x                     | x                       |
|                            | I            |              | x  | x                     | x                     | x                       |
|                            | A (AEC-Q100) |              | x  |                       |                       | x                       |
| 0.4 mm Pitch               |              |              | Total I/O (Wide Range, High Performance, ADC <sup>1</sup> ) (D-PHY Quads <sup>2</sup> , PCIe Lane <sup>3</sup> ) |                       |                       |                         |
| WLCSP                      | 72           | 3.7 x 4.1 mm | 45 (15, 24, 6) (1, 0)  |                       |                       |                         |
| 0.5 mm Pitch               |              |              | Total I/O (Wide Range, High Performance, ADC <sup>1</sup> ) (D-PHY Quads <sup>2</sup> , PCIe Lane <sup>3</sup> ) |                       |                       |                         |
| QFN                        | 72           | 10 x 10 mm   | 46 (18, 22, 6) (1, 0)  |                       |                       | 45 (17, 22, 6) (1, 0)   |
| WLCSP                      | 84           | 3.1 x 7.3 mm |  | 60 (34, 26, 0) (0, 0) | 44 (17, 27, 0) (0, 0) |                         |
| csfBGA                     | 121          | 6 x 6 mm     | 77 (23, 48, 6) (2, 0)  |                       |                       | 77 (23, 48, 6) (2, 0)   |
| csBGA                      | 289          | 9.5 x 9.5 mm |  |                       |                       | 179 (99, 74, 6) (2, 1)  |
| 0.65 mm Pitch              |              |              | Total I/O (Wide Range, High Performance, ADC <sup>1</sup> ) (D-PHY Quads <sup>2</sup> , PCIe Lane <sup>3</sup> ) |                       |                       |                         |
| fcCSP                      | 104          | 5.5 x 8.5 mm |  |                       | 52 (20, 32, 0) (0, 0) |                         |
| 0.8 mm Pitch               |              |              | Total I/O (Wide Range, High Performance, ADC <sup>1</sup> ) (D-PHY Quads <sup>2</sup> , PCIe Lane <sup>3</sup> ) |                       |                       |                         |
| caBGA                      | 256          | 14 x 14 mm   | 77 (23, 48, 6) (2, 0)  |                       |                       | 162 (82, 74, 6) (2, 1)  |
|                            | 400          | 17 x 17 mm   |  |                       |                       | 191 (111, 74, 6) (2, 1) |

1) Each ADC pin count reflects using dedicated complement pair and vRef

2) Each D-PHY quad consists of 4 D-PHY data lanes

3) Each PCIe lane consists of a Tx and Rx complement pair



# Control and Security

## MachXO5-NX - Secure, Control Bridging and I/O Expansion FPGAs

| Features                                    |              |            | MachXO5™-NX  |   |   |
|---|--------------|------------|--|---|---|
| Device                                      |              |            | LFMXO5-25  | LFMXO5-55T                                | LFMXO5-100T                               |
| Logic Cells <sup>1</sup> (k)                |              |            | 27   | 53  | 96  |
| EBR SRAM                                    | Blocks       |            | 80   | 166                                       | 208                                       |
|   | kbits        |            | 1,440  | 2,988                                     | 3,744                                     |
| Distributed RAM                             | kbits        |            | 184  | 320                                       | 639                                       |
| Large RAM (LRAM)                            | Blocks       |            | 1  | 5   | 7   |
|   | kbits        |            | 512  | 2,560                                     | 3,584                                     |
| Multipliers                                 | 18 x 18      |            | 20   | 146                                       | 156                                       |
| PCIe Hard IP                                |              |            | 0  | 1   | 1   |
| PCIe Lanes                                  |              |            | 0  | 2   | 2   |
| SERDES maximum speed                        | Gbps         |            | 0  | 5   | 5   |
| SGMII (1.25 Gbps) CDR Hard IP               |              |            | 2  | 2   | 2   |
| SGMII (1.25 Gbps) Lanes                     |              |            | 2  | 2   | 2   |
| GPLL  |              |            | 2  | 4   | 4   |
| ADC Blocks                                  |              |            | 2  | 2   | 2   |
| 450 MHz High Frequency Oscillator           |              |            | 1  | 1   | 1   |
| 128 KHz Low Power Oscillator                |              |            | 1  | 1   | 1   |
| DDR Memory Support (Up to 1066 Mbps)        |              |            | DDR3/3L  | DDR3/3L, LPDDR4                           | DDR3/3L, LPDDR4                           |
| Non-Volatile Config Memory                  |              |            | Yes  | Yes                                       | Yes                                       |
| On-chip Multi-Boot                          |              |            | 3  | 3   | 3   |
| User Flash Memory (kb)                      |              |            | 9,216 <sup>2</sup> / 15,360 <sup>2</sup>                                   | 56,832 <sup>2</sup> / 79,872 <sup>2</sup> | 56,832 <sup>2</sup> / 79,872 <sup>2</sup> |
| Bitstream Encryption                        |              |            | AES-256  | AES-256                                   | AES-256                                   |
| Bitstream Authentication                    |              |            | ECDSA-256  | ECDSA-256                                 | ECDSA-256                                 |
| Core Vcc                                    |              |            | 1.0 V  | 1.0 V                                     | 1.0 V                                     |
| Temp.                                       | C            |            | ✓  | ✓   | ✓   |
|   | I            |            | ✓  | ✓   | ✓   |
|   | A (AEC-Q100) |            |  |   |   |
| 0.8 mm Spacing (Package type, #Balls, Size) |              |            | Total I/O (Wide Range, High Performance) / ADC <sup>3</sup> / SERDES Lanes |   |   |
| BBG256                                      | 256          | 14 x 14 mm | 199 (159, 40) / 6 / 0  | -   | -   |
| BBG400                                      | 400          | 17 x 17 mm | 299 (251, 48) / 6 / 0  | 291 (159, 132) / 6 / 2                    | 291 (159, 132) / 6 / 2                    |

1) Logic Cells = LUTs x 1.2 effectiveness

2) Initialize 100% of memory / Initialize 0% of memory

3) Dedicated inputs for ADC

# Control and Security

## Mach-NX & MachXO3/3D - Secure, Control Bridging and I/O Expansion FPGAs

| Features                   |                  |              | Mach™-NX                                 | MachXO3D™             |                        |  | MachXO3L™    |                  |              |                  |  | MachXO3LF™       |                  |                  |                  |                  |               |
|----------------------------|------------------|--------------|--|-----------------------|------------------------|--|--------------|------------------|--------------|------------------|--|------------------|------------------|------------------|------------------|------------------|---------------|
| Device                     |                  |              | LFMNX-50                                 | LCMXO3D-4300          | LCMXO3D-9400           | LCMXO3L-640                              | LCMXO3L-1300 | LCMXO3L-2100     | LCMXO3L-4300 | LCMXO3L-6900     | LCMXO3L-9400                             | LCMXO3LF-640     | LCMXO3LF-1300    | LCMXO3LF-2100    | LCMXO3LF-4300    | LCMXO3LF-6900    | LCMXO3LF-9400 |
| LUTs                       |                  |              | 11280 <sup>8</sup>                       | 4300                  | 9400                   | 640                                      | 1300         | 2100             | 4300         | 6900             | 9400                                     | 640              | 1300             | 2100             | 4300             | 6900             | 9400          |
| EBR SRAM                   | # of Blocks      |              | 48                                       | 10                    | 48                     | 7  | 7            | 8                | 10           | 26               | 48                                       | 7                | 7                | 8                | 10               | 26               | 48            |
|                            | kbits            |              | 432                                      | 92                    | 432                    | 64                                       | 64           | 74               | 92           | 240              | 432                                      | 64               | 64               | 74               | 92               | 240              | 432           |
| Distrib. RAM               | kbits            |              | 73                                       | 34                    | 73                     | 5  | 10           | 16               | 34           | 54               | 73                                       | 5                | 10               | 16               | 34               | 54               | 73            |
| UFM                        | kbits            |              | 1064/2669 <sup>4</sup>                   | 367/1122 <sup>4</sup> | 1088/2693 <sup>4</sup> |  |              |                  |              |                  |  | 64               | 64               | 80               | 96               | 256              | 448           |
| Configuration Memory       |                  |              | Dual Flash                               | Dual Flash            | Dual Flash             | Internal NVM                             |              |                  |              |                  | Flash                                    |                  |                  |                  |                  |                  |               |
| Dual Boot                  |                  |              | √ <sup>6</sup>                           | √ <sup>6</sup>        |                        | √ <sup>5</sup>                           |              |                  |              |                  | √ <sup>5</sup>                           |                  |                  |                  |                  |                  |               |
| Embedded Function Blocks   |                  |              | I <sup>2</sup> C (2), SPI (1), Timer (1) |                       |                        | I <sup>2</sup> C (2), SPI (1), Timer (1) |              |                  |              |                  | I <sup>2</sup> C (2), SPI (1), Timer (1) |                  |                  |                  |                  |                  |               |
| Crypto Key Strength (bits) |                  |              | 384                                      | 256                   | 256                    |  |              |                  |              |                  |  |                  |                  |                  |                  |                  |               |
| Core Vcc                   | 1 V              |              | √  |                       |                        |  |              |                  |              |                  |  |                  |                  |                  |                  |                  |               |
|                            | 1.2 V            |              |  | √ <sup>7</sup>        |                        |  |              | √                |              |                  |  |                  |                  | √                |                  |                  |               |
|                            | 2.5 - 3.3 V      |              |  | √                     | √                      |  |              | √                |              |                  |  |                  |                  | √                |                  |                  |               |
| Temp.                      | A (AEC-Q100)     |              |  | √                     | √                      |  |              |                  |              |                  |  |                  | √                |                  |                  |                  |               |
|                            | C                |              | √  | √                     | √                      |  |              | √                |              |                  |  |                  |                  | √                |                  |                  |               |
|                            | I                |              | √  | √                     | √                      |  |              | √                |              |                  |  |                  |                  | √                |                  |                  |               |
| 0.4 mm Spacing             |                  |              |  |                       |                        |  |              |                  |              | Total I/Os       |  |                  |                  |                  |                  |                  |               |
| WLCSP                      | 36 <sup>1</sup>  | 2.5 x 2.5 mm |  |                       |                        |  | 28           |                  |              |                  |  |                  | 28               |                  |                  |                  |               |
|                            | 49 <sup>1</sup>  | 3.2 x 3.2 mm |  |                       |                        |  |              | 38               |              |                  |  |                  |                  | 38               |                  |                  |               |
|                            | 81 <sup>1</sup>  | 3.8 x 3.8 mm |  |                       |                        |  |              |                  | 63           |                  |  |                  |                  |                  | 63               |                  |               |
| 0.5 mm Spacing             |                  |              |  |                       |                        |  |              |                  |              | Total I/Os       |  |                  |                  |                  |                  |                  |               |
| QFN                        | 72               | 10 x 10 mm   |  | 58                    | 58                     |  |              |                  |              |                  |  |                  |                  |                  |                  |                  |               |
| csfBGA                     | 121 <sup>1</sup> | 6 x 6 mm     |  |                       |                        |  | 100          |                  |              |                  |  |                  | 100              |                  |                  |                  |               |
|                            | 256 <sup>1</sup> | 9 x 9 mm     |  |                       |                        |  |              | 206              |              |                  |  |                  |                  | 206              |                  |                  |               |
|                            | 324              | 10 x 10 mm   |  |                       |                        |  |              | 268              | 268          | 281              |  |                  |                  | 268 <sup>7</sup> | 268 <sup>7</sup> | 281              |               |
| csBGA                      | 132              | 8 x 8 mm     |  |                       |                        |  |              |                  |              |                  | 104 <sup>7</sup>                         | 104 <sup>7</sup> | 104 <sup>7</sup> | 104 <sup>7</sup> |                  |                  |               |
| TQFP                       | 100              | 14 x 14 mm   |  |                       |                        |  |              |                  |              |                  | 79 <sup>7</sup>                          | 79 <sup>7</sup>  | 79 <sup>7</sup>  |                  |                  |                  |               |
| 0.65 mm Spacing            |                  |              |  |                       |                        |  |              |                  |              | Total I/Os       |  |                  |                  |                  |                  |                  |               |
| WLCSP                      | 69 <sup>1</sup>  | 5.2 x 6.2 mm |  |                       | 58                     |  |              |                  |              |                  |  |                  |                  |                  |                  |                  |               |
| 0.8 mm Spacing             |                  |              |  |                       |                        |  |              |                  |              | Total I/Os       |  |                  |                  |                  |                  |                  |               |
| caBGA                      | 256              | 14 x 14 mm   | 188                                      | 206 <sup>7</sup>      | 206 <sup>7</sup>       |  |              | 206 <sup>2</sup> |              | 206 <sup>3</sup> |  |                  | 206 <sup>7</sup> |                  | 206 <sup>2</sup> | 206 <sup>3</sup> |               |
|                            | 324              | 15 x 15 mm   |  |                       |                        |  |              | 279 <sup>2</sup> |              |                  |  |                  | 279 <sup>7</sup> |                  | 279 <sup>2</sup> |                  |               |
|                            | 400              | 17 x 17 mm   |  |                       | 335                    |  |              | 335 <sup>2</sup> |              | 335 <sup>3</sup> |  |                  |                  | 335 <sup>2</sup> | 335 <sup>3</sup> |                  |               |
|                            | 484              | 19 x 19 mm   | 378                                      |                       | 383 <sup>7</sup>       |  |              |                  |              | 384 <sup>3</sup> |  |                  |                  |                  |                  | 384 <sup>3</sup> |               |

- 1) Package is only available for E=1.2 V devices.
- 2) Package is only available for C=2.5 V/3.3 V devices.
- 3) Package is available for both E=1.2 V and C=2.5 V/3.3 V devices.
- 4) When Dual Boot is disabled, image space can be repurposed as extra UFM.
- 5) Dual Boot supported with external boot Flash.
- 6) Dual Boot is supported by on chip dual configuration flash memory.
- 7) Available in automotive grade
- 8) Shown in LCs

# Control and Security

## MachXO2 & LatticeXP2 Series – Bridging and I/O Expansion FPGAs

| Features                 |                  |              | MachXO2™        |                 |  |                             |                |             |                | LatticeXP2™      |               |                |            |             |             |             |  |
|--------------------------|------------------|--------------|-----------------|-----------------|--|-----------------------------|----------------|-------------|----------------|------------------|---------------|----------------|------------|-------------|-------------|-------------|--|
| Device                   |                  |              | LCMXO2 - 256    | LCMXO2 - 640    | LCMXO2 - 640U                            | LCMXO2 - 1200               | LCMXO2 - 1200U | LCMXO2-2000 | LCMXO2 - 2000U | LCMXO2 - 4000    | LCMXO2 - 7000 | LFXP2 - 5E     | LFXP2 - 8E | LFXP2 - 17E | LFXP2 - 30E | LFXP2 - 40E |  |
| LUTs                     |                  |              | 256             | 640             | 640                                      | 1280                        | 1280           | 2112        | 2112           | 4320             | 6864          | 5 k            | 8 k        | 17 k        | 29 k        | 40 k        |  |
| EBR SRAM                 | # of Blocks      |              | 0               | 2               | 7  | 7                           | 8              | 8           | 10             | 10               | 26            | 9              | 12         | 15          | 21          | 48          |  |
| kbits                    |                  |              | 0               | 18              | 64                                       | 64                          | 74             | 74          | 92             | 92               | 240           | 166            | 221        | 276         | 387         | 885         |  |
| Distrib. RAM             | kbits            |              | 2               | 5               | 5  | 10                          | 10             | 16          | 16             | 34               | 54            | 10             | 18         | 35          | 56          | 83          |  |
| UFM                      | kbits            |              | 0               | 24              | 64                                       | 64                          | 80             | 80          | 96             | 96               | 256           |                |            |             |             |             |  |
| sysDSP™ Blocks           | 18x18 Blocks     |              |                 |                 |  |                             |                |             |                |                  |               | 3              | 4          | 5           | 7           | 8           |  |
|                          | Multipliers      |              |                 |                 |  |                             |                |             |                |                  |               | 12             | 16         | 20          | 28          | 32          |  |
| PLL + DLL                |                  |              |                 |                 |  | 1+2                         |                |             | 2+2            |                  |               | 2+0            |            |             | 4+0         |             |  |
| DDR Support              |                  |              |                 |                 |  | DDR 266, DDR2 266, LPDDR266 |                |             |                |                  |               | DDR/2 400      |            |             |             |             |  |
| Configuration Memory     |                  |              |                 |                 |  | Internal Flash              |                |             |                |                  |               | Internal Flash |            |             |             |             |  |
| Dual Boot <sup>4</sup>   |                  |              |                 |                 |  | ✓                           |                |             |                |                  |               | ✓              |            |             |             |             |  |
| Bit-stream Encryption    |                  |              |                 |                 |  |                             |                |             |                |                  |               | ✓              |            |             |             |             |  |
| Embedded Function Blocks |                  |              |                 |                 | I <sup>2</sup> C (2), SPI (1), Timer (1) |                             |                |             |                |                  |               |                |            |             |             |             |  |
| Core Vcc                 | 1.2 V            |              |                 |                 |  | ZE & HE                     |                |             |                |                  |               | ✓              |            |             |             |             |  |
|                          | 1.8 - 3.3 V      |              |                 |                 |  |                             |                |             |                |                  |               |                |            |             |             |             |  |
|                          | 2.5 - 3.3 V      |              |                 |                 |  | HC                          |                |             |                |                  |               | HC             |            |             |             |             |  |
| Temp.                    | C                |              |                 |                 |  | ✓                           |                |             |                |                  |               | ✓              |            |             |             |             |  |
|                          | I                |              |                 |                 |  | ✓                           |                |             |                |                  |               | ✓              |            |             |             |             |  |
|                          | A (AEC-Q100)     |              | ✓               |                 |  |                             |                |             |                |                  |               | ✓              |            |             |             |             |  |
| <b>0.4 mm Spacing</b>    |                  |              |                 |                 |  |                             |                |             |                |                  |               |                |            |             |             |             |  |
| WLCSP                    | 25               | 2.5 x 2.5 mm |                 |                 |  | 18                          |                |             | 18             |                  |               |                |            |             |             |             |  |
|                          | 36               | 2.5 x 2.5 mm |                 |                 |  | 28                          |                |             |                |                  |               |                |            |             |             |             |  |
|                          | 49 <sup>2</sup>  | 3.2 x 3.2 mm |                 |                 |  |                             |                | 38          |                |                  |               |                |            |             |             |             |  |
|                          | 81               | 3.8 x 3.8 mm |                 |                 |  |                             |                |             |                | 63               |               |                |            |             |             |             |  |
| ucBGA                    | 64               | 4 x 4 mm     | 44              |                 |  |                             |                |             |                |                  |               |                |            |             |             |             |  |
| <b>0.5 mm Spacing</b>    |                  |              |                 |                 |  |                             |                |             |                |                  |               |                |            |             |             |             |  |
| QFN                      | 32               | 5 x 5 mm     | 21              |                 |  |                             | 21             |             |                |                  |               |                |            |             |             |             |  |
|                          | 48               | 7 x 7 mm     | 40              | 40              |  |                             |                |             |                |                  |               |                |            |             |             |             |  |
|                          | 84               | 7 x 7 mm     |                 |                 |  |                             |                |             |                | 68               |               |                |            |             |             |             |  |
| csBGA                    | 100              | 8 x 8 mm     |                 |                 |  |                             |                |             |                |                  |               |                |            |             |             |             |  |
|                          | 132              | 8 x 8 mm     | 55 <sup>5</sup> | 79 <sup>5</sup> |  | 104                         |                | 104         |                | 104              |               |                |            |             |             |             |  |
|                          | 184 <sup>1</sup> | 8 x 8 mm     |                 |                 |  |                             |                |             |                | 150 <sup>1</sup> |               |                |            |             |             |             |  |
| csfBGA                   | 132              | 8 x 8 mm     |                 |                 |  |                             |                |             |                |                  | 86            |                |            |             |             |             |  |
| TQFP                     | 100              | 14 x 14 mm   | 55 <sup>5</sup> | 78 <sup>5</sup> |  | 79                          |                | 79          |                |                  |               |                |            |             |             |             |  |
|                          | 144              | 20 x 20 mm   |                 |                 | 107                                      | 107                         |                | 111         |                | 114              | 114           | 100            |            |             |             |             |  |
| <b>0.8 mm Spacing</b>    |                  |              |                 |                 |  |                             |                |             |                |                  |               |                |            |             |             |             |  |
| caBGA                    | 256              | 14 x 14 mm   |                 |                 |  |                             |                | 206         |                | 206              | 206           |                |            |             |             |             |  |
|                          | 332              | 17 x 17 mm   |                 |                 |  |                             |                |             |                | 274              | 278           |                |            |             |             |             |  |
| <b>1.0 mm Spacing</b>    |                  |              |                 |                 |  |                             |                |             |                |                  |               |                |            |             |             |             |  |
| ftBGA                    | 256              | 17 x 17 mm   |                 |                 |  | 206                         | 206            |             | 206            | 206              | 172           |                | 201        |             |             |             |  |
|                          | 324              | 19 x 19 mm   |                 |                 |  |                             |                |             |                |                  |               |                |            |             |             |             |  |
| fpBGA                    | 484              | 23 x 23 mm   |                 |                 |  |                             |                | 278         | 278            | 334              |               |                | 358        |             | 363         |             |  |
|                          | 672              | 27 x 27 mm   |                 |                 |  |                             |                |             |                |                  |               |                |            | 472         | 540         |             |  |

1) Contact your Lattice sales representative for the support of the 184-ball csBGA package, available with the HE option only.

2) Package is only available for E=1.2 V devices.

3) Package is only available for C=2.5 V/3.3 V devices.

4) Dual Boot supported with external boot Flash.

5) Available in automotive grade

# Ultra Low Power

## iCE40 Series – World's Smallest FPGAs

| Features                   |        |                | iCE40 UltraPlus                                  |       | iCE40 UltraLite |       | iCE40 Ultra |       |       | iCE40 LP           |                    |                    |                    | iCE40 HX |        |  |
|----------------------------|--------|----------------|--|-------|-----------------|-------|-------------|-------|-------|--------------------|--------------------|--------------------|--------------------|----------|--------|--|
| Device                     | UP3K   | UP5K           | UL640  | UL1K  | LP1K            | LP2K  | LP4K        | LP384 | LP640 | LP1K               | LP4K               | LP8K               | HX1K               | HX4K     | HX8K   |  |
| Logic                      | 2800   | 5280           | 640  | 1248  | 1100            | 2048  | 3520        | 384   | 640   | 1280               | 3520               | 7680               | 1280               | 3520     | 7680   |  |
| NVCM                       | Yes    | Yes            | Yes  | Yes   | Yes             | Yes   | Yes         | Yes   | Yes   | Yes                | Yes                | Yes                | Yes                | Yes      | Yes    |  |
| Static Power (µA)          | 75     | 75             | 35   | 35    | 71              | 71    | 71          | 21    | 100   | 100                | 250                | 250                | 296                | 1140     | 1140   |  |
| EBR                        | 80 kb  | 120 kb         | 56 kb  | 56 kb | 64 kb           | 80 kb | 80 kb       | 0     | 64 kb | 64 kb              | 80 kb              | 128 kb             | 64 kb              | 80 kb    | 128 kb |  |
| SPRAM                      | 0.5 Mb | 1 Mb           |  |       |                 |       |             |       |       |                    |                    |                    |                    |          |        |  |
| PLL                        | 1      | 1              | 1  | 1     | 1               | 1     | 1           |       |       | 1                  | 2                  | 2                  | 1                  | 2        | 2      |  |
| I <sup>2</sup> C core      | 2      | 2              | 2  | 2     | 2               | 2     | 2           |       |       |                    |                    |                    |                    |          |        |  |
| SPI Core                   | 2      | 2              |  |       | 2               | 2     | 2           |       |       |                    |                    |                    |                    |          |        |  |
| Strobe (low)               |        |                |  |       |                 |       |             |       |       |                    |                    |                    |                    |          |        |  |
| Strobe (high)              |        |                |  |       |                 |       |             |       |       |                    |                    |                    |                    |          |        |  |
| Low Power Oscillator       | 1      | 1              | 1  | 1     | 1               | 1     | 1           |       |       |                    |                    |                    |                    |          |        |  |
| High Frequency Oscillator  | 1      | 1              | 1  | 1     | 1               | 1     | 1           |       |       |                    |                    |                    |                    |          |        |  |
| 24 mA Drive                | 3      | 3              | 3  | 3     | 3               | 3     | 3           |       | 3     | 3 <sup>3</sup>     |                    |                    |                    |          |        |  |
| 100 mA + 400 mA Drive      |        |                | 1  | 1     |                 |       |             |       |       |                    |                    |                    |                    |          |        |  |
| 500 mA Drive               |        |                |  |       | 1               | 1     | 1           |       |       |                    |                    |                    |                    |          |        |  |
| Mult 16 x 16, Accum 32 bit | 4      | 8              |  |       | 2               | 4     | 4           |       |       |                    |                    |                    |                    |          |        |  |
| PWM Generator              | Yes    | Yes            | Yes  | Yes   | Yes             | Yes   | No          |       |       |                    |                    |                    |                    |          |        |  |
| <b>0.35 mm Spacing</b>     |        |                | <b>Total I/Os (Dedicated I/Os)<sup>4,5</sup></b> |       |                 |       |             |       |       |                    |                    |                    |                    |          |        |  |
| WLCSP                      | 16     | 1.40 x 1.40 mm |  |       |                 |       |             |       |       | 11(1) <sup>1</sup> | 11(1) <sup>1</sup> |                    |                    |          |        |  |
|                            | 16     | 1.40 x 1.48 mm |  |       | 10              | 10    |             |       |       |                    |                    |                    |                    |          |        |  |
|                            | 25     | 1.71 x 1.71 mm |  |       |                 |       |             |       |       |                    |                    |                    |                    |          |        |  |
|                            | 36     | 2.08 x 2.08 mm |  |       |                 |       | 27(1)       | 27(1) | 27(1) |                    |                    |                    |                    |          |        |  |
| <b>0.4 mm Spacing</b>      |        |                | <b>Total I/Os (Dedicated I/Os)<sup>4,5</sup></b> |       |                 |       |             |       |       |                    |                    |                    |                    |          |        |  |
| WLCSP                      | 30     | 2.15 x 2.55 mm | 21   | 21    |                 |       |             |       |       |                    |                    |                    |                    |          |        |  |
|                            | 36     | 2.5 x 2.5 mm   |  |       | 26              | 26    |             |       | 27(2) |                    | 27(2) <sup>1</sup> |                    |                    |          |        |  |
| ucBGA                      | 49     | 3 x 3 mm       |  |       |                 |       |             |       | 39(2) |                    | 37(2) <sup>1</sup> |                    |                    |          |        |  |
|                            | 81     | 4 x 4 mm       |  |       |                 |       |             |       |       |                    | 65(2)              | 65(2) <sup>2</sup> | 65(2) <sup>2</sup> |          |        |  |
|                            | 121    | 5 x 5 mm       |  |       |                 |       |             |       |       |                    | 97(2)              | 95(2)              | 95(2)              |          |        |  |
|                            | 225    | 7 x 7 mm       |  |       |                 |       |             |       |       |                    |                    | 180(2)             | 180(2)             |          | 180(2) |  |
| <b>0.5 mm Spacing</b>      |        |                | <b>Total I/Os (Dedicated I/Os)<sup>4,5</sup></b> |       |                 |       |             |       |       |                    |                    |                    |                    |          |        |  |
| QFN                        | 32     | 5 x 5 mm       |  |       |                 |       |             |       | 23(2) |                    |                    |                    |                    |          |        |  |
|                            | 48     | 7 x 7 mm       |  | 39    |                 |       | 39          | 39    | 39    |                    |                    |                    |                    |          |        |  |
|                            | 84     | 7 x 7 mm       |  |       |                 |       |             |       |       |                    | 69(2) <sup>1</sup> |                    |                    |          |        |  |
| csBGA                      | 81     | 5 x 5 mm       |  |       |                 |       |             |       |       |                    | 64(2) <sup>1</sup> |                    |                    |          |        |  |
|                            | 121    | 6 x 6 mm       |  |       |                 |       |             |       |       |                    | 94(2)              |                    |                    |          |        |  |
|                            | 132    | 8 x 8 mm       |  |       |                 |       |             |       |       |                    |                    |                    | 97(2)              | 97(2)    | 97(2)  |  |
| VQFP                       | 100    | 14 x 14 mm     |  |       |                 |       |             |       |       |                    |                    |                    | 74(2) <sup>1</sup> |          |        |  |
| TQFP                       | 144    | 20 x 20 mm     |  |       |                 |       |             |       |       |                    |                    |                    | 98(2)              | 109(2)   |        |  |
| <b>0.8 mm Spacing</b>      |        |                | <b>Total I/Os (Dedicated I/Os)<sup>4,5</sup></b> |       |                 |       |             |       |       |                    |                    |                    |                    |          |        |  |
| caBGA                      | 121    | 9 x 9 mm       |  |       |                 |       |             |       |       |                    |                    |                    |                    |          | 95(2)  |  |
|                            | 256    | 14 x 14 mm     |  |       |                 |       |             |       |       |                    |                    |                    |                    |          | 208(2) |  |

1) No PLL available on the 16 WLCSP, 36 ucBGA, 81 csBGA, 84 QFN and 100 VQFP packages.

2) Only one PLL available on the 81 ucBGA package.

3) 24 mA constant current sink available on the 16 WLCSP package only.

4) Total I/Os include dedicated I/Os.

5) Dedicated I/Os are defined to be pins that are dedicated and cannot be used by user logic after configuration.

# Power and Thermal Management Products

Manage power, thermal & control planes in real time

| Features                           |          | Power & Thermal Management |                       |                       |
|------------------------------------|----------|----------------------------|-----------------------|-----------------------|
|                                    |          | L-ASC10                    | LPTM21                | LPTM21L               |
| Voltage Monitoring Inputs          |          | 10                         | 10                    | 10                    |
| Current Monitoring Inputs          |          | 2                          | 2                     | 2                     |
| Temperature Monitoring Inputs      |          | 2                          | 2                     | 2                     |
| Number of Trimming Channels        |          | 4                          | 4                     | 4                     |
| MOSFET Drives                      |          | 4                          | 4                     | 4                     |
| On-Chip Non-Volatile Fault Log     |          | ✓                          | ✓                     | ✓                     |
| Number of LUTs                     |          |                            | 1280                  | 1280                  |
| Distributed RAM (kbits)            |          |                            | 10                    | 10                    |
| EBR SRAM (kbits)                   |          |                            | 64                    | 64                    |
| Number of EBR Blocks (9 kbits)     |          |                            | 7                     | 7                     |
| Number of PLLs                     |          |                            | 1                     | 1                     |
| Number of Macrocells               |          |                            |                       |                       |
| Communication I/F                  |          | I <sup>2</sup> C           | I <sup>2</sup> C/JTAG | I <sup>2</sup> C/JTAG |
| Programming Interface              |          | I <sup>2</sup> C           | I <sup>2</sup> C/JTAG | I <sup>2</sup> C/JTAG |
| Operating Voltage                  |          | 3.3 V                      | 2.8 V to 12 V         | 2.8 V to 12 V         |
| In-system Update Support           |          | ✓                          | ✓                     | ✓                     |
| Temp.                              | I        | ✓                          | ✓                     | ✓                     |
|                                    | AEC-Q100 |                            |                       |                       |
| Package Options                    |          | Digital I/Os               |                       |                       |
| 48-pin QFN (7 x 7 mm)              |          | 9 <sup>5</sup>             |                       |                       |
| 237-Ball ftBGA (1 mm) (17 x 17 mm) |          |                            | 95 + 10 <sup>4</sup>  |                       |
| 100-pin TQFP (14 x 14 mm)          |          |                            |                       |                       |
| 100-Ball caBGA (10 x 10 mm)        |          |                            |                       | 32 + 10 <sup>6</sup>  |
| 48-pin TQFP (7 x 7 mm)             |          |                            |                       |                       |
| 32-pin QFN (5 x 5 mm)              |          |                            |                       |                       |
| 24-pin QFN (4 x 4 mm)              |          |                            |                       |                       |

- 1) POWR1220AT8 provides 6 (5 V Tolerant) digital inputs and 16 (5 V Tolerant) open-drain digital outputs
- 2) POWR1014 & PWOR1014A provide 4 (5 V Tolerant) digital inputs and 12 (5 V Tolerant) open-drain digital outputs
- 3) POWR607 & PWOR605 provide 2 (5 V Tolerant) digital inputs and 5 (5 V Tolerant) open drain I/O
- 4) LPTM21 provides 95 (3.3 V Tolerant) logic I/Os and 10 (5 V Tolerant) open-drain I/O
- 5) 5 V Tolerant open drain I/O
- 6) LPTM21L provides 32 (3.3 V Tolerant) logic I/Os and 10 (5 V Tolerant) open-drain I/O

# IP Cores and Reference Designs

## IP Cores

Lattice IP Cores are pre-tested, reusable functions, that allow designers to focus on their unique system architectures. These IP cores provide industry-standard functions such as PCI Express, DDR, Ethernet, CPRI, and embedded microprocessors. In addition, a number of independent IP providers have teamed with Lattice to offer additional high quality, reusable IP cores. Partners are selected for their industry leadership, high development standards, and commitment to customer support. For a complete listing of IP cores from Lattice and its 3rd party partners, please go to [latticesemi.com/IP](http://latticesemi.com/IP). Note that a Radiant or Diamond Subscription License, and the IP license are required to use the IP for production.

|   | IP Core   | Avant-E | CertusPro-NX | Certus-NX | CrossLink-NX | Mach-NX | MachXO5 | CrossLink | CrossLinkPlus | iCE40 UltraPlus |
|---|---|---------|--------------|-----------|--------------|---------|---------|-----------|---------------|-----------------|
| Communications                                      | 10 Gb Ethernet MAC                                      |         | ✓            |           |              |         |         |           |               |                 |
|   | SGMII and Gb Ethernet PCS                               | ✓       | ✓            | ✓         | ✓            |         | ✓       |           |               |                 |
|   | Triple Speed 10/100/1G Ethernet MAC                     | ✓       | ✓            | ✓         | ✓            |         | ✓       |           |               |                 |
| Connectivity  | 10 Gb Ethernet PCS                                      |         | ✓            |           |              |         |         |           |               |                 |
|   | GPIO  |         | ✓            | ✓         | ✓            |         |         |           |               | ✓               |
|   | PCI Express x1 Endpoint                                 |         | ✓            | ✓         | ✓            |         |         |           |               |                 |
|   | PCI Express x2 Endpoint                                 |         | ✓            |           |              |         |         |           |               |                 |
|   | PCI Express x4 Endpoint                                 |         | ✓            |           |              |         |         |           |               |                 |
|   | PCI Express Root Complex Lite x1                        |         | ✓            | ✓         | ✓            |         |         |           |               |                 |
|   | PCI Express Root Complex Lite x4                        |         | ✓            |           |              |         |         |           |               |                 |
| Digital Signal Processing                           | USB IP Core   |         |              |           | ✓            |         |         |           |               |                 |
|   | CORDIC  | ✓       | ✓            | ✓         | ✓            |         | ✓       |           |               |                 |
|   | Divider   | ✓       | ✓            | ✓         | ✓            |         | ✓       |           |               |                 |
|   | FFT Compiler  | ✓       | ✓            | ✓         | ✓            |         | ✓       |           |               |                 |
| Processor, Controller & Peripheral                  | FIR Filter Generator                                    |         | ✓            | ✓         | ✓            |         | ✓       |           |               |                 |
|   | DDR3 SDRAM Controller                                   |         | ✓            | ✓         | ✓            |         |         |           |               |                 |
|   | DDR3 SDRAM PHY  |         | ✓            | ✓         | ✓            |         |         |           |               |                 |
|   | I <sup>2</sup> C Master                                 | ✓       | ✓            | ✓         | ✓            |         | ✓       |           |               |                 |
|   | I <sup>2</sup> C Slave                                  | ✓       | ✓            | ✓         | ✓            |         | ✓       |           |               |                 |
|   | I <sup>3</sup> C Controller                             |         | ✓            | ✓         | ✓            |         | ✓       |           |               | ✓               |
|   | I <sup>3</sup> C Target                                 |         | ✓            | ✓         | ✓            |         | ✓       |           |               | ✓               |
|   | LPDDR2 SDRAM Controller Lite                            |         | ✓            | ✓         | ✓            |         |         |           |               |                 |
|   | LPDDR4 SDRAM Controller                                 | ✓       | ✓            |           |              |         |         |           |               |                 |
|   | Scatter Gather DMA                                      |         | ✓            | ✓         | ✓            |         | ✓       |           |               |                 |
|   | SPI Master  | ✓       | ✓            | ✓         | ✓            |         | ✓       |           |               |                 |
|   | SPI Slave   | ✓       | ✓            | ✓         | ✓            |         | ✓       |           |               |                 |
|   | UART 16550  | ✓       | ✓            | ✓         | ✓            |         | ✓       |           |               | ✓               |
| Neural Network Accelerators                         | Watchdog Timer  | ✓       | ✓            | ✓         | ✓            |         | ✓       |           |               |                 |
|   | CNN Plus Accelerator                                    |         | ✓            | ✓         | ✓            |         |         |           |               |                 |
| Lattice Propel                                      | Compact CNN Accelerator                                 |         |              |           |              |         |         |           |               | ✓               |
|   | AHB Lite Interconnect Module                            |         |              | ✓         | ✓            | ✓       |         |           |               |                 |
|   | AHB Lite to APB Bridge Module                           |         |              | ✓         | ✓            | ✓       |         |           |               |                 |
|   | APB Interconnect Module                                 |         |              | ✓         | ✓            | ✓       |         |           |               |                 |
|   | I <sup>2</sup> C Master                                 | ✓       | ✓            | ✓         | ✓            |         | ✓       |           |               | ✓               |
|   | I <sup>2</sup> C Slave                                  | ✓       | ✓            | ✓         | ✓            |         | ✓       |           |               | ✓               |
|   | I <sup>3</sup> C Controller                             |         | ✓            | ✓         | ✓            |         | ✓       |           |               | ✓               |
|   | I <sup>3</sup> C Target                                 |         | ✓            | ✓         | ✓            |         | ✓       |           |               | ✓               |
|   | RISC-V MC CPU IP  | ✓       | ✓            | ✓         | ✓            | ✓       | ✓       |           |               |                 |
|   | RISC-V SM CPU IP  |         | ✓            | ✓         | ✓            | ✓       | ✓       |           |               |                 |
|   | SGMII and Gb Ethernet PCS                               | ✓       | ✓            | ✓         | ✓            |         | ✓       |           |               |                 |
| Video & Imaging                                     | System Memory Module                                    |         | ✓            | ✓         | ✓            | ✓       |         |           |               |                 |
|   | UART IP Core  |         |              | ✓         | ✓            | ✓       |         |           |               |                 |
|   | 2D Scaler   |         | ✓            | ✓         | ✓            |         | ✓       |           |               | ✓               |
|   | 4:1 MIPI CSI-2 Bridge                                   |         |              |           |              |         |         | ✓         | ✓             |                 |
|   | Byte to Pixel Converter                                 | ✓       | ✓            | ✓         | ✓            |         | ✓       | ✓         | ✓             |                 |
|   | Color Space Converter                                   | ✓       | ✓            | ✓         | ✓            |         | ✓       |           |               | ✓               |
|   | CMOS to MIPI D-PHY Interface Bridge                     |         |              |           |              |         |         | ✓         |               |                 |
|   | 1:2 and 1:1 MIPI CSI-2 to CSI-2 Camera Interface Bridge |         |              |           |              |         |         | ✓         | ✓             |                 |
|   | MIPI CSI-2 Bridge                                       |         |              |           |              |         |         | ✓         | ✓             |                 |
|   | CSI-2/DSI D-PHY Receiver                                | ✓       | ✓            | ✓         | ✓            |         | ✓       | ✓         | ✓             |                 |
|   | CSI-2/DSI D-PHY Transmitter                             | ✓       | ✓            | ✓         | ✓            |         | ✓       | ✓         | ✓             |                 |
|   | Deinterlacer  |         | ✓            | ✓         | ✓            |         | ✓       |           |               | ✓               |
|   | DSI to DSI  |         |              |           |              |         |         | ✓         | ✓             |                 |
|   | FPD-LINK Receiver                                       |         | ✓            | ✓         | ✓            |         | ✓       | ✓         | ✓             |                 |
|   | FPD-LINK Transmitter                                    |         | ✓            | ✓         | ✓            |         | ✓       | ✓         | ✓             |                 |
|   | Gamma Corrector   | ✓       | ✓            | ✓         | ✓            |         | ✓       |           |               | ✓               |
|   | MIPI D-PHY to CMOS                                      |         |              |           |              |         |         | ✓         | ✓             |                 |
| MIPI DSI Bandwidth Reducer Display Interface Bridge |   |         |              |           |              |         | ✓       | ✓         |               |                 |
| MIPI DSI to OpenLDI/FPD-Link/LVDS                   |   |         |              |           |              |         | ✓       | ✓         |               |                 |
| Pixel to Byte Converter                             | ✓   | ✓       | ✓            | ✓         |              | ✓       |         |           |               |                 |
| SLVS-EC Receiver                                    |   | ✓       |              |           |              |         |         |           |               |                 |
| SubLVDS Image Sensor Receiver                       | ✓   | ✓       | ✓            | ✓         |              | ✓       | ✓       | ✓         |               |                 |
| SubLVDS to MIPI CSI-2                               |   |         |              |           |              |         | ✓       | ✓         |               |                 |
| Image Sensor Interface Bridge                       |   |         |              |           |              |         | ✓       | ✓         |               |                 |
| Video Frame Buffer                                  |   | ✓       | ✓            | ✓         |              |         |         |           |               |                 |

# IP Cores and Reference Designs

|   | IP Core  | ECP5/ECP5-5G     | ECP3 | ECP2M | ECP2 | MachXO2 | MachXO3D | XP2 |
|---|--|------------------|------|-------|------|---------|----------|-----|
| Communications                              | 10 Gb Ethernet MAC                               | ✓                | ✓    | ✓     | ✓    |         |          |     |
|   | 2.5 Gb Ethernet MAC                              |                  | ✓    |       |      |         |          |     |
|   | 2.5 Gb Ethernet PCS                              |                  | ✓    |       |      |         |          |     |
|   | CPRI   | ✓                | ✓    | ✓     |      |         |          |     |
|   | CPRI 5G  | ✓                | ✓    | ✓     |      |         |          |     |
|   | SPI4   | ✓                | ✓    | ✓     |      |         |          |     |
|   | SGMII and Gb Ethernet PCS                        | ✓                | ✓    | ✓     |      | ✓       |          | ✓   |
|   | Triple Speed 10/100/1G Ethernet MAC              | ✓                | ✓    | ✓     |      | ✓       |          | ✓   |
| XAUI  | ✓  | ✓                | ✓    |       |      |         |          |     |
| Connectivity                                | JESD204A   |                  | ✓    |       |      |         |          |     |
|   | JESD204B   | ✓                | ✓    |       |      |         |          |     |
|   | JESD207  | ✓                | ✓    |       |      |         |          |     |
|   | PCI Express x1 Endpoint                          | ✓                | ✓    | ✓     |      |         |          |     |
|   | PCI Express x2 Endpoint                          | ✓                |      |       |      |         |          |     |
|   | PCI Express x4 Endpoint                          | ✓                | ✓    | ✓     |      |         |          |     |
|   | PCI Express Root Complex Lite x1                 | ✓                | ✓    | ✓     |      |         |          |     |
|   | PCI Express Root Complex Lite x4                 | ✓                | ✓    | ✓     |      |         |          |     |
|   | PCI Express x1 Endpoint - Optimized for ECP5UM5G | ✓                |      |       |      |         |          |     |
|   | PCI Express x2 Endpoint - Optimized for ECP5UM5G | ✓                |      |       |      |         |          |     |
|   | PIPE   |                  | ✓    |       |      |         |          |     |
|   | PCI Master/Target 33                             |                  | ✓    | ✓     | ✓    | ✓       | ✓        | ✓   |
|   | PCI Master/Target 66                             |                  | ✓    | ✓     | ✓    | ✓       | ✓        | ✓   |
|   | PCI Target 33                                    |                  | ✓    | ✓     | ✓    | ✓       | ✓        | ✓   |
|   | PCI Target 66                                    |                  | ✓    | ✓     | ✓    | ✓       |          | ✓   |
|   | Serial RapidIO                                   |                  | ✓    |       |      |         |          |     |
| Tri-Rate Serial Digital Interface (SDI) PHY |  | ✓                |      |       |      |         |          |     |
| Digital Signal Processing                   | Block Convolutional Encoder                      |                  | ✓    | ✓     |      |         |          | ✓   |
|   | Block Viterbi Decoder                            |                  | ✓    | ✓     |      |         |          | ✓   |
|   | Cascaded Integrator-Comb (CIC) Filter            |                  | ✓    | ✓     |      |         |          | ✓   |
|   | CORDIC   | ✓                | ✓    | ✓     |      |         |          | ✓   |
|   | Distributed Arithmetic (DA) FIR Filter           |                  | ✓    | ✓     |      |         |          | ✓   |
|   | Divider  |                  | ✓    | ✓     |      |         |          | ✓   |
|   | Dynamic Block Reed-Solomon Decoder               |                  | ✓    | ✓     |      | ✓       |          | ✓   |
|   | FFT Compiler                                     | ✓                | ✓    | ✓     |      |         |          | ✓   |
|   | FIR Filter Generator                             | ✓                | ✓    | ✓     |      |         |          | ✓   |
|   | Interleaver/De-interleaver                       |                  | ✓    | ✓     |      |         |          | ✓   |
|   | Machine Learning for ECP5                        | ✓                |      |       |      |         |          |     |
|   | Median Filter                                    | ✓                |      |       |      |         |          |     |
|   | Numerically-Controlled Oscillator (NCO)          |                  | ✓    | ✓     |      |         |          | ✓   |
|   | Peak Cancellation Crest Factor Reduction (CFR)   | ✓                | ✓    |       |      |         |          |     |
| Processor, Controller & Peripheral          | DDR SDRAM Controller Pipelined                   |                  | ✓    | ✓     | ✓    | ✓       |          | ✓   |
|   | DDR2 SDRAM Controller Pipelined                  |                  | ✓    | ✓     | ✓    | ✓       |          | ✓   |
|   | DDR3 SDRAM Controller                            | ✓                | ✓    |       |      |         |          |     |
|   | DDR3 SDRAM PHY                                   | ✓                | ✓    |       |      |         |          |     |
|   | LPDDR SDRAM Controller                           |                  |      |       |      | ✓       |          |     |
|   | LPDDR2 SDRAM Controller Lite                     | ✓                |      |       |      |         |          |     |
|   | LPDDR3 SDRAM Controller                          | ✓                |      |       |      |         |          |     |
|   | Scatter Gather DMA                               | ✓                | ✓    | ✓     | ✓    |         |          | ✓   |
| Neural Network Accelerators                 | CNN Accelerator                                  | ✓                | ✓    |       |      |         |          |     |
| Lattice Propel                              | AHB Lite Interconnect Module                     |                  |      |       |      | ✓       | ✓        |     |
|   | AHB Lite to APB Bridge Module                    |                  |      |       |      | ✓       | ✓        |     |
|   | APB Interconnect Module                          |                  |      |       |      | ✓       | ✓        |     |
|   | EFB Module                                       |                  |      |       |      |         | ✓        |     |
|   | I <sup>2</sup> C_Monitor                         |                  |      |       |      |         | ✓        |     |
|   | QSPI_Master_Streamer                             |                  |      |       |      |         | ✓        |     |
|   | QSPI_Monitor                                     |                  |      |       |      |         | ✓        |     |
|   | RISC-V MC CPU IP                                 |                  |      |       |      | ✓       | ✓        |     |
|   | RISC-V SM CPU IP                                 |                  |      |       |      | ✓       | ✓        |     |
|   | System Memory Module                             |                  |      |       |      | ✓       | ✓        |     |
|   | UART IP Core                                     |                  |      |       |      | ✓       | ✓        |     |
|   | Video & Imaging                                  | 2D Edge Detector |      | ✓     | ✓    | ✓       |          |     |
| 2D FIR Filter                               |  |                  | ✓    | ✓     | ✓    |         |          | ✓   |
| 2D Scaler                                   |  | ✓                | ✓    | ✓     | ✓    |         |          | ✓   |
| Color Space Converter                       |  | ✓                | ✓    | ✓     | ✓    | ✓       |          | ✓   |
| Deinterlacer                                |  |                  | ✓    | ✓     | ✓    |         |          | ✓   |
| Display Interface Mux                       |  |                  |      |       |      | ✓       |          |     |
| DVB-ASI                                     |  |                  | ✓    |       |      |         |          |     |
| Gamma Corrector                             |  | ✓                | ✓    | ✓     | ✓    |         |          | ✓   |
| Median Filter                               |  |                  | ✓    | ✓     |      |         |          | ✓   |
| Video Frame Buffer                          | ✓  | ✓                | ✓    | ✓     | ✓    |         | ✓        |     |

# IP Cores and Reference Designs

## Reference Designs

Lattice Reference Designs are reusable as-is codes that allow designers to quickly build their unique applications. These reference designs provide functions such as 7:1 LVDS, Barcode Emulation, Sensor Interfacing & Preprocessing, I<sup>2</sup>C, SPI, and MIPI solutions. For a complete listing of reference designs from Lattice, please go to: [www.latticesemi.com/referencedesigns](http://www.latticesemi.com/referencedesigns).

| Name   | Reference Design No. | ECP5/<br>ECP5-5G | Lattice<br>ECP3 | Mach<br>XO3 | Mach<br>XO2 | Lattice<br>XP2 | iCE40<br>LP/HX | iCE40<br>Ultra | iCE40<br>UltraPlus | Format  |      |
|--|----------------------|------------------|-----------------|-------------|-------------|----------------|----------------|----------------|--------------------|---------|------|
|  |                      |                  |                 |             |             |                |                |                |                    | Verilog | VHDL |
| 7:1 LVDS Video Interface   | RD1030               | ✓                | ✓               |             | ✓           | ✓              |                |                |                    | ✓       | ✓    |
| 8:1 Microphone Aggregation   | UG-02035             |                  |                 |             |             |                |                |                | ✓                  |         |      |
| 8b/10b Encoder/Decoder   | RD1012               | ✓                | ✓               | ✓           | ✓           | ✓              |                |                |                    | ✓       | ✓    |
| ADC Interface  | RD1089               |                  | ✓               |             |             |                |                |                |                    | ✓       | ✓    |
| Audio Interface Bridging   | UG-02008             |                  |                 |             |             |                |                |                | ✓                  |         |      |
| BSCAN - Multiple Boundary Scan Port<br>Addressable Buffer (BSCAN1)                       | RD1001               |                  |                 |             | ✓           | ✓              |                |                |                    |         |      |
| BSCAN - Multiple Boundary Scan Port Linker<br>(BSCAN 2)                                  | RD1002               | ✓                |                 |             | ✓           | ✓              |                |                |                    |         |      |
| Controller Area Network (CAN) Controller   | RD1170               |                  |                 |             |             |                | ✓              |                |                    | ✓       |      |
| FPGA Loader  | AN8077               |                  |                 |             | ✓           | ✓              |                |                |                    |         |      |
| GPIO Expander  | RD1065               |                  | ✓               |             |             | ✓              |                |                |                    | ✓       | ✓    |
| Graphics Acceleration  | UG-02026             |                  |                 |             |             |                |                |                | ✓                  |         |      |
| HDMI/DVI Interface   | RD1097               | ✓                | ✓               |             |             |                |                |                |                    | ✓       | ✓    |
| HiSPi-to-Parallel Sensor Bridge  | RD02062              | ✓                | ✓               | ✓           | ✓           | ✓              |                |                |                    | ✓       | ✓    |
| Human Face Identification Using CNN<br>Accelerator IP                                    | RD02062              | ✓                |                 |             |             |                |                |                |                    | ✓       |      |
| Human Presence Detection Using Compact<br>CNN Accelerator IP                             | RD02059              |                  |                 |             |             |                |                |                | ✓                  |         |      |
| I <sup>2</sup> C Bus Controller for Serial EEPROM  | RD1006               | ✓                | ✓               | ✓           | ✓           | ✓              |                |                |                    | ✓       | ✓    |
| I <sup>2</sup> C Master Controller   | RD1005               | ✓                | ✓               | ✓           | ✓           | ✓              |                |                |                    | ✓       | ✓    |
| I <sup>2</sup> C Master Controller   | RD1139               |                  |                 |             |             |                | ✓              |                |                    | ✓       |      |
| I <sup>2</sup> C Master with WISHBONE Controller   | RD1046               | ✓                | ✓               | ✓           | ✓           | ✓              |                |                |                    | ✓       | ✓    |
| I <sup>2</sup> C Slave Controller  | RD1140               |                  |                 |             |             |                | ✓              |                |                    | ✓       |      |
| I <sup>2</sup> C Slave Peripheral Using Embedded Function<br>Block - WISHBONE Compatible | RD1124               |                  |                 | ✓           | ✓           |                |                |                |                    | ✓       | ✓    |
| I <sup>2</sup> C Slave to SPI Master Bridge  | RD1094               |                  |                 |             |             |                |                |                |                    | ✓       | ✓    |
| I <sup>2</sup> C Slave/Peripheral  | RD1054               | ✓                | ✓               |             |             | ✓              |                |                |                    | ✓       | ✓    |
| I <sup>2</sup> C to SPI Bridge   | RD1172               |                  |                 |             |             |                | ✓              |                |                    | ✓       | ✓    |
| I <sup>2</sup> S Controller  | RD1101               |                  |                 | ✓           | ✓           |                |                |                |                    | ✓       | ✓    |
| I <sup>2</sup> S Controller  | RD1171               |                  |                 |             |             |                | ✓              |                |                    | ✓       | ✓    |
| iCE40 Ultra Barcode Emulation Reference Design   | UG73                 |                  |                 |             |             |                |                | ✓              | ✓                  | ✓       |      |
| iCE40 Ultra Pedometer  | UG76                 |                  |                 |             |             |                |                | ✓              | ✓                  | ✓       |      |
| iCE40 Ultra RGB LED Controller   | UG75                 |                  |                 |             |             |                |                | ✓              | ✓                  | ✓       |      |
| iCE40 Ultra Self-Learning IR Remote  | UG74                 |                  |                 |             |             |                |                | ✓              | ✓                  | ✓       |      |
| Key Phrase Detection Using Compact CNN<br>Accelerator                                    | RD02066              |                  |                 |             |             |                |                |                | ✓                  | ✓       |      |
| Keypad Scanner   | RD1180               |                  |                 |             |             |                | ✓              |                |                    |         | ✓    |
| LatticeMico32 - Embedded Processor -<br>WISHBONE Compatible                              |                      | ✓                | ✓               | ✓           | ✓           | ✓              |                |                |                    | ✓       | ✓    |
| LatticeMico8 - Embedded Processor -<br>WISHBONE Compatible                               |                      | ✓                | ✓               | ✓           | ✓           | ✓              |                |                |                    | ✓       | ✓    |
| LatticeMico8 Microcontroller User's Guide  | RD1026               |                  |                 | ✓           | ✓           | ✓              |                |                |                    | ✓       | ✓    |
| LatticeMico8 to WISHBONE Interface Adapter   | RD1043               |                  |                 |             |             | ✓              |                |                |                    | ✓       | ✓    |
| LED/OLED Driver  | RD1103               |                  |                 | ✓           | ✓           |                |                |                |                    | ✓       |      |
| LPC Bus Controller   | RD1049               |                  | ✓               |             | ✓           | ✓              |                |                |                    | ✓       | ✓    |
| MachXO2 Display Interface  | RD1093               |                  |                 |             | ✓           |                |                |                |                    | ✓       | ✓    |
| MachXO2 I <sup>2</sup> C Embedded Programming Access<br>Firmware - WISHBONE Compatible   | RD1129               |                  |                 |             | ✓           |                |                |                |                    | ✓       |      |
| MachXO2 Soft I <sup>2</sup> C Slave<br>with Clock Stretching - WISHBONE Compatible       | RD1186               |                  |                 |             | ✓           |                |                |                |                    | ✓       |      |
| MDIO Peripheral - WISHBONE Compatible  | RD1074               |                  | ✓               |             |             |                |                |                |                    | ✓       | ✓    |
| MIPI CSI-2-to-CMOS Parallel Sensor Bridge  | RD1146               |                  |                 | ✓           | ✓           |                |                |                |                    | ✓       |      |
| MIPI DPHY Interface IP   | RD1182               | ✓                | ✓               | ✓           | ✓           |                |                |                |                    | ✓       |      |
| MIPI DSI RX to Parallel Bridge   | RD1185               |                  |                 | ✓           | ✓           |                |                |                |                    | ✓       |      |

Continued on next page



# IP Cores and Reference Designs

| Name  | Reference Design No. | CertusPro-NX | CrossLink | ECP5/<br>ECP5-5G | Lattice<br>ECP3 | Mach<br>XO3/<br>D | Mach<br>XO2 | Mach<br>XO5 | Lattice<br>XP2 | iCE40<br>LP/HX | iCE40<br>Ultra | iCE40<br>UltraPlus | Format  |      |   |
|---|----------------------|--------------|-----------|------------------|-----------------|-------------------|-------------|-------------|----------------|----------------|----------------|--------------------|---------|------|---|
|   |                      |              |           |                  |                 |                   |             |             |                |                |                |                    | Verilog | VHDL |   |
| MxN Channel PWM   | RD1175               |              |           |                  |                 |                   |             |             |                | ✓              |                |                    |         | ✓    |   |
| NAND Flash Controller   | RD1055               |              |           |                  |                 |                   | ✓           |             | ✓              |                |                |                    |         | ✓    | ✓ |
| Object Counting Using<br>CNN Accelerator IP   | FPGA-RD-02058        |              |           | ✓                |                 |                   |             |             |                |                |                |                    |         | ✓    |   |
| Object Counting Using<br>CNN Plus Accelerator IP                                      | FPGA-RD-02200        |              | ✓         |                  |                 |                   |             |             |                |                |                |                    |         |      |   |
| Panasonic Area Sensor-<br>to-Parallel Bridge  | RD1121               |              |           |                  |                 |                   | ✓           |             | ✓              |                |                |                    |         | ✓    |   |
| Parallel to MIPI CSI-2 TX<br>Bridge   | RD1183               |              |           |                  |                 | ✓                 | ✓           |             |                |                |                |                    |         | ✓    |   |
| Parallel to MIPI DSI TX<br>Bridge   | RD1184               |              |           |                  |                 | ✓                 | ✓           |             |                |                |                |                    |         | ✓    |   |
| PCI Target 32 bit/33 MHz  | RD1008               |              |           |                  | ✓               |                   | ✓           |             | ✓              |                |                |                    |         | ✓    | ✓ |
| PCI/WISHBONE Bridge –<br>WISHBONE Compatible  | RD1045               |              |           |                  | ✓               |                   |             |             | ✓              |                |                |                    |         | ✓    | ✓ |
| PWM Fan Controller –<br>WISHBONE Compatible   | RD1060               |              |           |                  |                 | ✓                 | ✓           |             | ✓              |                |                |                    |         | ✓    | ✓ |
| PWM Generator   | RD1178               |              |           |                  |                 |                   |             |             |                | ✓              |                |                    |         |      | ✓ |
| RAM-Type Interface<br>for Embedded User<br>Flash Memory -<br>WISHBONE<br>Compatible   | RD1126               |              |           |                  |                 |                   | ✓           |             |                |                |                |                    |         |      |   |
| RC4 Based PRNG<br>Generator   | RD1179               |              |           |                  |                 |                   |             |             |                | ✓              |                |                    |         |      | ✓ |
| Read and Write Usercode   | RD1041               |              |           |                  |                 | ✓                 | ✓           |             |                |                |                |                    |         | ✓    | ✓ |
| RGMII to GMII Bridge  | RD1022               |              |           | ✓                | ✓               |                   |             | ✓           |                |                |                |                    |         | ✓    | ✓ |
| Sensor Data Buffer  | UG-02011             |              |           |                  |                 |                   |             |             |                |                |                | ✓                  |         |      |   |
| SD Flash Controller –<br>WISHBONE Compatible  | RD1048               |              |           |                  |                 |                   |             |             | ✓              |                |                |                    |         | ✓    | ✓ |
| SD Host Controller  | RD1165               |              |           |                  |                 |                   |             |             |                | ✓              |                |                    |         | ✓    | ✓ |
| SDR SDRAM Controller  | RD1174               |              |           |                  |                 | ✓                 |             |             |                | ✓              |                |                    |         | ✓    |   |
| SDR SDRAM Controller –<br>Advanced  | RD1010               |              |           | ✓                | ✓               |                   | ✓           |             | ✓              |                |                |                    |         | ✓    | ✓ |
| Simple Sigma-Delta ADC  | RD1066               |              |           |                  |                 |                   | ✓           |             | ✓              |                |                |                    |         | ✓    | ✓ |
| SMPTE SDI Dual HD<br>from/to 3G Level-B<br>Converter                                  | RD1132               |              |           |                  | ✓               |                   |             |             |                |                |                |                    |         | ✓    |   |
| SPI Master Controller   | RD1141               |              |           |                  |                 |                   |             |             |                | ✓              |                |                    |         | ✓    |   |
| SPI Peripheral  | RD1075               |              |           |                  |                 |                   |             |             |                |                |                |                    |         | ✓    | ✓ |
| SPI Slave Controller  | RD1142               |              |           |                  |                 |                   |             |             |                | ✓              |                |                    |         | ✓    | ✓ |
| SPI Slave Peripheral<br>Using the Embedded<br>Function Block -<br>WISHBONE Compatible | RD1125               |              |           |                  |                 | ✓                 | ✓           |             |                |                |                |                    |         | ✓    | ✓ |
| SPI Slave Port Expander   | RD1168               |              |           |                  |                 |                   |             |             |                | ✓              |                |                    |         |      | ✓ |
| SPI to I <sup>2</sup> C Bridge  | RD1173               |              |           |                  |                 |                   |             |             |                | ✓              |                |                    |         | ✓    |   |
| SPI to MIPI-DSI Bridge  | UG-02059             |              |           |                  |                 |                   |             |             |                |                |                | ✓                  |         |      |   |
| SPI to UART Expander  | RD1143               |              |           |                  |                 |                   |             |             |                | ✓              |                |                    |         |      | ✓ |
| SPI Wishbone Compatible   | RD1044               |              |           |                  |                 | ✓                 | ✓           |             | ✓              |                |                |                    |         | ✓    | ✓ |
| Sub-LVDS Serial to<br>CMOS Parallel Sensor<br>Bridge                                  | RD1130               |              |           |                  |                 |                   | ✓           |             |                |                |                |                    |         | ✓    |   |
| Sub-LVDS-to-Parallel<br>Sensor Bridge   | RD1122               |              |           | ✓                | ✓               |                   | ✓           |             | ✓              |                |                |                    |         | ✓    | ✓ |
| UART - WISHBONE<br>Compatible   | RD1042               |              |           |                  |                 | ✓                 | ✓           |             | ✓              |                |                |                    |         | ✓    | ✓ |
| UART (Universal<br>Asynchronous<br>Receiver/Transmitter)                              | RD1011               |              |           |                  |                 |                   |             | ✓           | ✓              |                |                |                    |         |      | ✓ |
| UART 16550 Transceiver  | RD1138               |              |           |                  |                 |                   |             |             |                | ✓              |                |                    |         | ✓    |   |
| LVDS Tunneling Protocol<br>and Interface Reference<br>Design                          | FPGA-RD-02247        |              |           |                  |                 | ✓                 |             |             |                |                |                |                    |         |      | ✓ |
| 10 Gb Ethernet for MAC &<br>PCS Reference Design<br>Updates                           | FPGA-RD-02248        | ✓            |           |                  |                 |                   |             |             |                |                |                |                    |         | ✓    |   |
| SLVS-EC Sensor to PCIe<br>Bridge Reference Design                                     | FPGA-RD-02261        | ✓            |           |                  |                 |                   |             |             |                |                |                |                    |         |      | ✓ |
| Barcode Detection<br>Reference Design –<br>CertusPro                                  | FPGA-RD-02266        | ✓            |           |                  |                 |                   |             |             |                |                |                |                    |         |      | ✓ |
| I <sup>2</sup> C to APB Bridge<br>Reference Design                                    | FPGA-RD-02263        |              |           |                  |                 | ✓                 | ✓           |             |                |                |                |                    |         | ✓    |   |

## IP Cores and Reference Designs

Lattice Reference Designs are reusable as-is codes that allow designers to quickly build their unique applications. These reference designs provide functions such as I<sup>2</sup>C, SPI, BSCAN and LPC Bus Controller interface solutions. For a complete listing of reference designs from Lattice, please go to: [www.latticesemi.com/referencedesigns](http://www.latticesemi.com/referencedesigns).

### Hardware Management Reference Designs

| Name  | Reference Design No. | MachXO2/3 L | LatticeXP/XP 2/SC/SC/M/EC | ispMACH 4000ZE/V/B/C /Z | ECP/2/2M/3/5 | PLATFORM MANAGER/ 2 | Format |         |
|---|----------------------|-------------|---------------------------|-------------------------|--------------|---------------------|--------|---------|
|   |                      |             |                           |                         |              |                     | VHDL   | Verilog |
| BSCAN - Multiple Boundary Scan Port Addressable Buffer (BSCAN1) | FPGA-RD-02105        | ✓           | ✓                         | ✓                       |              | ✓                   | ✓      | ✓       |
| BSCAN - Multiple Boundary Scan Port Linker (BSCAN 2)            | FPGA-RD-02106        | ✓           | ✓                         | ✓                       | ✓            | ✓                   | ✓      | ✓       |
| FPGA Loader   | FPGA-AN-02014        | ✓           | ✓                         |                         | ✓            |                     | ✓      | ✓       |
| I <sup>2</sup> C Slave Peripheral Using Embedded Function Block | FPGA-RD-02073        | ✓           |                           |                         |              |                     | ✓      | ✓       |
| LPC Bus Controller  | FPGA-RD-02114        | ✓           | ✓                         | ✓                       |              |                     | ✓      | ✓       |
| MachXO2 I <sup>2</sup> C Embedded Programming Access Firmware   | FPGA-RD-02091        | ✓           |                           |                         |              |                     | ✓      | ✓       |
| MachXO2 Soft I <sup>2</sup> C Slave with Clock Stretching       | FPGA-RD-02092        | ✓           |                           |                         |              |                     | ✓      | ✓       |
| NAND Flash Controller   | FPGA-RD-02095        | ✓           | ✓                         |                         |              |                     | ✓      | ✓       |
| RAM-Type Interface for Embedded User Flash Memory               | FPGA-RD-02098        | ✓           |                           |                         |              |                     | ✓      | ✓       |

## iCE40 UltraPlus Single-Wire Signal Aggregation Board

Enables designers to evaluate their single-wire interface to a prototype system to demonstrate a proof of concept in-system.



### Features

- No FPGA tools knowledge necessary
- Customizable via available Reference Design
- Up to 7 channels can be aggregated
- Each channel can be either I2C, I2S or GPIO
- Board set can be configured as a stand-alone demo or in-system proof of concept

### Ordering Part Number

ICE40UP5K-SWA-EVN

## iCE40 UltraPlus Mobile Development Platform

Enables designers to evaluate key connectivity features of the iCE40 UltraPlus FPGA as well as processing features utilizing multiple DSPs, integrated RAM, and FPGA fabric.

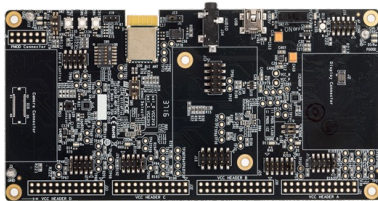

### Features

- x1 MIPI DSI interface up to 108 Mbps
- 4x Microphone bridging (2x I2S mics and 2x PDM mics)
- Compass sensor (LSM303), pressure sensor (BMP180), gyro sensor (LSM330), and accelerometer (LIS2D12)
- 640 x 480 Image sensor (OVM7692)
- BLE module to transfer any captured data from iCE40 UltraPlus wirelessly
- iCE40 UltraPlus can be programmed via on-board SPI Flash or via USB port

### Ordering Part Number

ICE40UP5K-MDP-EVN

## iCE40 UltraPlus Breakout Board

Enables designers to evaluate key connectivity features of the iCE40 UltraPlus FPGA. The breakout board brings out all I/O and allows the FPGA to be programmed over a USB connector.

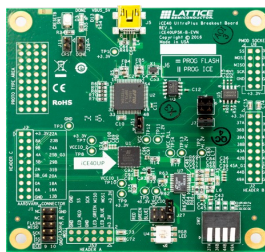

### Features

- iCE40 UltraPlus (iCE40UP5K) device in a 48-pin QFN package
- High-current LED output
- iCE40UP5K application based current measurements
- Standard USB cable for device programming
- RoHS-compliant packaging and process
- Pre-loaded RGB LED Demo
- Software run GUI
- USB Connector Cable

### Ordering Part Number

ICE40UP5K-B-EVN

## iCE40-HX8K Breakout Board

A simple, low-cost board with an iCE40-HX8K FPGA, and generous I/O access.

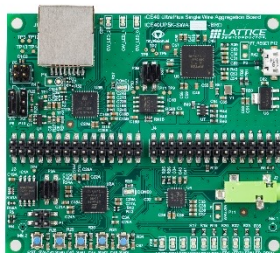

### Features

- No FPGA tools knowledge necessary
- Customizable via available Reference Design
- Up to 7 channels can be aggregated
- Each channel can be either I2C, I2S or GPIO
- Board set can be configured as a stand-alone demo or in-system proof of concept

### Ordering Part Number

ICE40UP5K-SWA-EVN

# Development Kits

## iCE40 Ultra Breakout Board

Featuring an ultra-small FPGA optimized for mobile applications. Typical mobile interfaces like RGB, IR and high current Torch LEDs are included, as well as access to every device I/O.

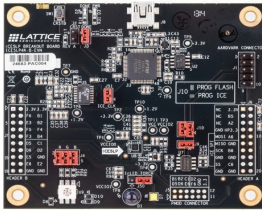

### Features

- iCE5LP4K FPGA in 0.35 mm pitch, 36-ball WLCSP
- RGB LED
- High-brightness “torch” LED
- Infrared (IR) LED
- Status LEDs
- Access to all device I/O
- On-board 32 Mbit SPI Flash for reconfiguration
- Windows- & Mac-based GUI for interface to the RGB LED, includes FPGA source code
- USB Type-A to Type-B (mini) cable for FPGA power and programming via PC

**Ordering Part Number**  
iCE5LP4K-B-EVN

## iCE40 UltraLite Breakout Board

Featuring the world's smallest FPGA optimized for mobile applications. Typical mobile interfaces like RGB, IR and high current Torch LEDs are included, as well as access to every device I/O.

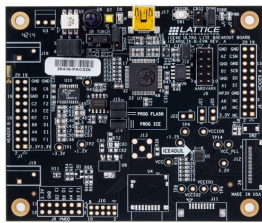

### Features

- iCE40UL1K (iCE401K-CM36A) device in a 36-ball BGA package
- Layout example of a board using 0.40 mm pitch BGA package
- High current LED output
- Infrared transmit capability for remote control functions
- iCE40UL1K application-based current measurements
- Standard USB cable for device programming
- RoHS-compliant packaging and process
- Preloaded RGB LED Demo
- Software-run GUI
- USB connector cable

**Ordering Part Number**  
iCE40UL1K-B-EVN

## iCE40 Ultra Wearable Development Platform

Peripheral and sensor-rich development platform with iCE40 Ultra and MachXO2 in a wearable watch form factor.

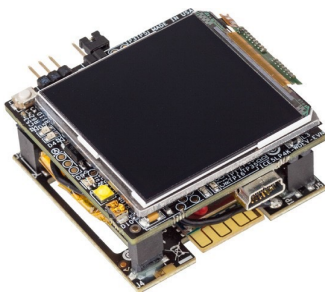

### Features

- Approximately (WxLxH) 1.50" x 1.57" x 0.87" form factor with wrist strap
- iCE40 Ultra iCE5LP4K and MachXO2 LCMXO2-2000ZE
- LG 1.54" 240 x 240 single-lane MIPI DSI display
- Bluetooth low-energy module
- Sensors: Heart-rate/SpO2, skin temperature, pressure and accelerometer/ gyroscope
- 2 user LEDs, RGB LEDs, high-current white LED and high-current IR LED
- Stereo MEMs PDM microphones
- 32 Mbit Quad SPI-flash
- 27 MHz Oscillator
- FTDI 2232HQ USB device allows programming of FPGA and Flash
- Reference design available for download:
  - Parallel RGB to MIPI DIS bridging
  - Health monitoring\*
  - Pedometer\*
  - IR transmitter\*
  - Flashlight\*

\* Reference Android APK available to interface with mobile phone over Bluetooth

**Ordering Part Number**  
iCE40UP5K-B-EVN

## iCE40LP1K Evaluation Kit

Featuring our ultra-small FPGA – 1k LUTs in a 16-ball WLCSP package (0.35 mm- ball pitch), only 1.4 mm x 1.48 mm, RGB LED control, GUI available for PC or Mac interface.



### Features

- iCE40LP1K in 16-WLCSP package (0.35 mm-ball pitch)
- High current tri-color LED (RGB)
- Infrared transmit LED
- Barcode emulation LED
- 27 MHz on-board oscillator
- SMA connector for external clock input
- SPI configuration Flash
- USB Type-A to Type-B (mini) cable for
- FPGA power and programming via PC

**Ordering Part Number**  
iCE40LP1K-SWG16-EVN

# Development Kits

iCE40

## Himax HM01B0 UPduino Shield

A complete development kit for implementing Artificial Intelligence (AI) using the iCE40 UltraPlus with vision and sound as sensory inputs.



### Features

- Lattice UltraPlus FPGA with 5.3K LUTs,
- 1 Mb SPRAM, 120 kb DPRAM, 8 Multipliers
- FTDI FT232HL USB to SPI Device for FPGA programming
- 12 MHz Crystal Oscillator Clock Source
- 34 GPIO on 0.1" headers for connecting to the adapter board
- SPI Flash, RGB LED, 3.3 V and 1.2 V voltage regulators

- HM01B0 low power image sensor supports 30 fps at 1.1 mW
- 2 I2S microphones
- Debug LEDs

### Ordering Part Number

HM01B0-UPD-EVN

CrossLink

## CrossLink LIF-MD6000 Master Link Board

Enables designers to streamline the development process and evaluate key connectivity features of the CrossLink FPGA.

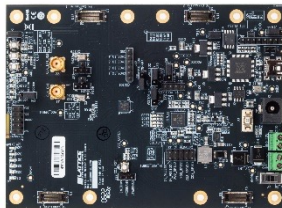

### Features

- Contains the Lattice CrossLink
- LIF-MD6000 in 81-ball csfBGA package
- Contains four connectors for interfacing to MIPI D-PHY and high speed programmable I/O
- Includes 0.1" header board, SMA board and LEDs for interfacing and control
- Provides easy programming interface via USB with FTDI device

### Ordering Part Number

LIF-MD6000-ML-EVN

## CrossLink LIF-MD6000 I/O Link Boards

Allows designers to easily interface to the LIF-MD6000 Master Link Board from a variety of signal sources and sinks using standard SMA connectors.

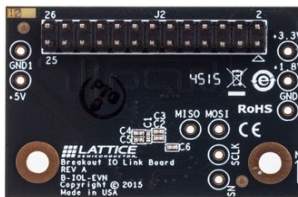

### Features

- I/O Link Boards for use with Lattice LIF-MD6000 Master Link Board for SMA or low speed peripheral connections
- Contains one SMA board and one 0.1" header board

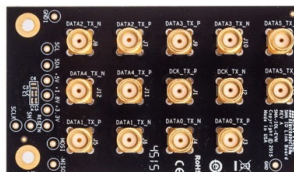

### Ordering Part Number

iCE40UP5K-B-EVN

CrossLink-NX

## CrossLink-NX Evaluation Board

Prototyping Board with Abundant I/O, PCIe 5G SERDES, Expansion Headers and 40k Logic Cells.

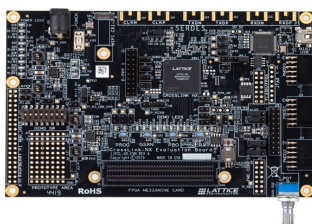

### Features

- CrossLink-NX FPGA (LIFCL-40-9BG400C)
- More I/O access: 118 wide range I/O, 37 high-speed differential pair I/O, one PCIe 5G SERDES channel and most configuration pins accessible
- Expandable usability: FPGA Mezzanine Card (FMC), Raspberry Pi, Digilent Peripheral Module (Pmod™), MIPI CSI-2, D-PHY and general purpose I/O expansion headers
- USB-B connection for device programming and Inter-Integrated Circuit (I2C) utility

- On-board Boot Flash: 128 Mbit Serial Peripheral Interface (SPI) Flash, with Quad read feature
- 8 input DIP switches, 4 push buttons, 3 Status LEDs and 14 LEDs for demo purposes
- Multiple reference clock sources

### Ordering Part Number

LIFCL-40-EVN

## CrossLink-NX PCIe Bridge Board

Enables designers to quickly and efficiently develop designs to bridge a multitude of industry interface I/O standards to PCIe.

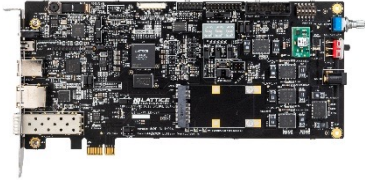

### Features

- CrossLink-NX FPGA (LIFCL-40-8BG400C/ES2)
- PCIe x1 Gen2 supports the Endpoint and Root port configuration
- Supports 1 SFP port on SGMII and 1 Gbit DDR3 Memory
- USB-B connection for device programming and Inter-Integrated Circuit (I2C) utility
- One RJ45 on Ethernet RGMII PHY
- Variable potentiometer and Header for ADC

- Onboard Boot Flash – 512 Mbit Serial Peripheral Interface (SPI) Flash with Quad mode support
- Multiple reference clock sources

### Ordering Part Number

LIFCL-PCIEB-EVN

## CrossLink-NX Voice and Vision Machine Learning Board

CrossLink™-NX FPGA board is ideal for machine learning applications and features onboard HyperRAM as well as PMOD (Peripheral Module) connectors for off board support.

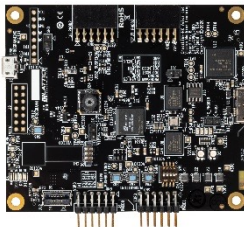

### Features

- CrossLink-NX FPGA (LIFCL-40-MG289)
- Contains 4-lane MIPI CSI-2 receiver interface for high resolution camera data
- Supports I2S interface for audio data from two microphones
- Serial interface for low resolution camera data
- SPI flash configuration
- General Purpose Input/Output

- With 2\*64 Mb HyperRAM available for ML (Machine Learning) applications
- Cypress CYUSB3014 for Video Output to PC over USB3
- 4 PMOD connectors expansion headers available

### Ordering Part Number

LIFCL-VVML-EVN

## CrossLink-NX-33 Voice and Vision Machine Learning Board

Designed with low power machine learning applications in mind, using Crosslink-NX 33K, a powerful FPGA with an AI accelerator.

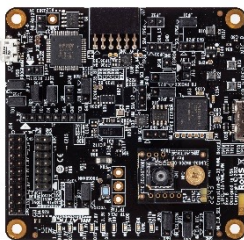

### Features

- CrossLink-NX-33 FPGA (LIFCL-33-USG84)
- MIPI CSI-2 receiver (Soft D-PHY) interface for high resolution camera data
- Support I2S interface for audio data from two microphones
- SPI flash configuration
- General Purpose Input/Output
- Programming software through USB/FTDI interface (JTAG or SPI)

- Cypress CYUSB3014 for Video Output to PC over USB3
- 1 PMOD connector expansion header available

### Ordering Part Number

LIFCL-33-VVML-EVN

## CrossLinkU-NX Evaluation Board

CrossLinkU-NX Evaluation Board key component is the LIFCL-33U FPGA, which receives input from a camera and sends video output over LIFCL-33U's USB 3.2 interface. This board also features two PMOD (Peripheral Module) connectors for off board support.

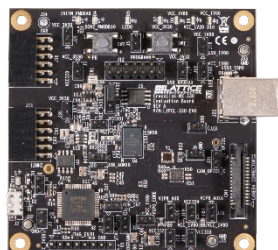

### Features

- CrossLinkU-NX FPGA (LIFCL-33U-CTG104)
- Support MIPI CSI-2 receiver (Soft D-PHY) interface for camera data
- SPI flash configuration, 128 Mb QSPI
- Two PMOD expansion headers available and 256 Mb PSRAM Memory
- Supports various onboard interfaces and external interfaces
- Programmed with USB through the FTDI/JTAG interface using Lattice Radiant™ programmer software, or by an external SPI Programmer through header

### Ordering Part Number

LIFCL-33U-EVN

## CrossLink-NX VIP Sensor Input Board

CrossLink-NX VIP Sensor Input Board, expands multi-sensor connectivity and processing to the Embedded Vision Development Kit..

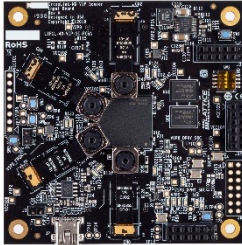

### Features

- Four on-board Sony IMX 256 image sensors
- Three PMOD connectors for flexible sensor connectivity
- Contains the Lattice CrossLink-NX
- Optimized for easy sensor aggregation
- Supports 4K/2K @60 fps or 1080p @60 fps
- Complements Embedded Vision Development Kit by providing for fast prototyping

### Ordering Part Number

LIFCL-VIP-SI-EVN

## DisplayPort VIP Input Board

DisplayPort VIP Input Board, expands video connectivity to the Embedded Vision Development Kit with the inclusion of DisplayPort RX and embedded DisplayPort RX.

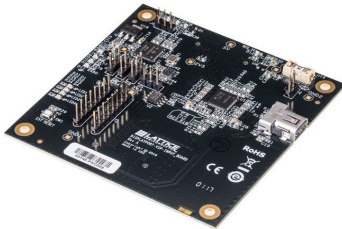

### Features

- Supports DisplayPort 1.4 up to 2.7 Gbps
- Integrated Texas Instruments SN75DP130 DisplayPort 1:1 Redriver
- Mini DisplayPort (mDP) connector
- Two 60-pin rugged high-speed headers
- Modular Video Interface Platform (VIP) with eDP RX feature support
- Develop custom video interface solutions for embedded vision and machine learning using Lattice Diamond Software

### Ordering Part Number

DP-VIP-I-EVN

## DisplayPort VIP Output Board

DisplayPort VIP Input Board, expands video connectivity to the Embedded Vision Development Kit with the inclusion of DisplayPort TX and embedded DisplayPort TX.

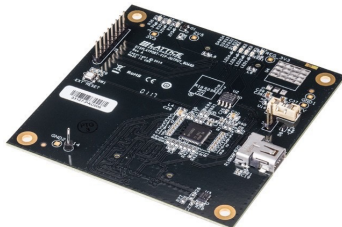

### Features

- Supports DisplayPort 1.4 up to 2.7 Gbps
- Integrated Texas Instruments SN75DP130 DisplayPort 1:1 Redriver
- Mini DisplayPort (mDP) connector
- Two 60-pin rugged high-speed headers
- Modular Video Interface Platform (VIP) with eDP TX feature support
- Develop custom video interface solutions for embedded vision and machine learning using Lattice Diamond Software

### Ordering Part Number

DP-VIP-O-EVN

## Embedded Vision Development Kit

Embedded Vision Development Kit with dual-camera to HDMI bridging, features CrossLink, ECP5 and SiI1136 devices. The kit's modular platform simplifies development and offers flexibility for design expansion.

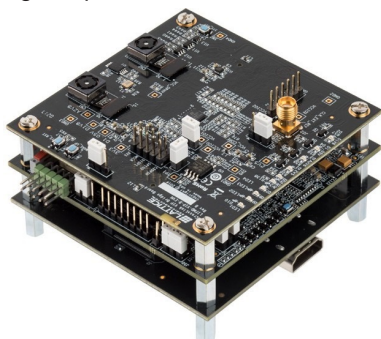

### Features

- All-inclusive demo system with on-board video sources
- CrossLink LIF-MD6000 input board with two Sony IMX 214 high-speed MIPI D-PHY interface camera sensors
- ECP5 processor board with pre-loaded high-definition Image Signal Processing IP (HD ISP)
- SiI1136, non-HDCP, output board connects any HDMI

- Includes 0.1" header prototyping
- Easy programming interface via USB with FTDI device
- Modular Video Interface Platform (VIP) allows mixing and matching of input and output boards
- Develop custom video interface solutions for embedded vision and machine learning using Lattice Diamond Software

### Ordering Part Number

LF-EVDK1-EVN

## USB3-GbE VIP IO Board

USB3-GbE VIP IO Board provides USB 3.1 and Gigabit Ethernet connectivity by converting the output of the ECP5 VIP Processor Board into a standard USB 3.1 and Gigabit Ethernet interface.



### Features

- Two Unified 60-pin high speed connectors
- On board Cypress FX3 USB 3.1 controller
- Compliant with USB 3.1 specification revision 1.0
- Supports standard USB 3.0 interface
- On board industrial grade TI DP83867IR Gigabit Ethernet PHY
- Supports 10/100/1000 Ethernet

### Ordering Part Number

USB3-VIP-EVN

## Machine Learning Adapter Card

The Machine Learning Adapter Card adds external memory and microphone input to the ECP5 VIP Processor Board.

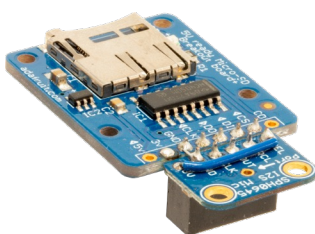

### Features

- Includes 8 GB MicroSD card
- Includes Microphone Input
- Easy connection to ECP5 VIP Processor Board, included in Embedded Vision Development Kit

### Ordering Part Number

ML-ADP-EVN

## HDMI VIP Input Bridge Board

The HDMI VIP Input Bridge Board complements the Embedded Vision Development Kit by providing two selectable HDMI input signals for fast prototyping. The board converts two unencrypted HDMI input video signals into a parallel RGB video format.

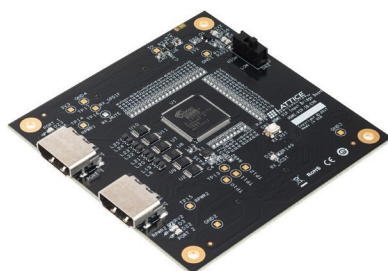

### Features

- 2 switchable HDMI input signal
- Contains the Lattice Si1127A
- Transfer of non-HDCP input data
- Support of 1080p @ 60 Hz HDMI-compliant digital audio and video
- Can be used as stand-alone board or combined with the Embedded Vision Development Kit

### Ordering Part Number

HDMI-VIP-IB-EVN

## Lattice USB 3.0 Video Bridge Development Kit

This is a production-ready, high-definition video capture and conversion system, based on the LatticeECP3™ FPGA family.



### Features

- Production-ready USB 3.0 audio/video bridging reference design
- 1080p video streaming over USB 3.0 @60 fps
- HDMI 1.4a audio and video capture
- SD-, HD-, 3G-SDI audio and video capture
- Supports video capture from external MIPI CSI-2, SubLVDS or Parallel sensors
- Reference design provides fast USB 3.0 UVC and UAC class data packing
- Plug and play operations as a video capture device on multiple standard platforms (Windows, MacOS, Linux)
- Complete reference design schematics and documentation available

### Ordering Part Number

HDMI-VIP-IB-EVN



## Lattice Sentry Demo Boards for MachXO3D and Mach-NX

The Lattice Sentry Demo Board for MachXO3D or Mach-NX lets you develop, demonstrate and test a NIST 800-193-compliant PFR solution on a single board, using the MachXO3D LCMXO3D-9400HC-6BG484C, or Mach-NX LFMNX-50FBG484C as a Platform Root of Trust, and two Lattice ECP5 FPGAs which act as PFR-protected ICs in the system.

### Features

- MachXO3D LCMXO3D-9400HC-6BG484C  
or  
Mach-NX FPGA - LFMNX-50FBG484C
- Power Supply (12 V)
- Lattice Sentry Solution Stack PFR demo support

- Lattice Sentry system-level behavior validation
- USB connection for device programming
- Two ECP5 FPGA devices on-board with 256 M SPI/QSPI flash devices to simulate protected external devices

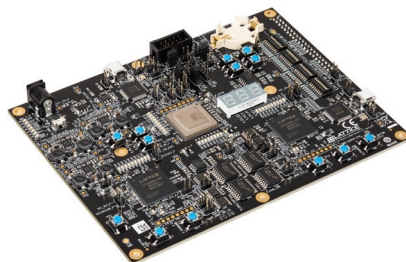
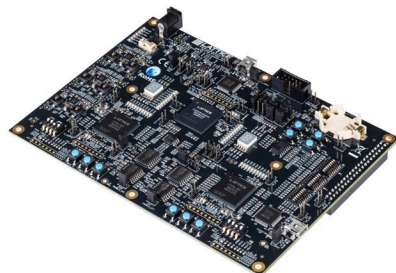

### Ordering Part Number

|                  |
|------------------|
| LCMXO3D-PFR-EVN  |
| LFMNX-SENTRY-EVN |

## MachXO3L / MachXO3LF Starter Kit

The MachXO3L(F) Starter Kit is a basic breakout board to allow simple evaluation and development of MachXO3L(F) based designs. It includes the LCMXO3L(F)-6900C-5BG256C device.

### Features

- MachXO3L FPGA – LCMXO3L(F)-6900C-5BG256C
- USB Type-B (mini) connector (program/power)
- Pre-programmed example design (available on [latticesemi.com](http://latticesemi.com))
- Eight LEDs
- 4-position DIP switch

- 40-hole prototyping area
- Four 2 x 20 expansion header landings for general I/O, JTAG and external power
- 1 x 8 expansion header landing for JTAG
- 1 x 6 expansion header landing for SPI/ I<sup>2</sup>C
- SPI Flash for external boot or dual boot
- 3.3 V and 1.2 V supply rails

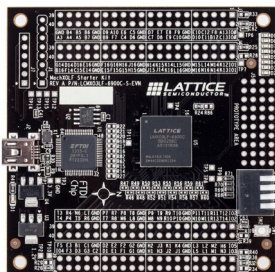

### Ordering Part Number

|                      |
|----------------------|
| LCMXO3L-6900C-S-EVN  |
| LCMXO3LF-6900C-S-EVN |

## MachXO3L Breakout Board

Focusing on evaluating high-speed source synchronous interfaces with the Lattice MachXO3L-2100 and MachXO3L-6900 products in both 49-ball WLCSP and 256-ball caBGA packages respectively.

### Features

- Two MachXO3L FPGAs
  - XO3L-6900E in 256caBGA
  - XO3L-2100E in 49WLCSP
- Two optional configurations:
  - 50-pin Harwin Archer connector for interface to DSI screen (screen not included)
  - 40 SMA connectors for LVDS I/O evaluation
- Generous prototyping/breakout access
- Switches and LEDs for user input and feedback

- Discrete resistors to support SLVS, subLVDS or DPHY Tx, and DPHY Rx, LP mode
- USB Type-A to Type-B (mini) cable for FPGA power and programming via PC
- DC jack for supplemental power input

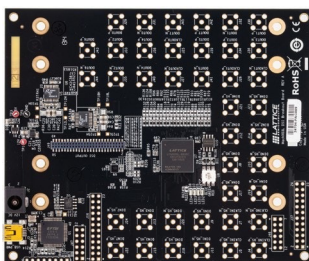

### Ordering Part Number

|                       |                 |
|-----------------------|-----------------|
| MachXO3L SMA Breakout | LCMXO3L-SMA-EVN |
| MachXO3L DSI Breakout | LCMXO3L-DSI-EVN |

# Development Kits

## MachXO3-9400 Development Board

The MachXO3-9400 Development Board is a full-featured board allowing the evaluation of MachXO3 in hardware management with L-ASC10 and I/O expansion applications utilizing the on-board connectors for Arduino and Raspberry Pi.

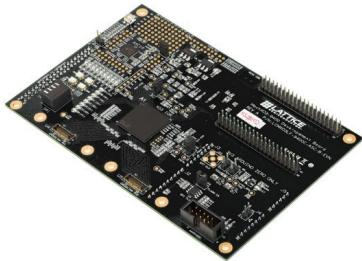

### Features

- MachXO3LF-9400C-484caBGA and L-ASC10 devices with multiple prototyping and breakout areas
- Arduino and Raspberry Pi development board connectors
- LEDs and switches for demos and evaluation
- On-board FTDI device supports JTAG programming and I<sup>2</sup>C Interfacing over USB cable
- Footprint support for CrossLink I/O link connectors and ASC expansion board connectors

### Ordering Part Number

LCMXO3LF-9400C-ASC-B-EVN

## MachXO2 Boards and Kits

### MachXO2 Breakout Board

#### Features

- MachXO2 LCMXO2-7000HE
- Access to all device I/O via four 2 x 20 expansion header landings for I/O, JTAG and external power
- 60-hole prototype area
- USB Type-B (mini) connector for power and programming (cable included)
- Eight general purpose LEDs
- 3.3 V and 1.2 V supply rails

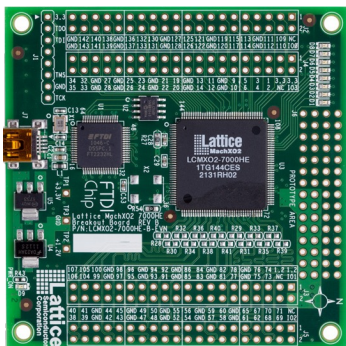

### MachXO2 Pico Development Kit

#### Features

- MachXO2 LCMXO2-1200ZE
- 4-character, 16-segment LCD display
- 4 capacitive touch sense buttons
- 1 Mbit SPI Flash
- I<sup>2</sup>C temperature sensor
- Current and voltage sensor circuits
- Expansion header for JTAG, I<sup>2</sup>C
- Standard USB cable for device programming and I<sup>2</sup>C communication
- RS-232/USB & JTAG/USB interface
- RoHS-compliant packaging and process
- Watch battery

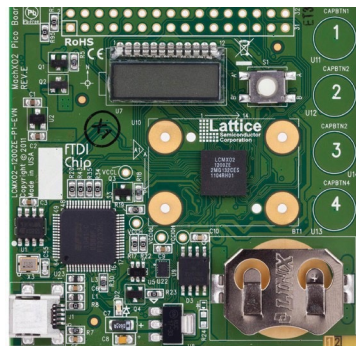

### MachXO2 Control Development Kit

#### Features

- MachXO2 LCMXO2-4000HC
- Power Manager II ispPAC-POWR1014A
- 128 Mbit LPDDR memory, 4Mbit SPI Flash
- Current and voltage sensor circuits
- SD memory card socket
- Microphone
- Audio amplifier and Delta-Sigma ADC
- Up to two DVI sources and one DVI output.
- Up to two Display inputs (7:1 LVDS) and one Display output (7:1 LVDS)
- Audio output channel
- Expansion header for JTAG, SPI, I<sup>2</sup>C and PLD I/O.
- LEDs & switches
- Standard USB cable for device programming
- RS-232/USB & JTAG/USB interface
- RoHS-compliant packaging and process
- AC adapter (international plugs)

### Ordering Part Number

|                         |                      |
|-------------------------|----------------------|
| Breakout Board          | LCMXO2-7000HE-B-EVN  |
| Pico Development Kit    | LCMXO2-1200ZE-P1-EVN |
| Control Development Kit | LCMXO2-4000HC-C-EVN  |

## MachXO5 Development Board

The MachXO5-NX Development Board is a full-featured board allowing the evaluation of MachXO5-NX in hardware management and I/O expansion.

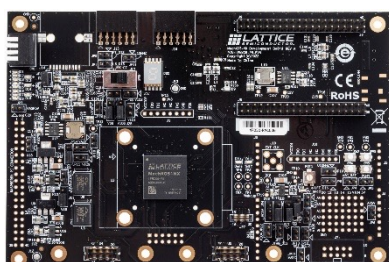

### Features

- On board MachXO5-25 caBGA Device
- Optional SGMII, Gbe PHY RJ45 connector and Aardvark header
- HyperRAM up to 166 MHz (333 Mbyte/s, x16 bits)
- ADC interface with 10K POT
- 7-Segment Blue LED, 4-position DIP Switches, 4 push buttons, and 8 red LEDs for demo
- Two Hirose FX12-40 headers and Multiple reference clock sources
- Versa Headers connection to Lattice L-ASC bridge board

### Ordering Part Number

LFMXO5-25-EVN

## MachXO5T-NX Development Board

The MachXO5T-NX Development Board is a full-featured board allowing the evaluation of LFMXO5-100 in hardware management and PCIe support.

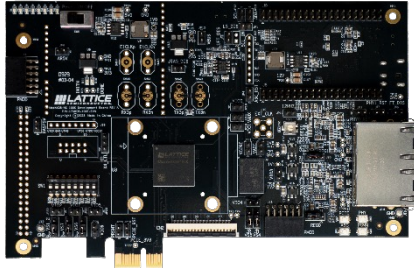

### Features

- Two Gbe PHY RJ45 connectors, with SGMII PHY support
- Supports LPDDR4 upto 1066Mbps, x16 bits
- Supports PCIe Gen2 x1 Edge Connector
- Versa Headers bridge with Lattice ASC Demo Board to support L-ASC10
- General Purpose Input/Output (GPIO) interface with PMOD, Arduino and Raspberry Pi boards

### Ordering Part Number

LFMXO5-100T-EVN

## Certus-NX Versa Evaluation Board

Connectivity Platform with 5G PCIe, SGMII, DDR3 Memory and 40k Logic Cells.

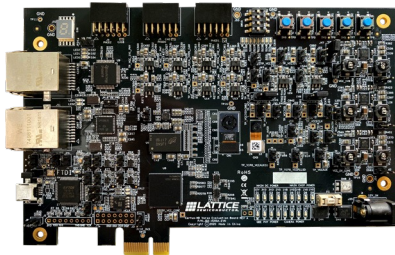

### Features

- Certus-NX FPGA (LFD2NX-40-8BG256C)
- Connectivity platform with 5G PCIe and SGMII: PCI Express 2.0 endpoint edge connector (x1 lane), two Gigabit Ethernet ports (one SGMII, one RGMII), DDR3 memory (with 1066 Mbps data rate x 16 data width) and two camera sensors (one using soft D-PHY interface, other using parallel interface)
- Efficient processing and expandable usability: Features Certus-NX low-power general purpose FPGA with 40k logic cells in a 256-BGA package. Board functions expandable via three Digilent

- Peripheral Module (Pmod™) headers available on the board
- USB-B connection for device programming and Inter-Integrated Circuit (I<sup>2</sup>C) utility
- On-board Boot Flash: 128 Mbit Serial Peripheral Interface (SPI) Flash, with Quad read feature
- Four input DIP switches, five push buttons, eight status LEDs and one 7-segment LED for customer purposes
- Multiple reference clock sources

### Ordering Part Number

LFD2NX-VERSA-EVN

## ECP5 Evaluation Board

Prototyping Board with Abundant Logic, I/O, 5G SERDES and Expansion Headers.

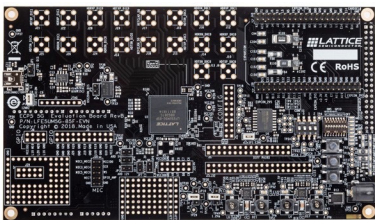

### Features

- ECP5-5G FPGA (LFE5UM5G-85F-8BG381)
- More I/O access: 178 I/O (including 20 differential pair I/O), four 5G SERDES, and most configuration pins accessible
- Expandable usability: Arduino, Raspberry Pi, Digilent Peripheral Module (Pmod™), Microphone Daughter Card (MDC) and general purpose I/O expansion headers
- USB-B connection for device programming and Inter-Integrated Circuit (I<sup>2</sup>C) utility and future capability to support Improved Inter-Integrated Circuit (I<sup>3</sup>C)

- On-board Boot Flash: 128 Mbit Serial Peripheral Interface (SPI) Flash, with Quad read feature
- 8 input DIP switches, 3 push buttons and 8 LEDs for demo purposes
- Multiple reference clock sources

### Ordering Part Number

LFE5UM5G-85F-EVN

## ECP5 and ECP5-5G Versa Development Kits

For evaluation and development with the ECP5 and ECP5-5G FPGAs, including PCI Express, Gigabit Ethernet, DDR3 and generic SERDES performance.

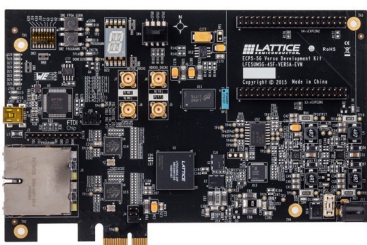

### Features

- Half-length PCI Express form factor: allows demonstration of PCI Express x1 interconnection
- Electrical testing of one full-duplex SERDES channel via SMA connections
- USB Type-B connection for UART and device programming
- Two RJ45 interfaces to 10/100/1000 Ethernet to RGMII
- On-board boot Flash: 128 Mbit Serial SPI Flash
- DDR3-1866 memory components (64 Mbit/x16)

- Expansion mezzanine interconnection for prototyping
- 14-segment alphanumeric display
- Switches, LEDs and displays for demo purposes
- Diamond® programming support
- On-board reference clock sources

### Ordering Part Number

LFE5UM-45F-VERSA-EVN

LFE5UM5G-45F-VERSA-EVN

# Development Kits

General Purpose FPGAs

## LatticeECP3 Versa Development Kit

Industry's lowest cost platform for designing PCI Express and Gigabit Ethernet based systems. The kit includes free demos and reference designs.

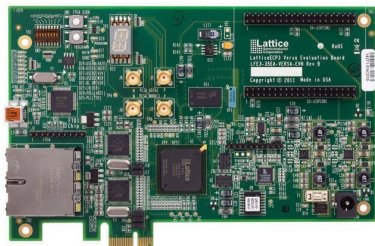

### Features

- The LatticeECP3 Versa Evaluation Board:
- PCI Express 1.1 x1 Edge connector interface
- Two Gigabit Ethernet ports (RJ45)
- 4 SMA connectors for SERDES access
- USB Type-B (mini) for FPGA programming
- LatticeECP3 FPGA: LFE3-35EA-FF484
- 64 Mbit Serial Flash memory
- 1GB DDR3 Memory
- 14 segment alphanumeric display
- Switches and LEDs for demos
- SERDES Eye Quality Demo
- 4 PCI Express Demos
- Gigabit Ethernet MAC Demo using Mico32
- DDR3 Memory Controller Demo
- Available on Windows and Linux platforms
- USB Type-A to Type-B (mini) cable for FPGA programming via PC
- 12 V AC power adapter and international plug adapters

### Ordering Part Number

LFE3-35EA-VERSA-EVN

LatticeXP2

## LatticeXP2 Brevia2 Development Kit

Easy-to-use, low-cost platform for evaluating and designing with Lattice XP2 FPGAs.

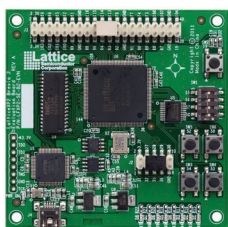

### Features

- LatticeXP2 FPGA: LFXP2-5E-6TN144C
- 2 Mbit SPI Flash memory
- 1 Mbit SRAM
- Programmed via included mini-USB Cable
- 2 x 20 and 2 x 5 expansion headers
- Push buttons for general purpose I/O and reset
- 4-bit DIP Switch for user-defined inputs
- 8 Status LEDs for user-defined outputs

### Ordering Part Number

LFXP2-5E-B2-EVN

LPTM21

## Platform Manager 2 Development Kit

The Platform Manager 2 Development Kit is a versatile, ready-to-use hardware platform for evaluating and designing with Platform Manager 2 and L-ASC10 devices. This kit includes a board, programming cable, and assorted example designs and documentation available for download. You can implement and debug your hardware management functions (power, thermal and control plane management) and test them out with this kit.

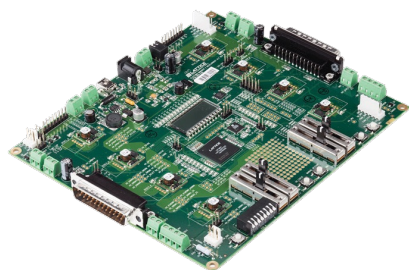

### Features

- LPTM21 (Platform Manager 2 device) & L-ASC10 (Hardware Management expander)
- Temperature monitoring/measurement, with temperature control using fan (included)
- Fault logging under various types of hardware management faults
  - 4 potentiometers & 2 POLs for sequencing, VID/Voltage scaling, margining, fault creation
- Background programming support with Dual boot from golden image stored on the SPI Flash
- Hardware management expansion through external L-ASC10 boards
- 3-digit LCD for additional code debug support

### L-ASC10 Breakout Board

The L-ASC10 (ASC) Breakout Board is a versatile hardware platform for evaluation and design with L-ASC10 devices. The board is designed to work alongside the Platform Manager 2 Development Kit.

### Features

- L-ASC10 (Hardware Management Expander)
- 2 potentiometers for sequencing & fault creation
- 9 LEDs for sequencing
- Temperature monitor & measurement with 2 on-board temperature sensors
- Connector for use with Platform Manager 2 Development Kit

### Ordering Part Number

|                                    |                |
|------------------------------------|----------------|
| Platform Manager 2 Development Kit | LPTM-BPM-EVN   |
| L-ASC10 Breakout Board             | LPTM-ASC-B-EVN |

## CertusPro-NX Evaluation Board

Prototyping Board with Abundant I/O, SERDES channels, Expansion Headers and 100k Logic Cells.

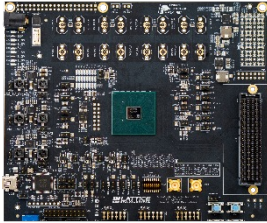

### Features

- CertusPro-NX FPGA (LFCPNX-100-9LFG672C)
- Expandable usability: General purpose Input/Output (GPIO) breakout with FMC connector, PMOD, and Raspberry PI
- Total of 167 wide-range I/O and 132 high-speed differential I/O pairs extended onboard
- Contains 4× SerDes channels with SMA and 4× SerDes channels with HPC connector
- USB-B connection for device programming and Inter-Integrated Circuit Bus (I2C) utility

- With 2.54-mm standard GPIO extended area
- On-board Boot Flash – 128 Mb Serial Peripheral Interface (SPI) Flash, with Quad read feature
- Multiple reference clock sources

### Ordering Part Number

LFCPNX-EVN

## CertusPro-NX Versa Board

Enables designers to design and develop solutions with wide range support in MIPI, SFP+, 10 GbE, LPDDR4 and PCIe (Gen3).



### Features

- CertusPro-NX FPGA (LFCPNX-100-9LFG672I)
- PCIe x4 Gen3 supports the Endpoint and Root port configuration
- Supports 2×SFP in 10G Ethernet and 1G SGMII
- With 2×SerDes channels with SMA and LPDDR4 DRAM Memory
- On-board Boot Flash – 128 Mb Serial Peripheral Interface (SPI) Flash, with Quad read feature

- USB-B connection for device programming and Inter-Integrated Circuit Bus (I2C) utility
- MIPI CSI-2 Camera connector
- Multiple reference clock sources

### Ordering Part Number

LFCPNX-VERSA-EVN

## CertusPro-NX Voice and Vision Machine Learning Board

CertusPro™-NX FPGA board is ideal for machine learning applications and features onboard HyperRAM as well as PMOD (Peripheral Module) connectors for off board support.

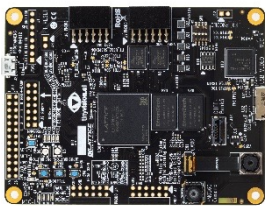

### Features

- CertusPro-NX FPGA (LFCPNX-100-BBG484)
- 4-lane MIPI CSI-2 receiver (Soft D-PHY) interface for high resolution camera data
- Support I2S interface for audio data from two microphones

- With 2\*64 Mb HyperRAM available for ML (Machine Learning) applications
- Cypress CYUSB3014 for Video Output to PC over USB3
- 4 PMOD connectors expansion headers available

### Ordering Part Number

LFCPNX-VVML-EVN

## CertusPro-NX PCIe Bridge Board

Enables video bridge capabilities to PCIe and embedded vision type applications and offering flexible FMC based Camera, Video or Networking I/O options.

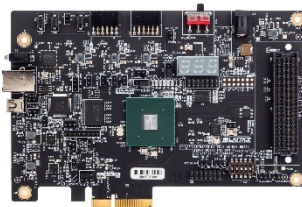

### Features

- CertusPro-NX FPGA (LFCPNX-100-9LFG672I)
- Supports PCIe x4 Gen3 and LPDDR4 DRAM Memory
- On-board Boot Flash – 128 Mb Serial Peripheral Interface (SPI) Flash, with Quad read feature
- USB 3.0 Controller
- FMC connector

- USB-B connection for device programming and Inter-Integrated Circuit Bus (I2C) utility
- Multiple reference clock sources

### Ordering Part Number

LFCPNX-PCIEB-EVN

## Avant-E Evaluation Board

Enables designers with rapid prototyping and testing their FPGA designs with FMC HPC, PMOD, and Raspberry PI connectors.

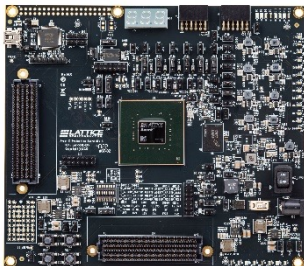

### Features

- Avant-E FPGA (LAV-AT-500E-3LFG1156C)
- Expandable usability: General purpose Input/Output (GPIO) breakout with 2 FMC, PMOD, and Raspberry PI connectors
- Total of 95 wide-range I/O and 468 high-speed differential I/O (234 pairs) extended onboard
- USB-B (Mini) connection for device programming
- On-board Boot Flash – 512 Mb Serial Peripheral Interface (SPI) Flash, with Single/Dual/Quad support
- 8 input DIP switches, 4 push buttons, 8 green LEDs, 8 red LEDs and 3 seven-segment LEDs for designer configuration
- Two reference clock sources

### Ordering Part Number

LAV-500E-EVN

# Programming Hardware

## Programming Cables

Lattice Programming Cables are used to communicate between a PC and a Lattice device on a target board or system. The most common application is to program a Lattice device. Programming Cables can also be used to help debug your hardware designs via Lattice software tools.

- **USB Programming Cable (HW-USBN-2B – pictured).** The latest-generation Programming Cable adds I<sup>2</sup>C programming and various other features.
- **Parallel Cable (HW-DLN-3C).** This connects to a PC parallel port and is best for basic JTAG programming.
- **First-generation USB Programming Cable (HW-USBN-2A)** – The simplest and fastest way to program all Lattice 1.2V, 1.8V, 2.5V, 3.3V, or 5V CPLD and FPGA devices.



| Ordering Part Number        |            |
|-----------------------------|------------|
| Isp DOWNLOAD Parallel Cable | HW-DLN-3C  |
| First Programming Cable     | HW-USBN-2A |
| USB Programming Cable       | HW-USBN-2B |

## Smart Sockets

Lattice Smart Sockets are an all-in-one solution for prototype programming of the latest Lattice products.

These complete solutions include all the functionality of a Desktop Programmer + Socket Adapter combination in a single board. All that's needed is a simple connection to your PC via USB (cable included).

More information about Lattice Smart Sockets is on the Lattice website at [www.latticesmi.com/sockets](http://www.latticesmi.com/sockets).

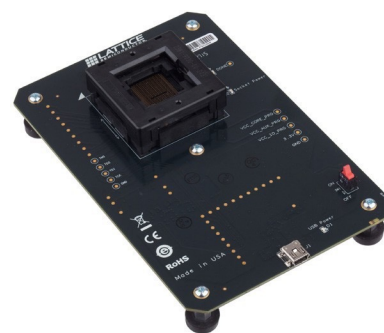

## Desktop Programmers

Lattice offers two desktop programmers for prototype programming of Lattice products.

A Socket Adapter is required for the specific device/package you wish to program. These are available separately, and are designed specifically for one Desktop Programmer or the other.

The Lattice Model 300 Desktop Programmer (pictured) supports most Lattice FPGA and CPLD products.

The iCEprog Desktop Programmer supports all Lattice iCE products.



| Ordering Part Number         |                 |
|------------------------------|-----------------|
| Model 300 Desktop Programmer | PDS4 102-PM300N |
| iCEprog Desktop Programmer   | ICEPROGM1050-01 |

## Socket Adapters

Lattice Socket Adapters are used in conjunction with a Lattice Desktop programmer to facilitate low-volume, manual programming of Lattice devices.

Socket adapters are generally designed to support a device family/package combination.

iCE Socket Adapters work only with the iCEprog Desktop Programmer. All other Lattice Socket Adapters work only with the Model300 Desktop Programmer.

More information and a complete list of Lattice Socket Adapter products is available at [www.latticesmi.com/sockets](http://www.latticesmi.com/sockets).

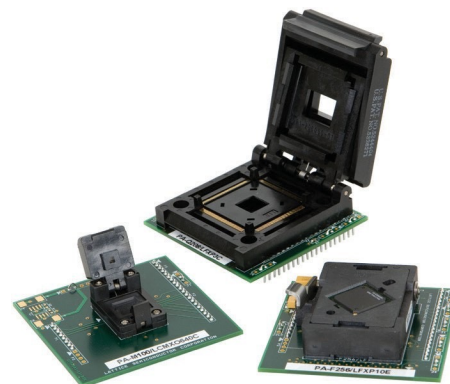

# FPGA and CPLD Design Software

| Best in Class Design Tools            |   | Lattice Radiant (Subscription) | Lattice Radiant (Free) | Lattice Diamond™ (Subscription)                                 | Lattice Diamond™ (Free)                          | ispLEVER™ Classic (Subscription) | iCEcube2™ (Free)    | PAC-Designer (Free) | Lattice Propel (Free) |
|---------------------------------------|---|--------------------------------|------------------------|---|--|----------------------------------|---------------------|---------------------|-----------------------|
| Device Families                       | Avant-E                                       | ✓                              |                        |   |  |                                  |                     |                     | ✓                     |
|                                       | MachXO5-NX                                    | ✓                              |                        |   |  |                                  |                     |                     | ✓                     |
|                                       | CertusPro-NX                                  | ✓                              |                        |   |  |                                  |                     |                     | ✓                     |
|                                       | Certus-NX                                     | ✓                              | ✓                      |   |  |                                  |                     |                     | ✓                     |
|                                       | CrossLink                                     |                                |                        | ✓   | ✓  |                                  |                     |                     |                       |
|                                       | CrossLinkPlus                                 |                                |                        | ✓   | ✓  |                                  |                     |                     |                       |
|                                       | CrossLink-NX                                  | ✓                              | ✓                      |   |  |                                  |                     |                     |                       |
|                                       | ECP5UM5G                                      |                                |                        | ✓   |  |                                  |                     |                     |                       |
|                                       | ECP5U   |                                |                        | ✓   | ✓  |                                  |                     |                     |                       |
|                                       | ECP5UM  |                                |                        | ✓   |  |                                  |                     |                     |                       |
|                                       | LatticeECP3                                   |                                |                        | ✓   |  |                                  |                     |                     |                       |
|                                       | LatticeECP2M/S                                |                                |                        | ✓   |  |                                  |                     |                     |                       |
|                                       | LatticeECP2S                                  |                                |                        | ✓   |  |                                  |                     |                     |                       |
|                                       | MachXO/XO2/XO3                                |                                |                        | ✓   | ✓  |                                  |                     |                     |                       |
|                                       | MachXO3D                                      |                                |                        | ✓   | ✓  |                                  |                     |                     | ✓                     |
|                                       | Mach-NX                                       |                                |                        | ✓   | ✓  |                                  |                     |                     | ✓                     |
|                                       | LatticeXP2                                    |                                |                        | ✓   | ✓  |                                  |                     |                     |                       |
|                                       | LatticeECP2                                   |                                |                        | ✓   | ✓  |                                  |                     |                     |                       |
|                                       | iCE40   |                                |                        |   |  |                                  | ✓                   |                     |                       |
|                                       | iCE40 UltraPlus                               | ✓                              | ✓                      |   |  | ✓                                |                     |                     |                       |
|                                       | ispMACH 4000B/C/V/ZE                          |                                |                        |   |  |                                  |                     |                     |                       |
|                                       | Platform Manager 2                            |                                |                        | ✓   | ✓  |                                  |                     |                     |                       |
| L-ASC10                               |   |                                | ✓                      | ✓   |  |                                  |                     |                     |                       |
| Power Manager II                      |   |                                |                        |   |  |                                  | ✓                   |                     |                       |
| Software Features                     | Design Exploration                            | ✓                              | ✓                      | ✓   | ✓  |                                  | ✓                   |                     |                       |
|                                       | VHDL & Verilog Support                        | ✓                              | ✓                      | ✓   | ✓  | ✓                                | ✓                   |                     |                       |
|                                       | Schematic Support                             | ✓                              | ✓                      | ✓   | ✓  | ✓                                |                     |                     |                       |
|                                       | ABEL  |                                |                        |   |  | ✓                                |                     | ✓                   |                       |
|                                       | Synopsys® Synplify Pro™ for Lattice-Synthesis | ✓                              | ✓                      | ✓   | ✓  | ✓                                |                     |                     |                       |
|                                       | Lattice Synthesis Engine (LSE)                | FPGA only                      | FPGA only              | MachXO/XO2/XO3/XO3D<br>Lattice ECP2/ECP3/ECP5/ECP5-5G/ECP2M/XP2 | MachXO/XO2/MachXO3/XO3D<br>LatticeECP2/ECP5U/XP2 | ispMACH 4000 only                | ✓                   |                     |                       |
|                                       | Embedded Security Block                       |                                |                        | FPGA only   |  |                                  |                     |                     |                       |
|                                       | Security / Encrypted Bit-Stream               |                                | CrossLink-NX           | ✓   |  |                                  |                     |                     |                       |
|                                       | IP and Module Configuration                   | ✓                              | ✓                      | ✓   | ✓  | Module Only                      | Module Only         |                     |                       |
|                                       | Power Estimation & Calculation                | ✓                              | ✓                      | ✓   | ✓  |                                  | ✓                   |                     |                       |
|                                       | Propel Builder                                |                                |                        |   |  |                                  |                     |                     | ✓                     |
|                                       | Propel SDK                                    |                                |                        |   |  |                                  |                     |                     | ✓                     |
|                                       | Timing Analysis                               | ✓                              | ✓                      | ✓   | ✓  | ✓                                | ✓                   |                     |                       |
|                                       | Floorplanning                                 | ✓                              | ✓                      | ✓   | ✓  | ✓                                | ✓                   |                     |                       |
|                                       | On-Chip Debug                                 | ✓                              | ✓                      | ✓   | ✓  | ispXPGA Only                     |                     |                     |                       |
|                                       | TCL Scripting Dictionaries                    | ✓                              | ✓                      | ✓   | ✓  |                                  |                     |                     |                       |
| Mentor ModelSim® Lattice FPGA Edition | ✓   | ✓                              | ✓                      | ✓   | ✓  | ✓                                |                     |                     |                       |
| Operating Systems                     | Windows (64 bit)                              | Windows 10/11                  |                        | Windows 10  |  | Windows 7/10                     |                     |                     | Windows 10            |
|                                       | Linux   | RHEL v7.7 and v8.4             |                        | RHEL v6 and v7  |  |                                  | RHEL v6             |                     | RHEL v7.7 and v8.4    |
|                                       | Ubuntu  | v10.08 and v20.04 LTS          |                        |   |  |                                  |                     |                     | v20.04 LTS            |
| Licensing & Updates                   | License Terms                                 | One Year, Renewable            | One Year, Renewable    | One Year, Renewable   | One Year, Renewable                              | One Year, Renewable              | One Year, Renewable |                     | One Year, Renewable   |
|                                       | Node-Locked License                           | ✓                              | ✓                      | ✓   | ✓  | ✓                                | ✓                   |                     | ✓                     |
|                                       | Floating License                              | ✓                              | ✓                      | ✓   | ✓  | ✓                                |                     |                     |                       |





**Software Licensing**  
[latticesemi.com/licensing](https://latticesemi.com/licensing)

**Technical Support**  
[latticesemi.com/support](https://latticesemi.com/support)

Copyright © 2023 Lattice Semiconductor Corporation, Lattice Semiconductor (& design), Certus-NX, CertusPro-NX, CrossLink, CrossLinkPlus, CrossLink-NX, iCE40, iCE40 Ultra, iCE40 UltraLite, iCE 40 UltraPlus, Mach-NX, MachXO, MachXO2, MachXO3, MachXO3D, MachXO3L, MachXO3H, ispMACH, LatticeXP2, ECP5, ECP5-G, LatticeECP3, LatticeECP2/M, Lattice Diamond, Lattice mVision, Lattice Nexus, Lattice Radiant, Lattice sensAI, Lattice Sentry, Lattice SupplyGuard, Lattice Automate, ispLever, iCEcube, iCEcube2, and specific product designations are either registered trademarks or trademarks of Lattice Semiconductor Corporation or its subsidiaries in the United States and/or other countries. MIPI is a licensed trademark of MIPI, Inc. in the U.S. and other jurisdictions.



December 2023 • Order #: I0211 Rev. 41