

## High Speed Infrared Emitting Diodes, 940 nm, Surface Emitter Technology

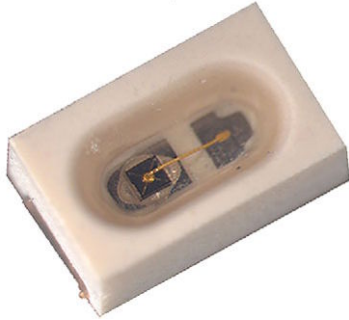

### FEATURES

- Package type: surface-mount
- Package form: 0805
- Dimensions (L x W x H in mm): 2 x 1.25 x 0.8
- Peak wavelength:  $\lambda_p = 940$  nm
- AEC-Q101 qualified
- High speed
- Angle of half intensity:  $\phi = \pm 60^\circ$
- 0805 standard surface-mountable package
- Floor life: 168 h, MSL 3, according to J-STD-020
- Lead (Pb)-free reflow soldering
- Material categorization: for definitions of compliance please see [www.vishay.com/doc?99912](http://www.vishay.com/doc?99912)

 AUTOMOTIVE  
GRADE

**RoHS**  
COMPLIANT  
HALOGEN  
**FREE**  
**GREEN**  
(5-2008)

### DESCRIPTION

As part of the [SurfLight™](#) portfolio, the VSMY5940X01 is an infrared, 940 nm emitting diode based on GaAlAs surface emitter chip technology with high radiant intensity, high optical power and high speed, in a low profile 0805 surface mount (SMD) package.

### APPLICATIONS

- Miniature light barrier
- Automotive sensors
- Optical switch
- IR point source

### PRODUCT SUMMARY

COMPONENT	$I_e$ (mW/sr) at $I_F = 100$ mA	$\phi$ (°)	$\lambda_p$ (nm)	$t_r$ (ns)
VSMY5940X01	13	$\pm 60$	940	7

#### Note

- Test conditions see table “Basic Characteristics“

### ORDERING INFORMATION

ORDERING CODE	PACKAGING	REMARKS	PACKAGE FORM
VSMY5940X01	Tape and reel	MOQ: 3000 pcs, 3000 pcs/reel	0805

#### Note

- MOQ: minimum order quantity



ABSOLUTE MAXIMUM RATINGS (T <sub>amb</sub> = 25 °C, unless otherwise specified)				
PARAMETER	TEST CONDITION	SYMBOL	VALUE	UNIT
Reverse voltage		V <sub>R</sub>	5	V
Forward current		I <sub>F</sub>	100	mA
Peak forward current	t <sub>p</sub> /T = 0.1, t <sub>p</sub> = 100 μs	I <sub>FM</sub>	200	mA
Surge forward current	t <sub>p</sub> = 100 μs	I <sub>FSM</sub>	500	mA
Power dissipation		P <sub>V</sub>	190	mW
Junction temperature		T <sub>j</sub>	125	°C
Operating temperature range		T <sub>amb</sub>	-40 to +110	°C
Storage temperature range		T <sub>stg</sub>	-40 to +110	°C
Soldering temperature	According to Fig. 7, J-STD-020	T <sub>sd</sub>	260	°C
Thermal resistance junction-to-ambient	EIA / JESD51	R <sub>thJA</sub>	280	K/W

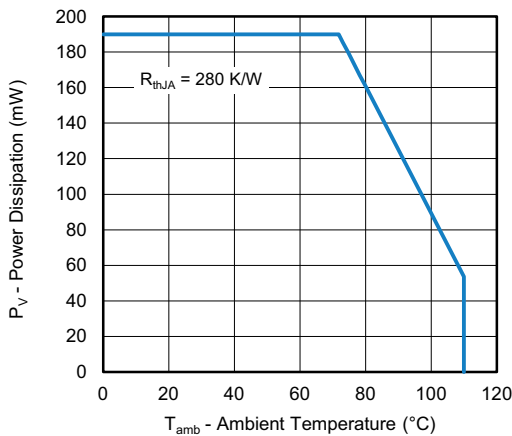

Fig. 1 - Power Dissipation Limit vs. Ambient Temperature

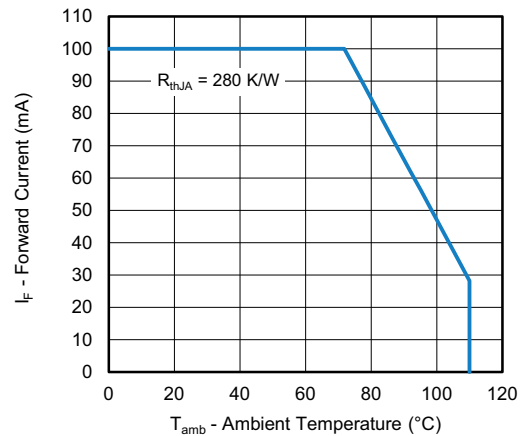

Fig. 2 - Forward Current Limit vs. Ambient Temperature

BASIC CHARACTERISTICS (T <sub>amb</sub> = 25 °C, unless otherwise specified)						
PARAMETER	TEST CONDITION	SYMBOL	MIN.	TYP.	MAX.	UNIT
Forward voltage	I <sub>F</sub> = 100 mA, t <sub>p</sub> = 20 ms	V <sub>F</sub>	-	1.6	1.9	V
Temperature coefficient of V <sub>F</sub>	I <sub>F</sub> = 100 mA, t <sub>p</sub> = 20 ms	TK <sub>V<sub>F</sub></sub>	-	-0.7	-	mV/K
Reverse current		I <sub>R</sub>	Not designed for reverse operation			μA
Junction capacitance	V <sub>R</sub> = 0 V, f = 1 MHz, E = 0 mW/cm <sup>2</sup>	C <sub>J</sub>	-	30	-	pF
Radiant intensity	I <sub>F</sub> = 100 mA, t <sub>p</sub> = 20 ms	I <sub>e</sub>	9	13	18	mW/sr
Temperature coefficient of radiant power	I <sub>F</sub> = 100 mA, t <sub>p</sub> = 20 ms	TK <sub>φ<sub>e</sub></sub>	-	-0.2	-	%/K
Angle of half intensity		φ	-	± 60	-	°
Peak wavelength	I <sub>F</sub> = 100 mA, t <sub>p</sub> = 20 ms	λ <sub>p</sub>	-	940	-	nm
Spectral bandwidth	I <sub>F</sub> = 100 mA, t <sub>p</sub> = 20 ms	Δλ	-	55	-	nm
Temperature coefficient of λ <sub>p</sub>	I <sub>F</sub> = 100 mA, t <sub>p</sub> = 20 ms	TK <sub>λ<sub>p</sub></sub>	-	0.28	-	nm/K
Rise time	I <sub>F</sub> = 100 mA, 10 % to 90 %	t <sub>r</sub>	-	5	-	ns
Fall time	I <sub>F</sub> = 100 mA, 10 % to 90 %	t <sub>f</sub>	-	5	-	ns

**BASIC CHARACTERISTICS** ( $T_{amb} = 25\text{ }^{\circ}\text{C}$ , unless otherwise specified)

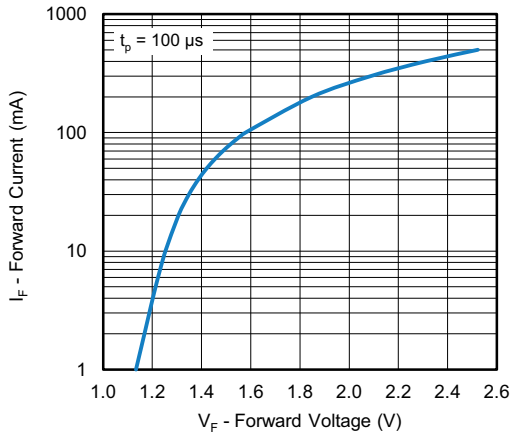

Fig. 3 - Forward Current vs. Forward Voltage

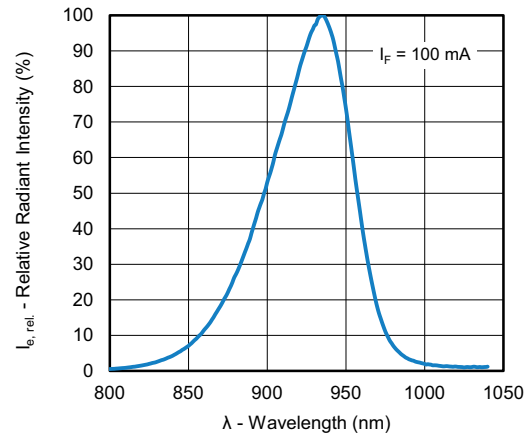

Fig. 5 - Relative Radiant Power vs. Wavelength

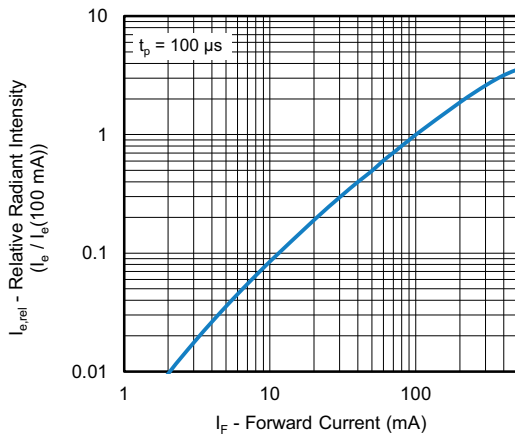

Fig. 4 - Relative Radiant Intensity vs. Forward Current



Fig. 6 - Relative Radiant Intensity vs. Angular Displacement

**REFLOW SOLDER PROFILE**



19841

Fig. 7 - Lead (Pb)-free Reflow Solder Profile According to J-STD-020

**DRYPACK**

Devices are packed in moisture barrier bags (MBB) to prevent the products from moisture absorption during transportation and storage. Each bag contains a desiccant.

**FLOOR LIFE**

Time between soldering and removing from MBB must not exceed the time indicated in J-STD-020:

Moisture sensitivity: level 3

Floor life: 168 h

Conditions:  $T_{amb} < 30\text{ }^{\circ}\text{C}$ ,  $\text{RH} < 60\%$

**DRYING**

In case of moisture absorption devices should be baked before soldering. Conditions see J-STD-033D or label. Devices taped on reel dry using recommended conditions 192 h at  $40\text{ }^{\circ}\text{C}$  (+ 5 °C),  $\text{RH} < 5\%$ .

**PACKAGE DIMENSIONS** in millimeters



Drawing- No.: 6.550-5352.01-4  
Issue: 1; 20.12.2016

**BLISTER TAPE DIMENSIONS** in millimeters

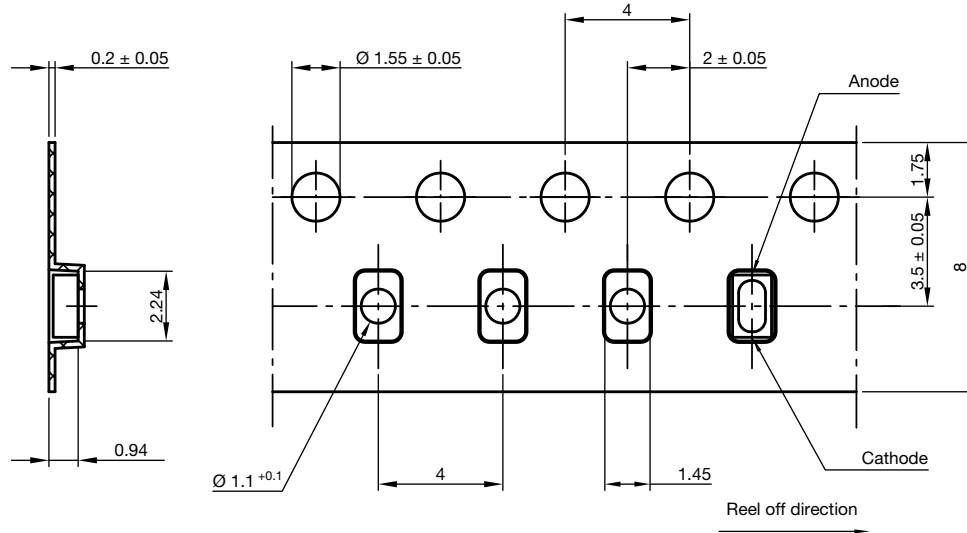

Not indicated tolerances ± 0.1



Technical drawings according to DIN specification.

Drawing-No.: 9.700-5352.02-4  
Issue: 1; 20.12.2016

**REEL DIMENSIONS** in millimeters

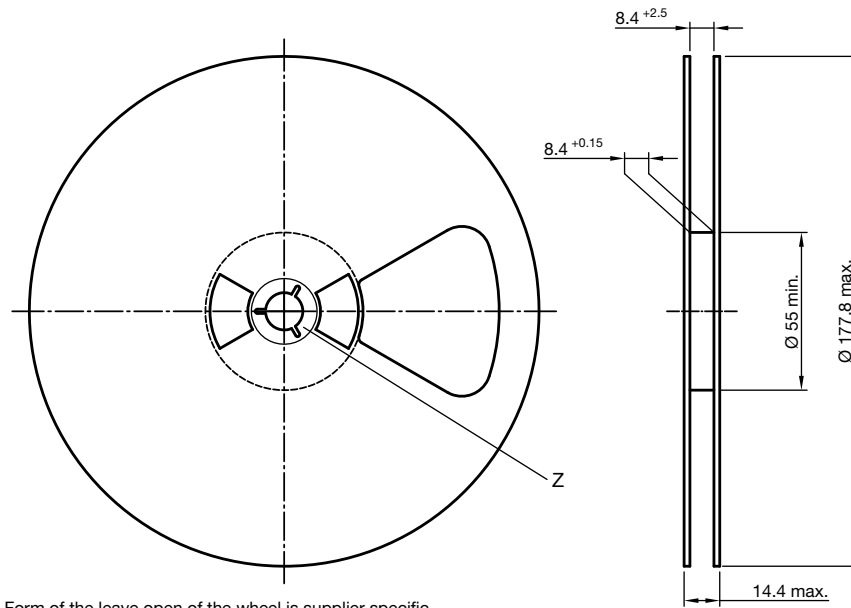

Form of the leave open of the wheel is supplier specific.

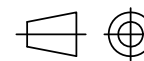
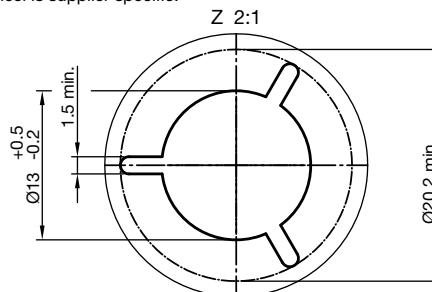

Technical drawings according to DIN specification.

Drawing-No.: 9.800-5096.01-4  
Issue: 5; 20.12.2016



## Disclaimer

ALL PRODUCT, PRODUCT SPECIFICATIONS AND DATA ARE SUBJECT TO CHANGE WITHOUT NOTICE TO IMPROVE RELIABILITY, FUNCTION OR DESIGN OR OTHERWISE.

Vishay Intertechnology, Inc., its affiliates, agents, and employees, and all persons acting on its or their behalf (collectively, "Vishay"), disclaim any and all liability for any errors, inaccuracies or incompleteness contained in any datasheet or in any other disclosure relating to any product.

Vishay makes no warranty, representation or guarantee regarding the suitability of the products for any particular purpose or the continuing production of any product. To the maximum extent permitted by applicable law, Vishay disclaims (i) any and all liability arising out of the application or use of any product, (ii) any and all liability, including without limitation special, consequential or incidental damages, and (iii) any and all implied warranties, including warranties of fitness for particular purpose, non-infringement and merchantability.

Statements regarding the suitability of products for certain types of applications are based on Vishay's knowledge of typical requirements that are often placed on Vishay products in generic applications. Such statements are not binding statements about the suitability of products for a particular application. It is the customer's responsibility to validate that a particular product with the properties described in the product specification is suitable for use in a particular application. Parameters provided in datasheets and / or specifications may vary in different applications and performance may vary over time. All operating parameters, including typical parameters, must be validated for each customer application by the customer's technical experts. Product specifications do not expand or otherwise modify Vishay's terms and conditions of purchase, including but not limited to the warranty expressed therein.

Hyperlinks included in this datasheet may direct users to third-party websites. These links are provided as a convenience and for informational purposes only. Inclusion of these hyperlinks does not constitute an endorsement or an approval by Vishay of any of the products, services or opinions of the corporation, organization or individual associated with the third-party website. Vishay disclaims any and all liability and bears no responsibility for the accuracy, legality or content of the third-party website or for that of subsequent links.

Vishay products are not designed for use in life-saving or life-sustaining applications or any application in which the failure of the Vishay product could result in personal injury or death unless specifically qualified in writing by Vishay. Customers using or selling Vishay products not expressly indicated for use in such applications do so at their own risk. Please contact authorized Vishay personnel to obtain written terms and conditions regarding products designed for such applications.

No license, express or implied, by estoppel or otherwise, to any intellectual property rights is granted by this document or by any conduct of Vishay. Product names and markings noted herein may be trademarks of their respective owners.