

SCHOTTKY BARRIER DIODE

**FEATURE**

- Small surface mounting type
- Low reverse current and low forward voltage
- High reliability

**APPLICATION**

- High speed switching for detection
- For portable equipment:(i.e. Mobile phone,MP3, MD,CD-ROM, DVD-ROM, Note book PC, etc.)

**MARKING**

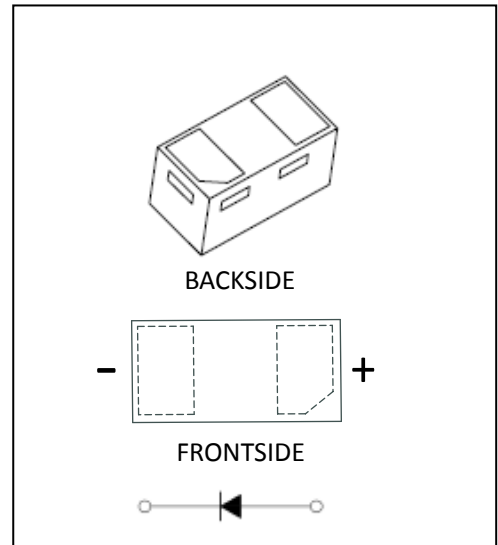

**MAXIMUM RATINGS** ( $T_a=25^{\circ}\text{C}$  unless otherwise noted)

Symbol	Parameter	Limit	Unit
$V_{RRM}$	Repetitive Peak Reverse Voltage	30	V
$V_{RWM}$	Working Peak Reverse Voltage		
$V_{R(RMS)}$	RMS Reverse Voltage	21	V
$I_o$	Average Rectified Output Current	100	mA
$I_{FSM}$	Non-Repetitive Peak Forward Surge Current@ t=8.3ms	0.5	A
$P_d$	Power Dissipation	100	mW
$R_{\theta JA}$	Thermal Resistance from Junction to Ambient	1000	$^{\circ}\text{C}/\text{W}$
$T_J$	Operating Junction Temperature Range	-40 ~ +125	$^{\circ}\text{C}$
$T_{stg}$	Storage Temperature Range	-55 ~ +150	$^{\circ}\text{C}$

**ELECTRICAL CHARACTERISTICS** ( $T_a = 25^{\circ}\text{C}$  unless otherwise specified)

Parameter	Symbol	Test Condition	Min	Typ	Max	Unit
Reverse breakdown voltage	$V_{(BR)}$	$I_R=50\mu\text{A}$	30			V
Reverse current	$I_R$	$V_R=10\text{V}$			10	$\mu\text{A}$
		$V_R=30\text{V}$			50	$\mu\text{A}$
Forward voltage	$V_F$	$I_F=10\text{mA}$			0.38	V
		$I_F=100\text{mA}$			0.60	V

Typical Characteristics

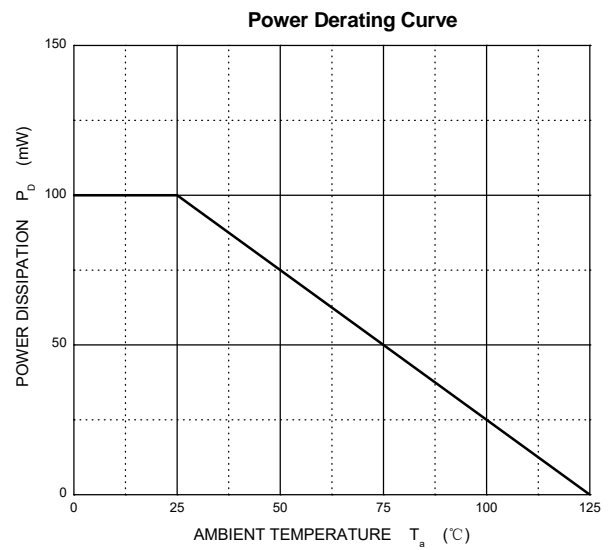
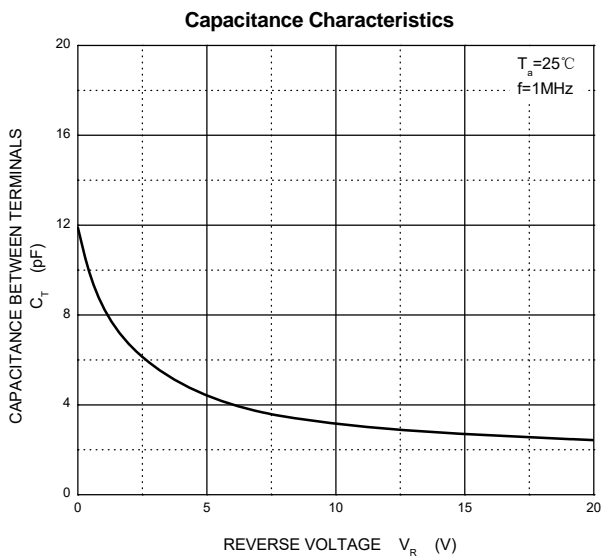
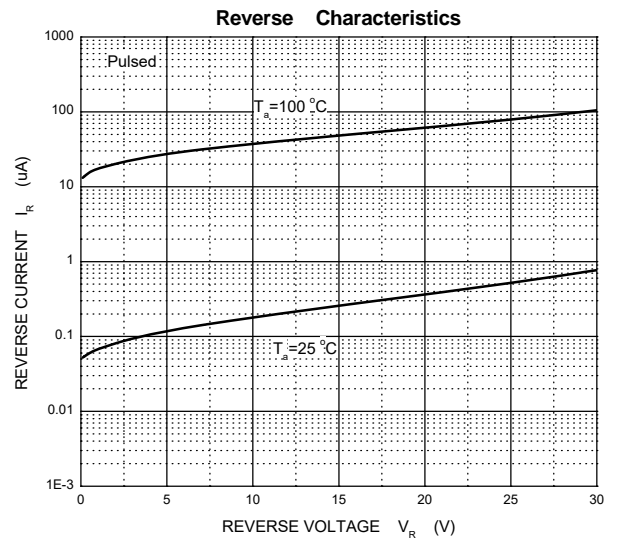
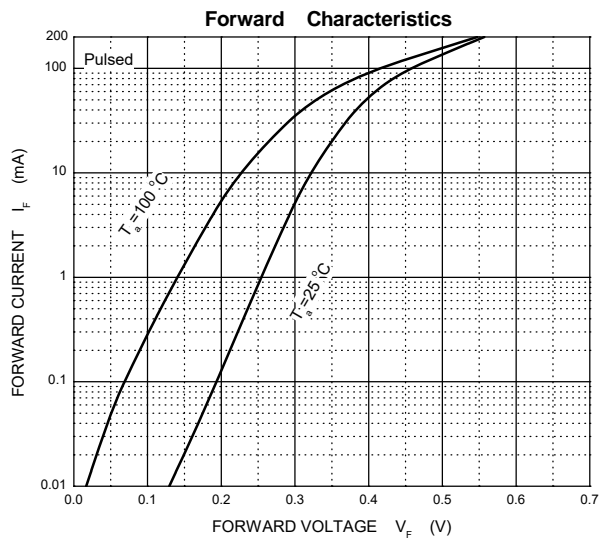

**DFN0603 Package Outline Dimensions**

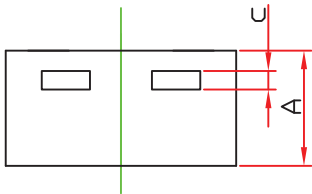
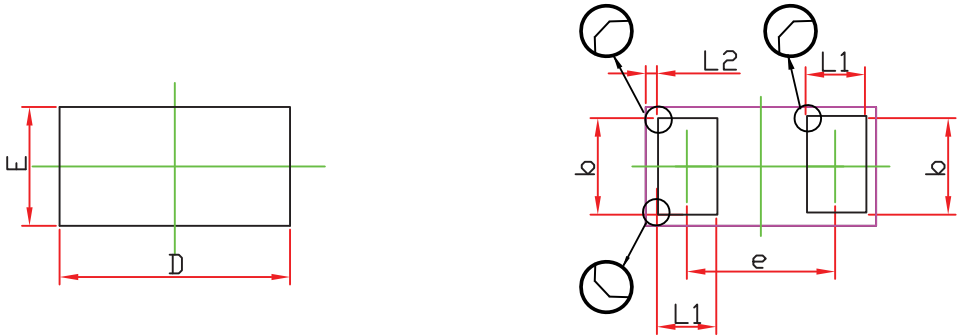

Symbol	Dimensions In Millimeters		Dimensions In Inches	
	Min.	Max.	Min.	Max.
A	0.270	0.340	0.010	0.013
D	0.550	0.670	0.021	0.026
E	0.250	0.370	0.009	0.015
b	0.200	0.350	0.008	0.014
c	0.050 REF.		0.002 REF.	
e	0.350	0.435	0.014	0.017
L1	0.125	0.230	0.005	0.009
L2	0.030 REF.		0.001 REF.	

**Suggested Pad Layout**

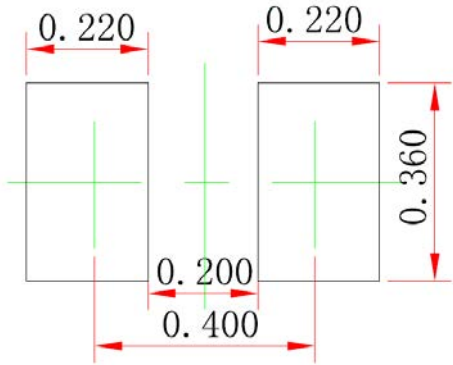

**Note:**  
 1. Controlling dimension: in millimeters.  
 2. General tolerance:  $\pm 0.050$  mm.  
 3. The pad layout is for reference purposes only.