



Features

- High Blocking Voltage with Low On-Resistance
- High Speed Switching with Low Capacitances
- Easy to Parallel and Simple to Drive
- Resistant to Latch-Up
- Halogen Free, RoHS Compliant

Benefits

- Higher System Efficiency
- Reduced Cooling Requirements
- Increased Power Density
- Increased System Switching Frequency

Applications

- Solar Inverters
- Switch Mode Power Supplies
- High Voltage DC/DC converters
- Battery Chargers
- Motor Drives
- Pulsed Power Applications

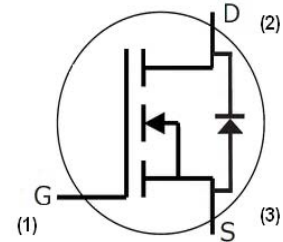
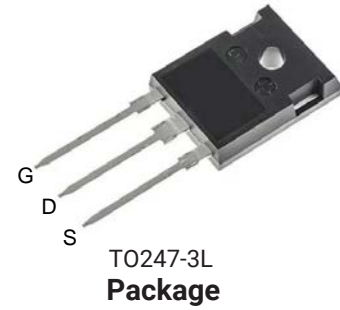

| Part Number | Package | Marking |
|--------------|----------|--------------|
| HC2M0040120D | TO247-3L | HC2M0040120D |

Maximum Ratings ($T_c = 25^\circ\text{C}$ unless otherwise specified)

| Symbol | Parameter | Value | Unit | Test Conditions | Note |
|----------------|--|-------------|------------------|---|---------|
| V_{DSmax} | Drain - Source Voltage | 1200 | V | $V_{GS} = 0\text{ V}, I_D = 100\ \mu\text{A}$ | |
| V_{GSmax} | Gate - Source Voltage | -10/+25 | V | Absolute maximum values | |
| V_{GSop} | Gate - Source Voltage | -5/+20 | V | Recommended operational values | |
| I_D | Continuous Drain Current | 55 | A | $V_{GS} = 20\text{ V}, T_C = 25^\circ\text{C}$ | Fig. 19 |
| | | 36 | | $V_{GS} = 20\text{ V}, T_C = 100^\circ\text{C}$ | |
| $I_{D(pulse)}$ | Pulsed Drain Current | 160 | A | Pulse width t_p limited by T_{jmax} | Fig. 22 |
| P_D | Power Dissipation | 278 | W | $T_c = 25^\circ\text{C}, T_J = 150^\circ\text{C}$ | Fig. 20 |
| T_J, T_{stg} | Operating Junction and Storage Temperature | -55 to +150 | $^\circ\text{C}$ | | |
| T_L | Solder Temperature | 260 | $^\circ\text{C}$ | 1.6mm (0.063") from case for 10s | |
| M_d | Mounting Torque | 1 | Nm lbf-in | M3 or 6-32 screw | |
| | | 8.8 | | | |



Electrical Characteristics ($T_c = 25^\circ\text{C}$ unless otherwise specified)

| Symbol | Parameter | Min. | Typ. | Max. | Unit | Test Conditions | Note |
|---------------|--|------|------|------|---------------|--|------------|
| $V_{(BR)DSS}$ | Drain-Source Breakdown Voltage | 1200 | | | V | $V_{GS} = 0\text{ V}, I_D = 100\ \mu\text{A}$ | |
| $V_{GS(th)}$ | Gate Threshold Voltage | 2.0 | 3.2 | 4 | V | $V_{DS} = V_{GS}, I_D = 10\text{mA}$ | Fig. 11 |
| | | | 2.4 | | V | $V_{DS} = V_{GS}, I_D = 10\text{mA}, T_J = 150^\circ\text{C}$ | |
| I_{DSS} | Zero Gate Voltage Drain Current | | 1 | 100 | μA | $V_{DS} = 1200\text{ V}, V_{GS} = 0\text{ V}$ | |
| I_{GSS} | Gate-Source Leakage Current | | | 250 | nA | $V_{GS} = 20\text{ V}, V_{DS} = 0\text{ V}$ | |
| $R_{DS(on)}$ | Drain-Source On-State Resistance | | 44 | 52 | m Ω | $V_{GS} = 20\text{ V}, I_D = 40\text{ A}$ | Fig. 4,5,6 |
| | | | 82 | | | $V_{GS} = 20\text{ V}, I_D = 40\text{ A}, T_J = 150^\circ\text{C}$ | |
| g_{fs} | Transconductance | | 18.2 | | S | $V_{DS} = 20\text{ V}, I_{DS} = 40\text{ A}$ | Fig. 7 |
| | | | 17.2 | | | $V_{DS} = 20\text{ V}, I_{DS} = 40\text{ A}, T_J = 150^\circ\text{C}$ | |
| C_{iss} | Input Capacitance | | 2440 | | pF | $V_{GS} = 0\text{ V}$ $V_{DS} = 1000\text{ V}$ $f = 1\text{ MHz}$ | Fig. 17,18 |
| C_{oss} | Output Capacitance | | 171 | | | | |
| C_{rss} | Reverse Transfer Capacitance | | 11 | | | | |
| E_{oss} | C_{oss} Stored Energy | | 89 | | μJ | $V_{AC} = 25\text{ mV}$ | Fig 16 |
| E_{ON} | Turn-On Switching Energy (Body Diode) | | 1.7 | | mJ | $V_{DS} = 800\text{ V}, V_{GS} = -5/20\text{ V}$ $I_D = 40\text{A}, R_{G(ext)} = 2.5\Omega, L = 99\ \mu\text{H}$ | Fig. 25 |
| E_{OFF} | Turn Off Switching Energy (Body Diode) | | 0.4 | | | | |
| E_{ON} | Turn-On Switching Energy (External SiC Diode) | | 1.3 | | | $V_{DS} = 800\text{ V}, V_{GS} = -5/20\text{ V}$ $I_D = 40\text{A}, R_{G(ext)} = 2.5\Omega, L = 99\ \mu\text{H}$ | |
| E_{OFF} | Turn Off Switching Energy (External SiC Diode) | | 0.4 | | | | |
| $t_{d(on)}$ | Turn-On Delay Time | | 13 | | ns | $V_{DD} = 800\text{ V}, V_{GS} = -5/20\text{ V}$ $I_D = 40\text{ A}$ $R_{G(ext)} = 2.5\ \Omega, R_L = 20\ \Omega$ Timing relative to V_{DS} Per IEC60747-8-4 pg 83 | Fig. 27 |
| t_r | Rise Time | | 61 | | | | |
| $t_{d(off)}$ | Turn-Off Delay Time | | 25 | | | | |
| t_f | Fall Time | | 13 | | | | |
| $R_{G(int)}$ | Internal Gate Resistance | | 1.8 | | Ω | $f = 1\text{ MHz}, V_{AC} = 25\text{ mV}$ | |
| Q_{gs} | Gate to Source Charge | | 34 | | nC | $V_{DS} = 800\text{ V}, V_{GS} = -5/20\text{ V}$ $I_D = 40\text{ A}$ Per IEC60747-8-4 pg 21 | Fig. 12 |
| Q_{gd} | Gate to Drain Charge | | 42 | | | | |
| Q_g | Total Gate Charge | | 120 | | | | |



Reverse Diode Characteristics

| Symbol | Parameter | Typ. | Max. | Unit | Test Conditions | Note |
|-----------------------|----------------------------------|------|------|------|--|---------------|
| V _{SD} | Diode Forward Voltage | 4.0 | | V | V _{GS} = - 5 V, I _{SD} = 20 A, T _J = 25 °C | Fig. 8, 9, 10 |
| | | 3.6 | | V | V _{GS} = - 5 V, I _{SD} = 20 A, T _J = 150 °C | |
| I _S | Continuous Diode Forward Current | | 60 | A | T _C = 25 °C | Note 1 |
| I _{S, pulse} | Diode Pulse Current | | 160 | A | V _{GS} = - 5 V, Pulse width t _p limited by T _{jmax} | |
| t _{rr} | Reverse Recovery Time | 54 | | ns | V _{GS} = - 5 V, I _{SD} = 40 A T _J = 25 °C VR = 800 V dif/dt = 1000 A/μs | Note 1 |
| Q _{rr} | Reverse Recovery Charge | 283 | | nC | | |
| I _{rrm} | Peak Reverse Recovery Current | 15 | | A | | |

Note (1): When using SiC Body Diode the maximum recommended V_{GS} = -5V

Thermal Characteristics

| Symbol | Parameter | Typ. | Max. | Unit | Test Conditions | Note |
|------------------|---|------|------|------|-----------------|---------|
| R _{θJC} | Thermal Resistance from Junction to Case | 0.33 | 0.45 | °C/W | | Fig. 21 |
| R _{θJC} | Thermal Resistance from Junction to Ambient | | 40 | | | |



Typical Performance

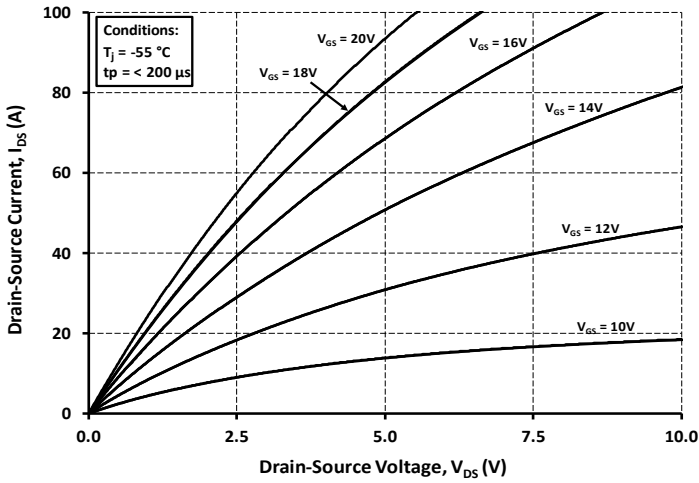

Figure 1. Output Characteristics $T_j = -55^\circ\text{C}$

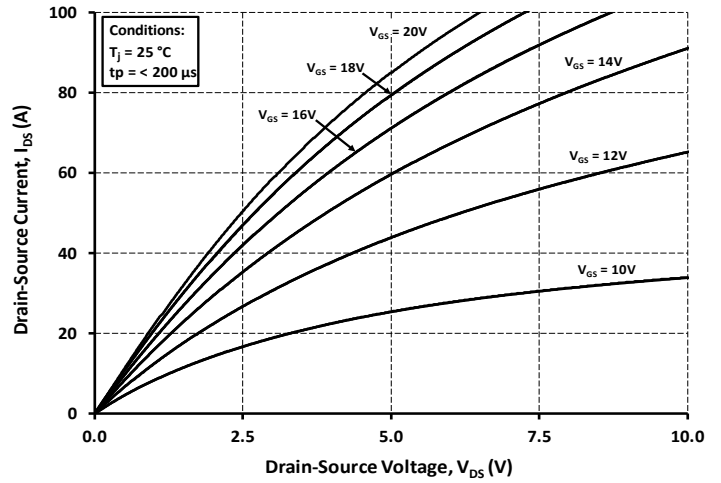

Figure 2. Output Characteristics $T_j = 25^\circ\text{C}$

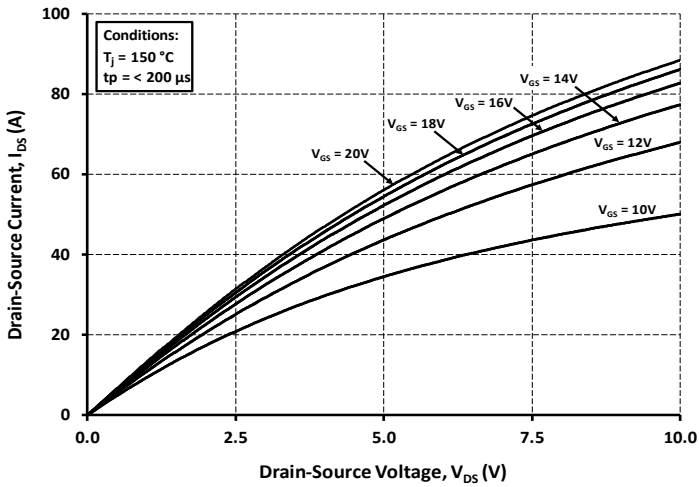

Figure 3. Output Characteristics $T_j = 150^\circ\text{C}$

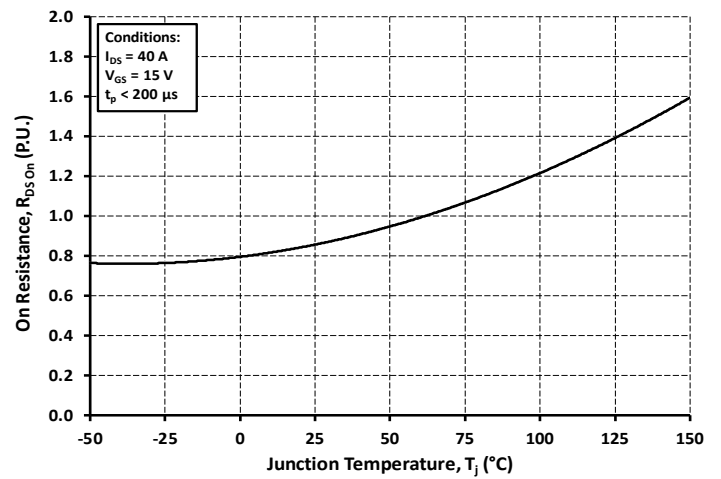

Figure 4. Normalized On-Resistance vs. Temperature

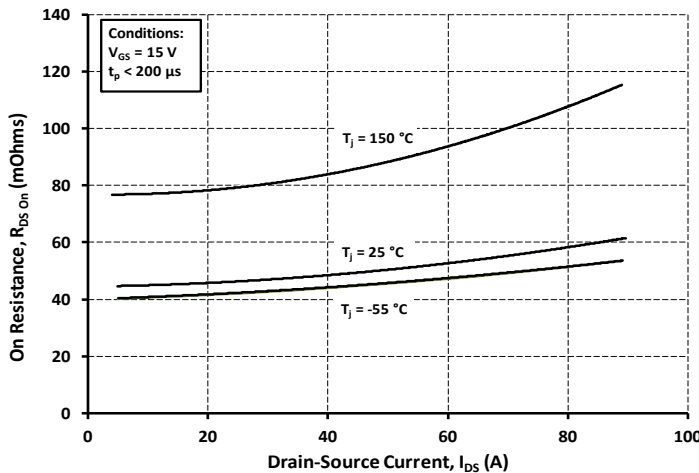

Figure 5. On-Resistance vs. Drain Current For Various Temperatures

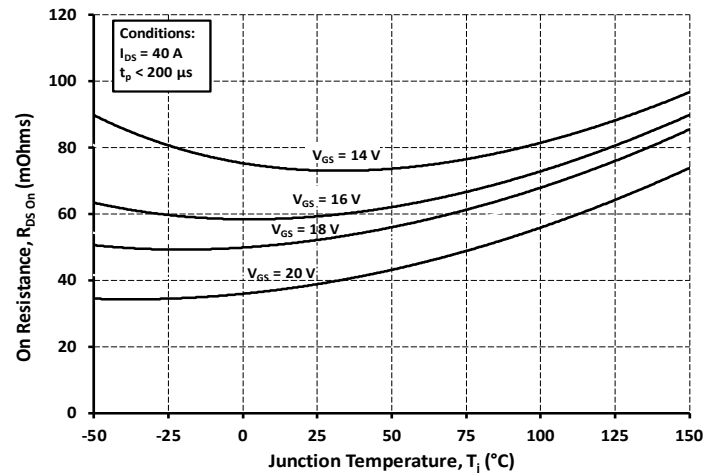

Figure 6. On-Resistance vs. Temperature For Various Gate Voltage



Typical Performance

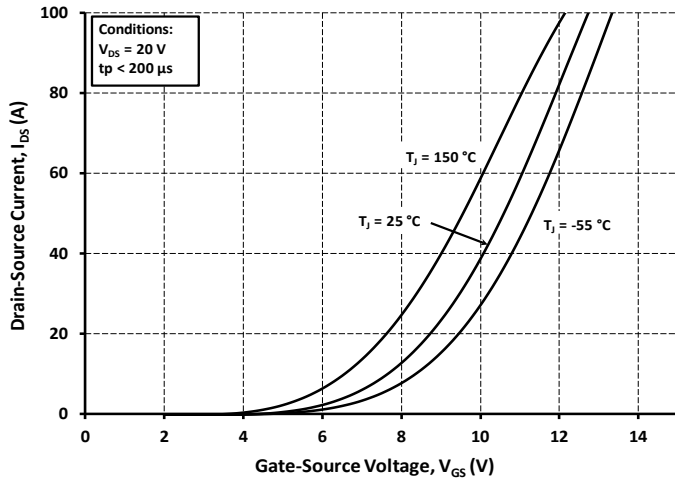

Figure 7. Transfer Characteristic for Various Junction Temperatures

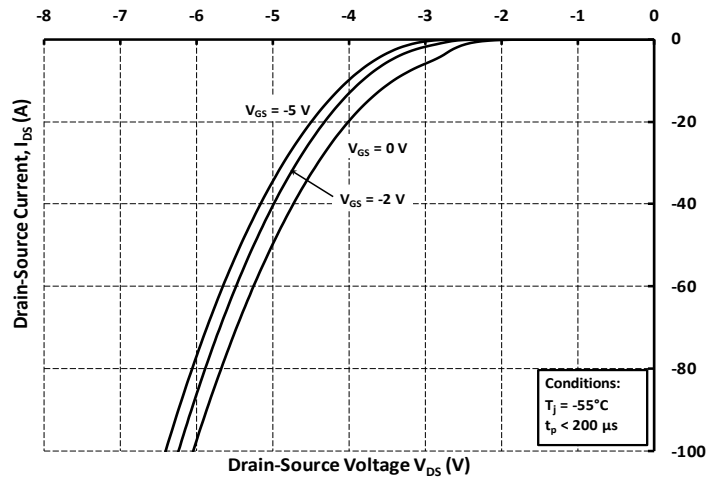

Figure 8. Body Diode Characteristic at -55 °C

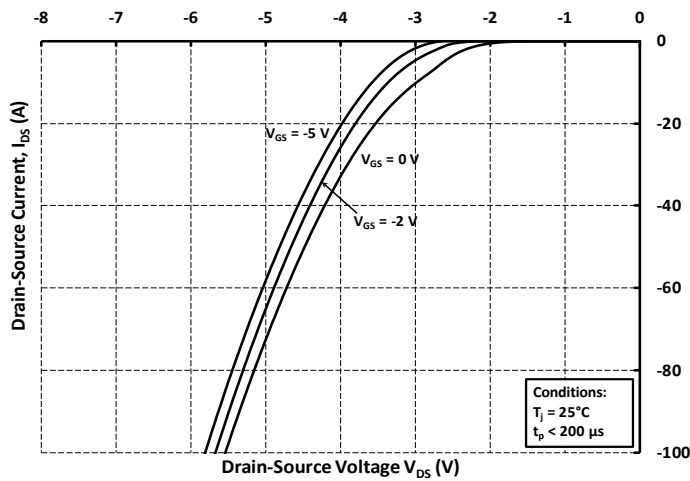

Figure 9. Body Diode Characteristic at 25 °C

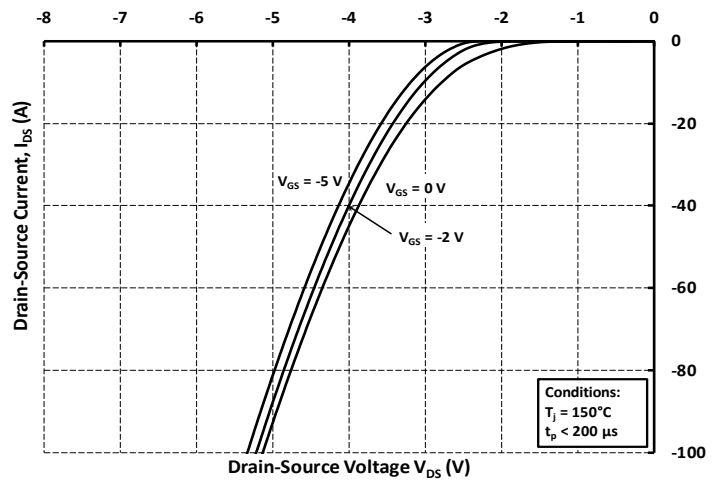

Figure 10. Body Diode Characteristic at 150 °C

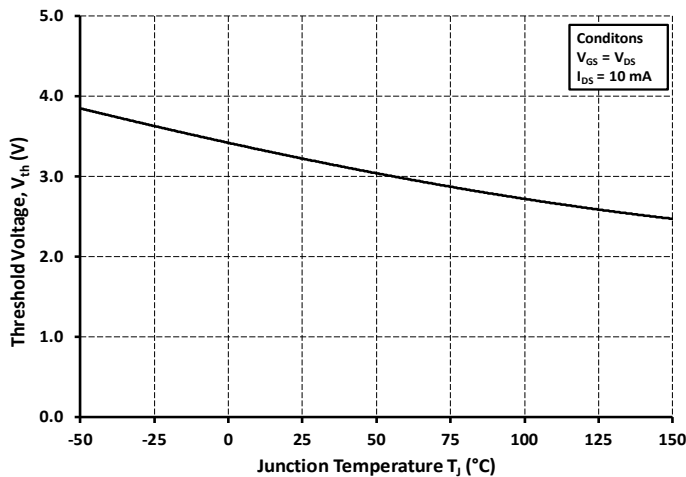

Figure 11. Threshold Voltage vs. Temperature

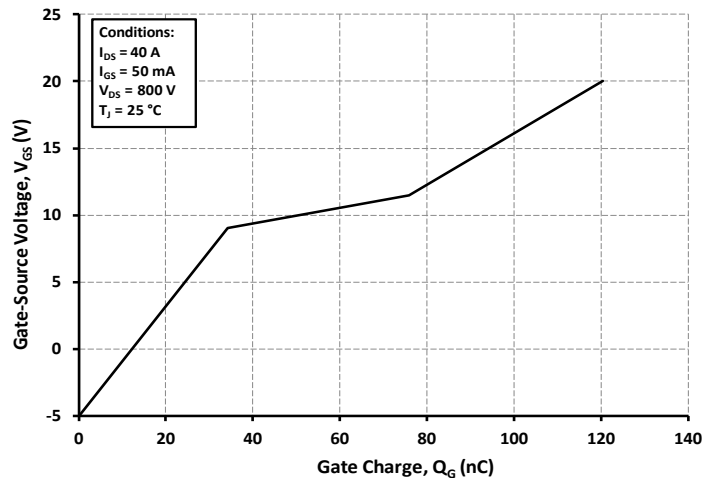

Figure 12. Gate Charge Characteristics



Typical Performance

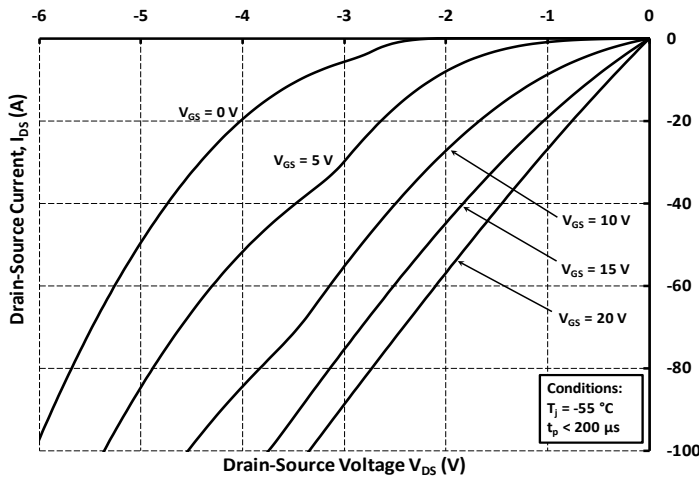

Figure 13. 3rd Quadrant Characteristic at -55 °C

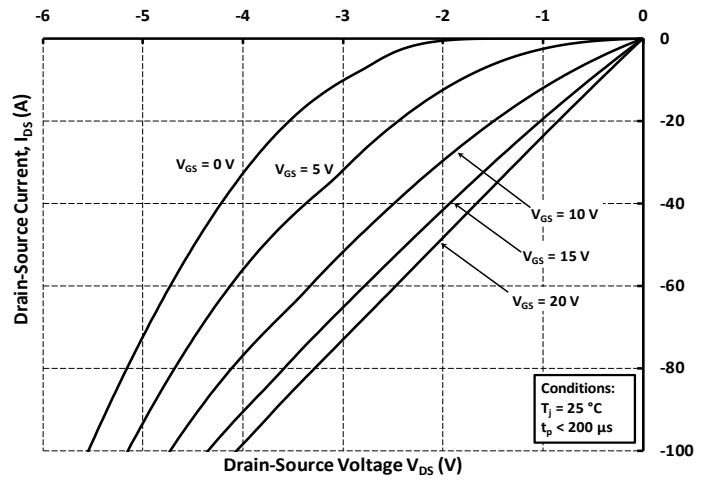

Figure 14. 3rd Quadrant Characteristic at 25 °C

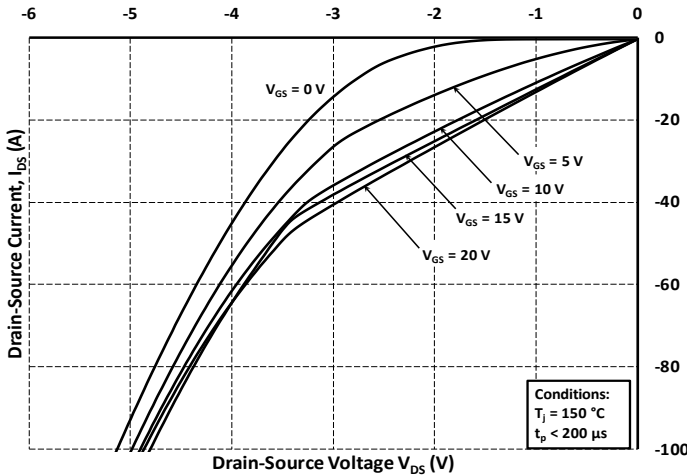

Figure 15. 3rd Quadrant Characteristic at 150 °C

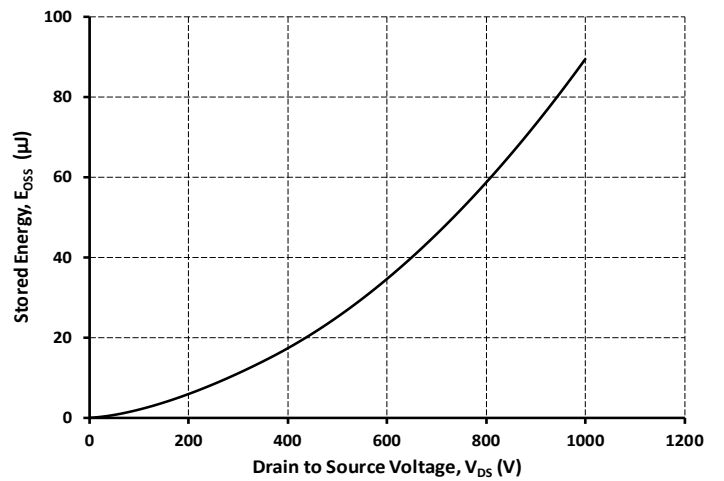

Figure 16. Output Capacitor Stored Energy

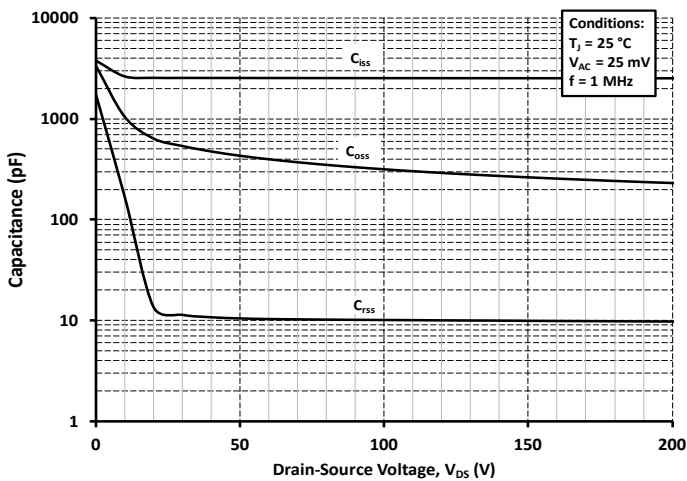

Figure 17. Capacitances vs. Drain-Source Voltage (0-200 V)

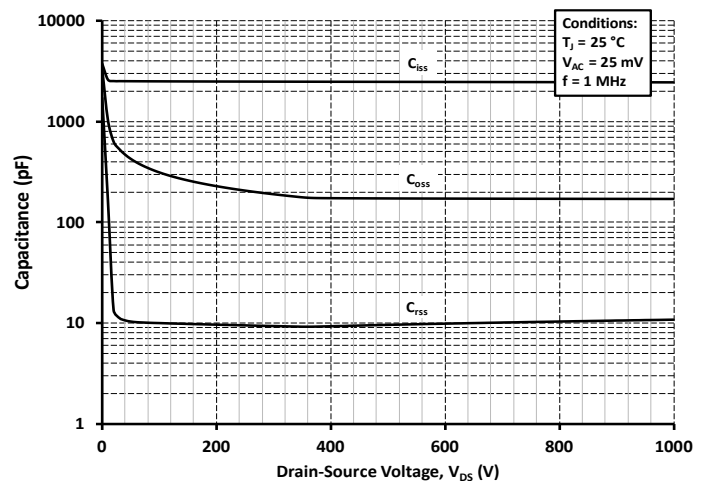

Figure 18. Capacitances vs. Drain-Source Voltage (0-1000 V)



Typical Performance

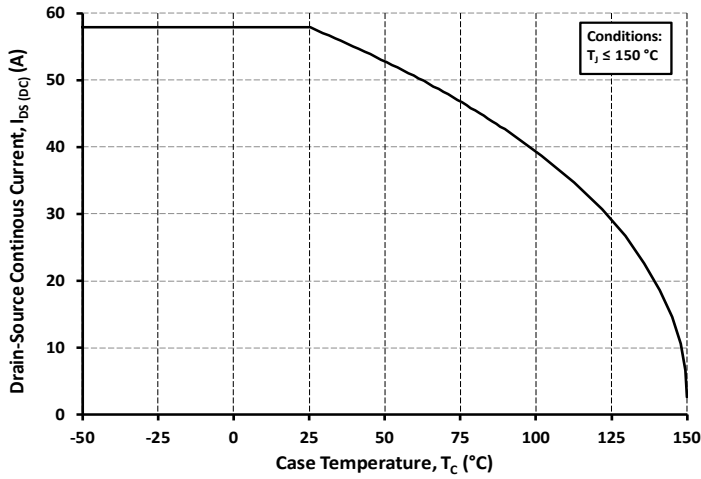

Figure 19. Continuous Drain Current Derating vs. Case Temperature

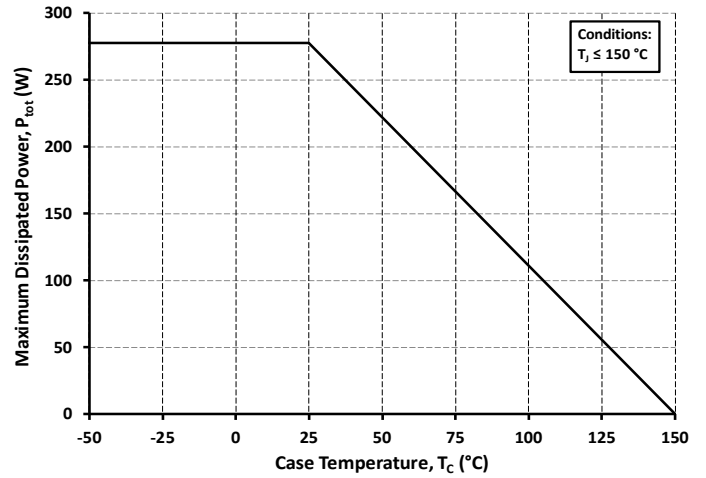

Figure 20. Maximum Power Dissipation Derating vs. Case Temperature

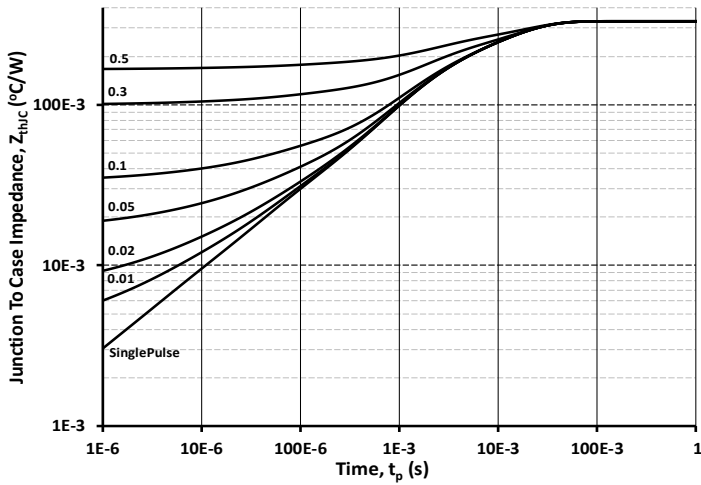

Figure 21. Transient Thermal Impedance (Junction - Case)

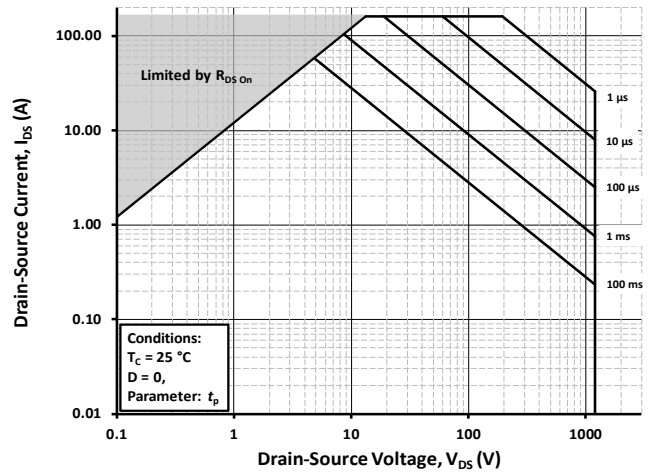

Figure 22. Safe Operating Area

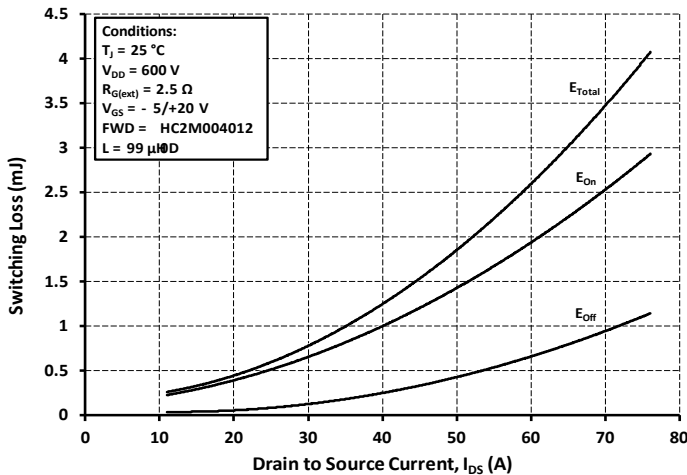

Figure 23. Clamped Inductive Switching Energy vs. Drain Current ($V_{DD} = 600V$)

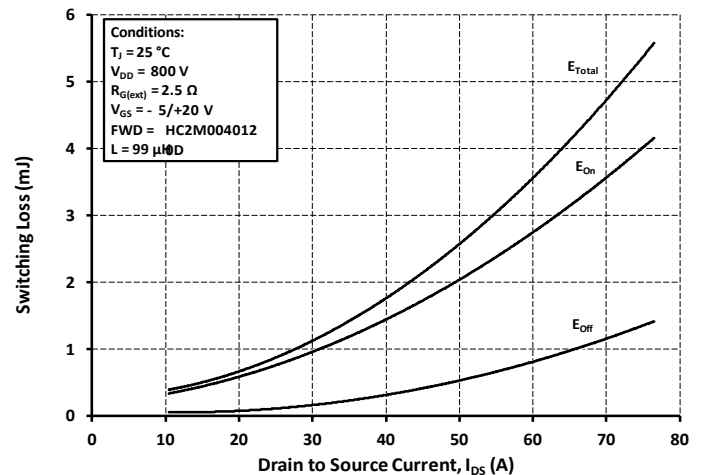

Figure 24. Clamped Inductive Switching Energy vs. Drain Current ($V_{DD} = 800V$)



Typical Performance

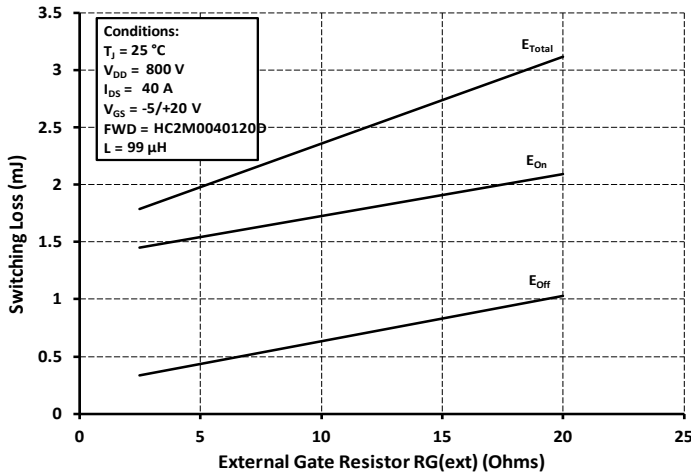

Figure 25. Clamped Inductive Switching Energy vs. $R_{G(ext)}$

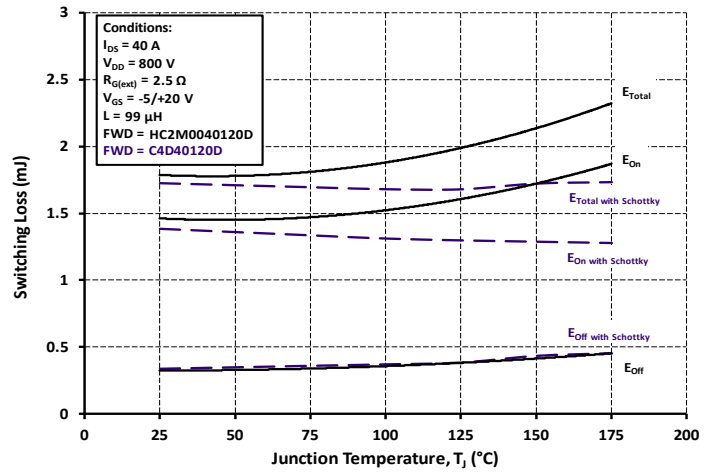

Figure 26. Clamped Inductive Switching Energy vs. Temperature

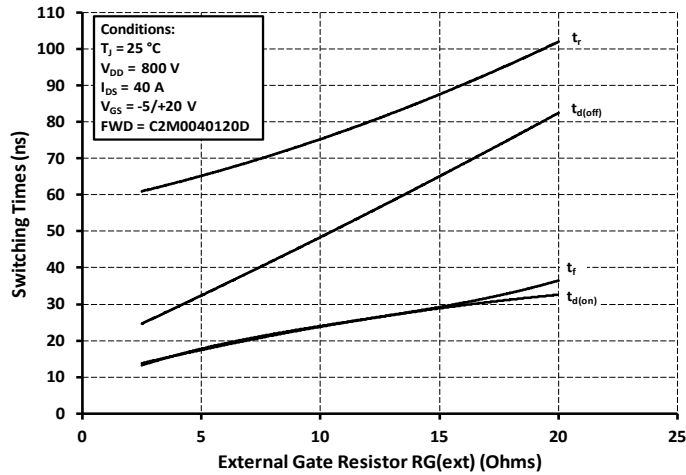

Figure 27. Switching Times vs. $R_{G(ext)}$

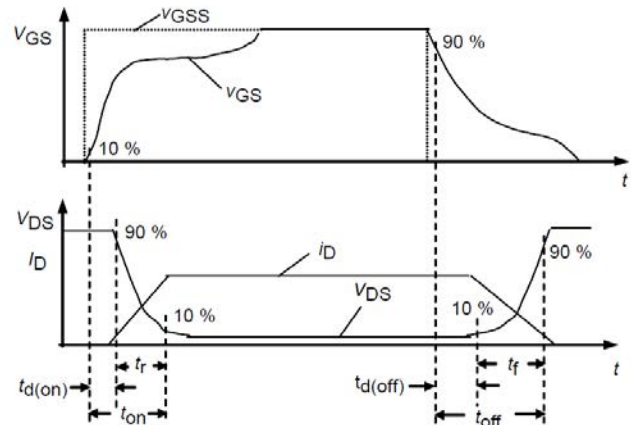

Figure 28. Switching Times Definition

IEC 1161/04



Test Circuit Schematic

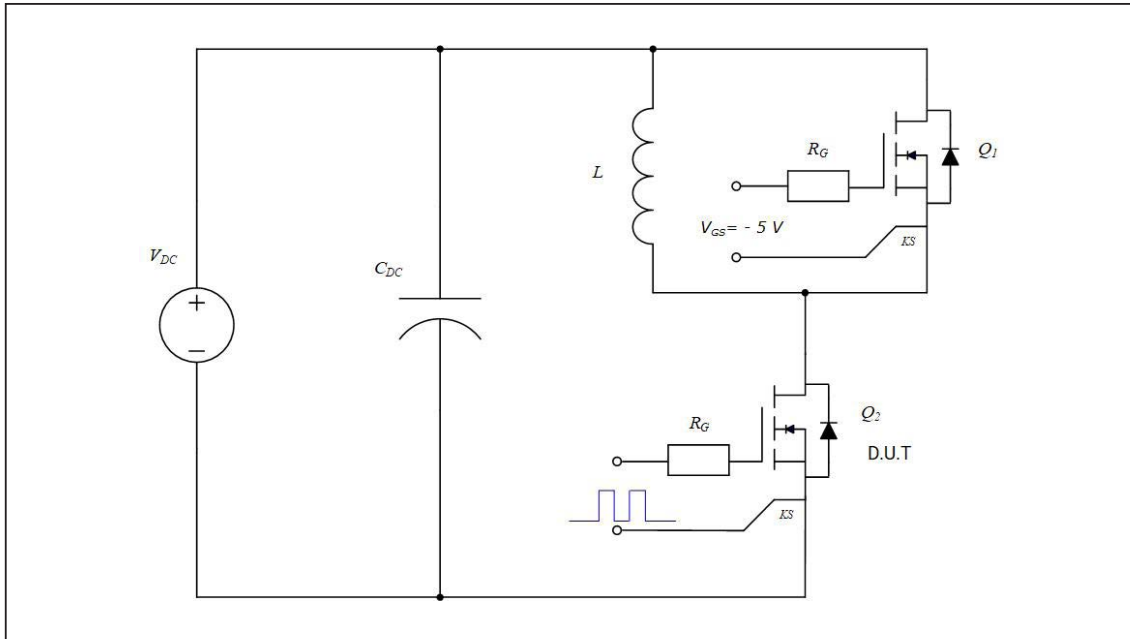

Figure 29. Clamped Inductive Switching
Waveform Test Circuit

ESD Ratings

| ESD Test | Resulting Classification |
|----------|--------------------------|
| ESD-HBM | 3A (4000V - 8000V) |
| ESD-CDM | C3 (>=1000V) |



Package Dimensions

Package T0247-3L

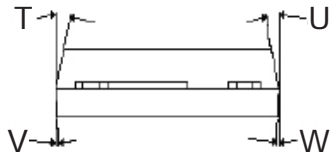
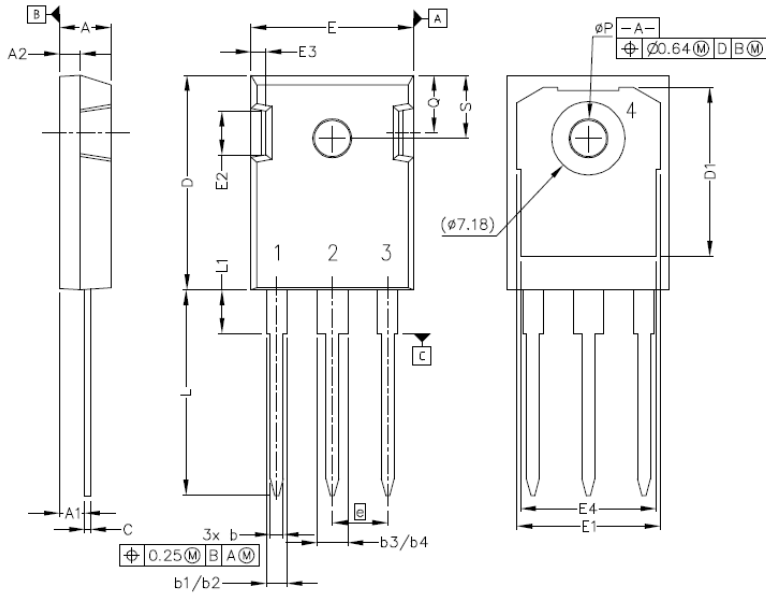

Pinout Information:

- Pin 1 = Gate
- Pin 2, 4 = Drain
- Pin 3 = Source

| POS | Inches | | Millimeters | |
|-----|----------|------|-------------|-------|
| | Min | Max | Min | Max |
| A | .190 | .205 | 4.83 | 5.21 |
| A1 | .090 | .100 | 2.29 | 2.54 |
| A2 | .075 | .085 | 1.91 | 2.16 |
| b | .042 | .052 | 1.07 | 1.33 |
| b1 | .075 | .095 | 1.91 | 2.41 |
| b2 | .075 | .085 | 1.91 | 2.16 |
| b3 | .113 | .133 | 2.87 | 3.38 |
| b4 | .113 | .123 | 2.87 | 3.13 |
| c | .022 | .027 | 0.55 | 0.68 |
| D | .819 | .831 | 20.80 | 21.10 |
| D1 | .640 | .695 | 16.25 | 17.65 |
| D2 | .037 | .049 | 0.95 | 1.25 |
| E | .620 | .635 | 15.75 | 16.13 |
| E1 | .516 | .557 | 13.10 | 14.15 |
| E2 | .145 | .201 | 3.68 | 5.10 |
| E3 | .039 | .075 | 1.00 | 1.90 |
| E4 | .487 | .529 | 12.38 | 13.43 |
| e | .214 BSC | | 5.44 BSC | |
| N | 3 | | 3 | |
| L | .780 | .800 | 19.81 | 20.32 |
| L1 | .161 | .173 | 4.10 | 4.40 |
| ØP | .138 | .144 | 3.51 | 3.65 |
| Q | .216 | .236 | 5.49 | 6.00 |
| S | .238 | .248 | 6.04 | 6.30 |
| T | 9° | 11° | 9° | 11° |
| U | 9° | 11° | 9° | 11° |
| V | 2° | 8° | 2° | 8° |
| W | 2° | 8° | 2° | 8° |

Recommended Solder Pad Layout

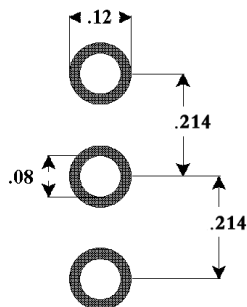

T0247-3L



Attention

- Any and all HUA XUAN YANG ELECTRONICS products described or contained herein do not have specifications that can handle applications that require extremely high levels of reliability, such as life-support systems, aircraft's control systems, or other applications whose failure can be reasonably expected to result in serious physical and/or material damage. Consult with your HUA XUAN YANG ELECTRONICS representative nearest you before using any HUA XUAN YANG ELECTRONICS products described or contained herein in such applications.

- HUA XUAN YANG ELECTRONICS assumes no responsibility for equipment failures that result from using products at values that exceed, even momentarily, rated values (such as maximum ratings, operating condition ranges, or other parameters) listed in products specifications of any and all HUA XUAN YANG ELECTRONICS products described or contained herein.

- Specifications of any and all HUA XUAN YANG ELECTRONICS products described or contained herein stipulate the performance, characteristics, and functions of the described products in the independent state, and are not guarantees of the performance, characteristics, and functions of the described products as mounted in the customer's products or equipment. To verify symptoms and states that cannot be evaluated in an independent device, the customer should always evaluate and test devices mounted in the customer's products or equipment.

- HUA XUAN YANG ELECTRONICS CO.,LTD. strives to supply high-quality high-reliability products. However, any and all semiconductor products fail with some probability. It is possible that these probabilistic failures could give rise to accidents or events that could endanger human lives, that could give rise to smoke or fire, or that could cause damage to other property. When designing equipment, adopt safety measures so that these kinds of accidents or events cannot occur. Such measures include but are not limited to protective circuits and error prevention circuits for safe design, redundant design, and structural design.

- In the event that any or all HUA XUAN YANG ELECTRONICS products(including technical data, services) described or contained herein are controlled under any of applicable local export control laws and regulations, such products must not be exported without obtaining the export license from the authorities concerned in accordance with the above law.

- No part of this publication may be reproduced or transmitted in any form or by any means, electronic or mechanical, including photocopying and recording, or any information storage or retrieval system, or otherwise, without the prior written permission of HUA XUAN YANG ELECTRONICS CO.,LTD.

- Information (including circuit diagrams and circuit parameters) herein is for example only ; it is not guaranteed for volume production. HUA XUAN YANG ELECTRONICS believes information herein is accurate and reliable, but no guarantees are made or implied regarding its use or any infringements of intellectual property rights or other rights of third parties.

- Any and all information described or contained herein are subject to change without notice due to product/technology improvement, etc. When designing equipment, refer to the "Delivery Specification" for the HUA XUAN YANG ELECTRONICS product that you intend to use.