

GLASS PASSIVATED SURFACE MOUNT BRIDGE RECTIFIERS

Features

- ◆ Glass Passivated Chip Junction
- ◆ Reverse Voltage - 100 to 1000 V
- ◆ Forward Current- 3.0 A
- ◆ Fast reverse recovery time
- ◆ Designed for Surface Mount Application

UMSB

ROHS
COMPLIANT

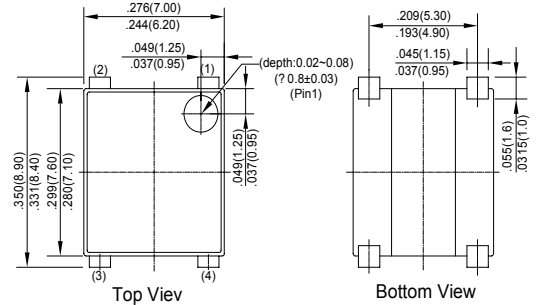

Mechanical Data

Case: JEDEC UMSB molded plastic body
 Terminals: Solderable per MIL-STD-750, Method 2026A
 Polarity: Polarity symbol marking on body
 Mounting Position: Any
 Weight: 0.00825 ounce, 0.234 grams

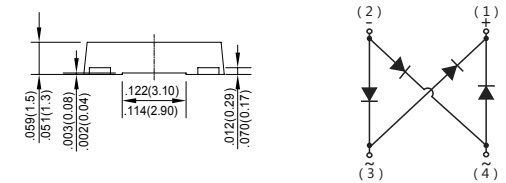

Dimensions in inches and (millimeters)

Maximum Ratings And Electrical Characteristics

Ratings at 25°C ambient temperature unless otherwise specified.

Single phase half-wave 60Hz, resistive or inductive load, for capacitive load current derate by 20%.

Parameter	Symbols	MDD	MDD	MDD	MDD	MDD	MDD	Units
		RMSB30B	RMSB30D	RMSB30G	RMSB30J	RMSB30K	RMSB30M	
Marking Code								
Maximum Repetitive Peak Reverse Voltage	V_{RRM}	100	200	400	600	800	1000	V
Maximum RMS voltage	V_{RMS}	70	140	280	420	560	700	V
Maximum DC Blocking Voltage	V_{DC}	100	200	400	600	800	1000	V
Maximum Average Forward Rectified Current	$I_{F(AV)}$	3						A
Peak Forward Surge Current 8.3 ms Single Half Sine Wave Superimposed on Rated Load (JEDEC Method)	I_{FSM}	90						A
Maximum Forward Voltage at 3.0 A	V_F	1.3						V
Maximum DC Reverse Current @ $T_a=25^\circ\text{C}$ at Rated DC Blocking Voltage @ $T_a=125^\circ\text{C}$	I_R	5.0 200						μA
Typical Junction Capacitance (Note 1)	C_j	40						pF
Typical Thermal Resistance (Note 2)	$R_{\theta JA}$ $R_{\theta JC}$ $R_{\theta JL}$	65 15 30						$^\circ\text{C/W}$
Maximum Reverse Recovery Time (Note 3)	t_{rr}	150			250	500		ns
Operating and Storage Temperature Range	T_j, T_{stg}	-55 ~ +150						$^\circ\text{C}$

Note: 1. Measured at 1MHz and applied reverse voltage of 4 V D.C.

2. Mounted on glass epoxy PC board with $4 \times 1.5 \times 1.5$ (3.81 x 3.81 cm) copper pad areas.

3. Measured with $I = 0.5 \text{ A}$, $I = 1 \text{ A}$, $I_{rr} = 0.25 \text{ A}$.

Typical Characteristics

Fig.1 Average Rectified Output Current Derating Curve

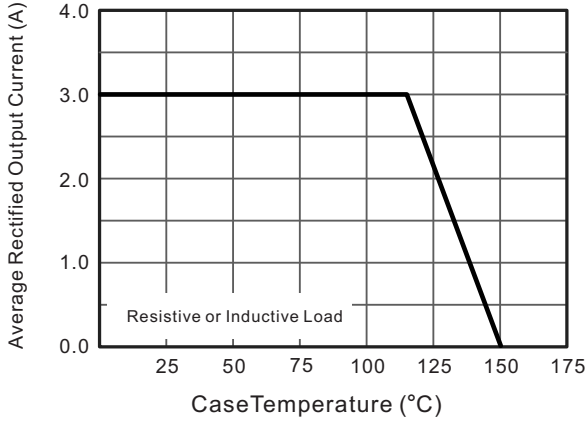

Fig.2 Typical Reverse Characteristics

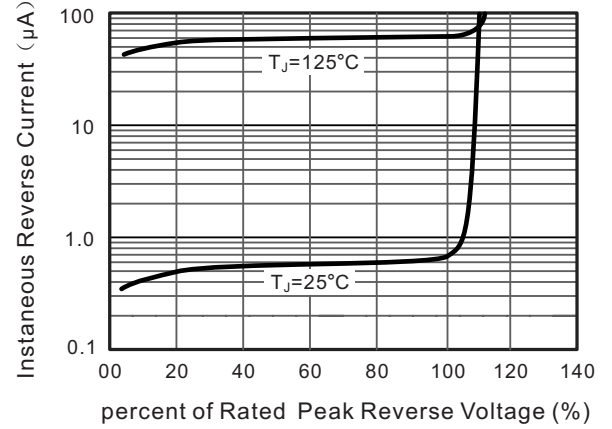

Fig.3 Typical Instantaneous Forward Characteristics

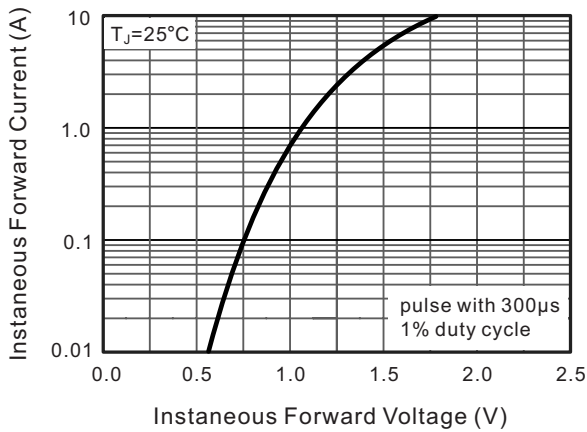

Fig.4 Typical Junction Capacitance

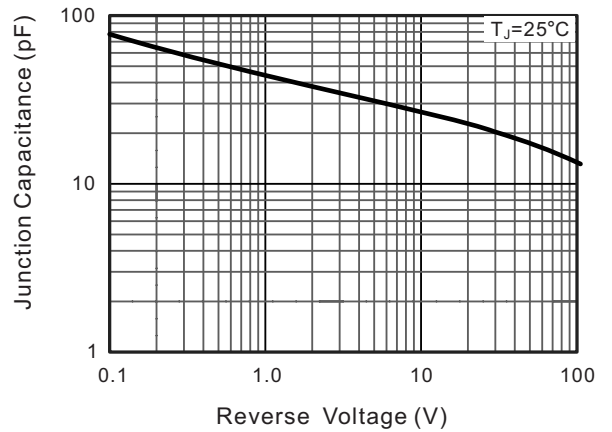

Fig.5 Maximum Non-Repetitive Peak Forward Surge Current

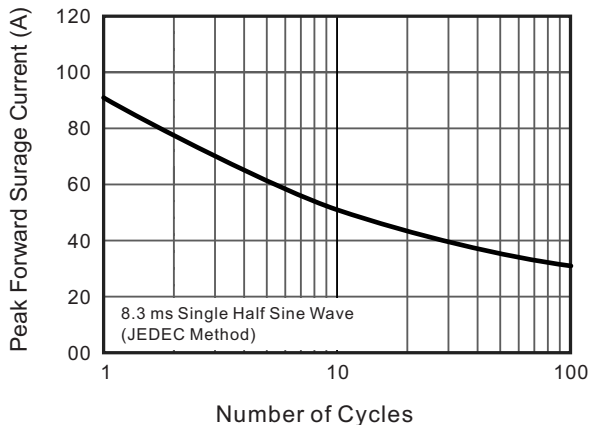
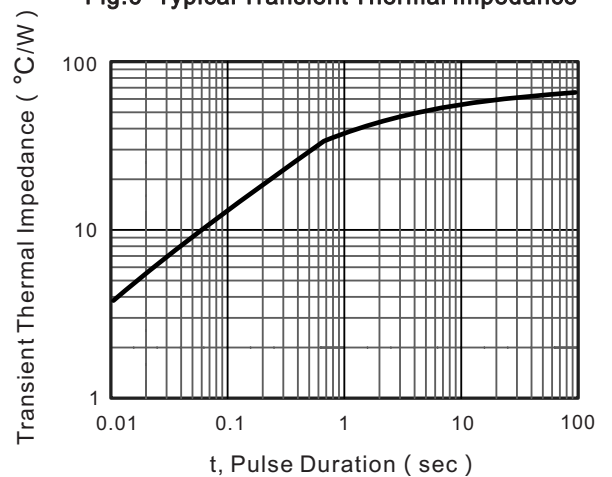
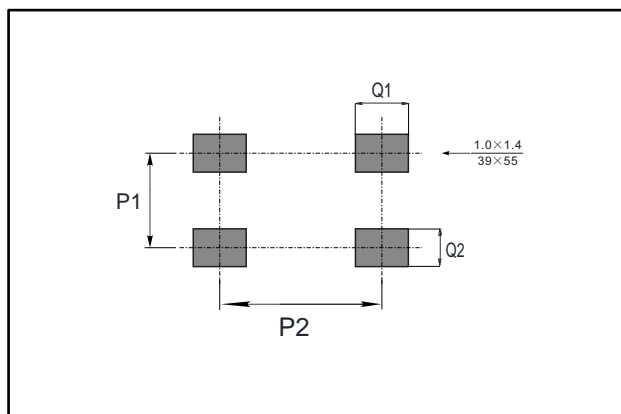

Fig.6 Typical Transient Thermal Impedance



The curve above is for reference only.

Suggested Pad Layout



Dim	Min
P1	5.1
P2	7.1
Q1	1.8
Q2	1.3