

SAMZO REAC/ROHS

REV	ECN NO	DESCRIPTION	DESIGN	APPROVAL	DATE
A1	NEW	Replace frame			2018.06.12

主要技术参数、性能
The Main Thchnology Performance

额定电流、电压 Rate voltage, current	50mA DC12V
接触电阻 Contact resistance	≤100mΩ
按力 Operating force	±60gf
行程 Travel	0.35±0.15mm
绝缘电阻 Insulated resistance	≥100MΩ
介电强度 Dielectric strength	≥250VAC/1min

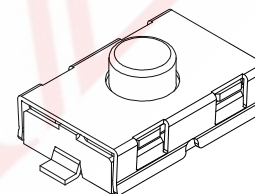
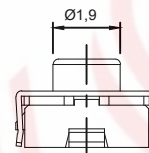
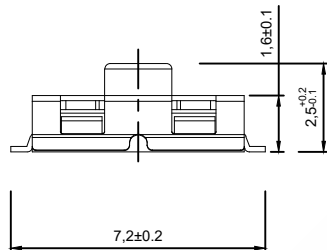
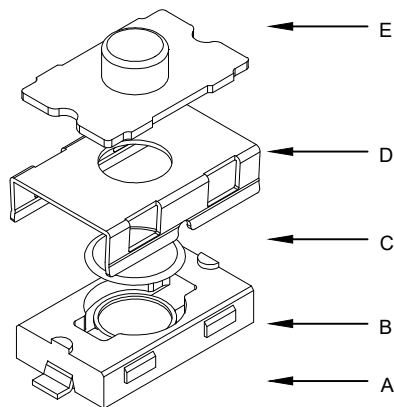

Y 4 A 2 5 * 1 1 0 *

(A) (B) (C) (D) (E) (F) (G) (H) (I)

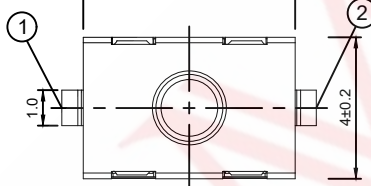

- A. 系列:Y-4*6系列
- B. 贴装方式:4-立贴贴片
- C. 引脚规格:A-2P
- D. 操作高度:25-2.5mm
- E. 操作力度:1-180/2-260gf
- F. 操作寿命:1-10,000次
- E. G. 固定方式:1-不带住
- H. 物料编码:0-常规
- I. 接触方式:K-常开/B:常闭

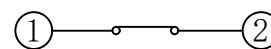

电路图
CIRCUIT DIAGRAM

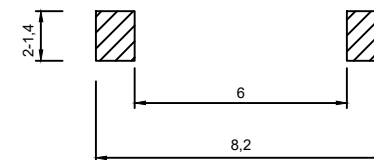

PCB. 焊接图
PCB. WELDING DRAWING

ITEM	DESCRIPTION	MATERIAL	QTY	FINISH/COLOR					
E	按钮	硅胶	1	蓝色	GENERAL TOLERANCE				
D	盖板	不锈钢	1	清洗	≥0~2<	±0.15			
C	弹片	不锈钢	1	镀银	DESIGN	WANGGUIFA	2018.06.12	≥2~5<	±0.25
B	本件	PPA	1	黑色	CHECKED	ZHENGUILAN	2018.06.12	≥0~2<	±0.15
A	卡件	黄铜	1	镀银	APPROVED	LILIANJIANG	2018.06.14	≥5	±0.35

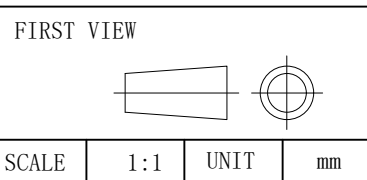

The copyright belongs to samzo parts [China] Co., Ltd. please use the material after samzo parts agree to authorize. The final right of interpretation belongs to samzo parts. WWW.KKK-JP.COM

SAMZO COMPONENTS
Electronic switch and connector manufacturer

TITLE::	4*6*2.5蓝色硅胶 2P-常闭
DWG NO:	Y4A25-P30
PART NO:	Y4A253176
MODEL NO:	Y4A25-* -110-*
NAME:	TACT SWITCH