

Typical Specifications

Items	Specifications	
	RK10J	RK14J
Total resistance tolerance	±30%	
Maximum operating voltage	50V AC, 20V DC (Single-unit only)	
Total rotational angle	270° ± 10°	270° ± 5°
Rotational torque	0.5 to 10mN·m	1 to 10mN·m
Operating life	10,000 cycles	
Operating temperature range	-10°C to +60°C	-25°C to +70°C

Product Line

Type	Number of resistor elements	Knob type	Total resistance (k Ω)	Resistance taper	Soldering	Mounting type	For DC use	Minimum order unit (pcs.)		Products No.	Drawing No.							
								Japan	Export									
10mm Size	Single-unit	Knob diameter : φ 14 Knob thickness : t0.9 Color : Black	10	1B	Manual	Insertion (2mm)	20V DC	3,000	2,400	RK10J11E0034	1							
			20	3B						RK10J11E002Y								
	Dual-unit		10	15A			Not applicable			RK10J12E0A0A								
			20	15C						RK10J12E002L								
	10mm Size		Single-unit	Knob diameter : φ 14 Knob thickness : t1.0 Color : Black			10			15A		Reflow	Surface mounting	20V DC	3,000	3,000	RK10J11R001Y	2
										3B							RK10J11R0A0H	
Dual-unit		15A	Not applicable		RK10J12R0A0B													
		15C			RK10J12R0052													
14mm Size	Single-unit	Knob diameter : φ 15 Knob thickness : t0.9 Color : Black	10	1B	Manual/ Dip	Insertion (2mm)	20V DC	1,200	2,400	RK14J11A000G	3							
			50	3B						RK14J11A0A02								
			100	1B						RK14J11A0007								
	Dual-unit		20	15C			Not applicable			RK14J12A0A0U								
			50	3B						RK14J12A0A0K								
			10	1B						Reflow		Surface mounting	20V DC	3,000	3,000	RK14J11R000J	4	
	Single-unit		50	3B	RK14J11R000H													
			Dual-unit	10	15A	Not applicable	RK14J12R0A01											
					3B		RK14J12R0A0C											
	15C				RK14J12R0A09													

Notes

- Other varieties are also available. Refer to "Other Specifications" (P.391,392).
- Dip soldering can be applied to RK14J. For dip soldering applications, specify separately as "dip soldering applicable product".

Refer to P.391 for other specifications.
Refer to P.393 for ordering products not listed.
Refer to P.394 for soldering conditions.

RK10J RK14J With Knob Type

Packing Specifications (RK10J)

Bulk / Taping

Soldering	Packing specifications	Number of packages (pcs.)			Tape width (mm)	Export package measurements (mm)
		1 reel	1 case /Japan	1 case /export packing		
Manual	Bulk	—	3,000	2,400	—	250×371×190
Reflow	Taping	1,000	3,000	3,000	24	397×401×139

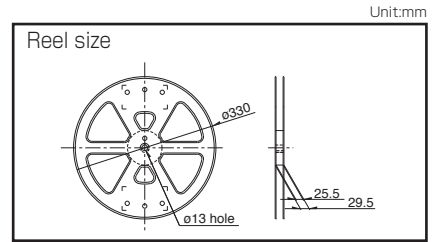

Packing Specifications (RK14J)

Bulk / Taping

Soldering	Packing specifications	Number of packages (pcs.)			Tape width (mm)	Export package measurements (mm)
		1 reel	1 case /Japan	1 case /export packing		
Manual	Bulk	—	1,200	2,400	—	259×379×206
Reflow	Taping	1,000	3,000	3,000	24	397×401×139

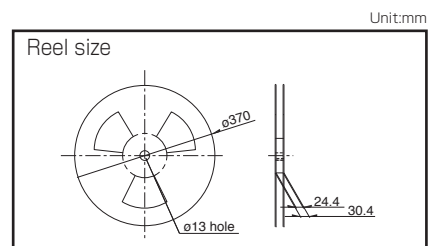

Dimensions

No.	Photo	Style	PC board mounting hole dimensions (Viewed from mounting side)
1			
2			
3			

■ Dimensions

Unit:mm

No.	Photo	Style	PC board mounting hole dimensions (Viewed from mounting side)
4			

■ Circuit Diagram

Single-unit	Dual-unit	Dual-unit resistance taper 15C

With Knob Type / Other Specifications

In addition to the products listed, we can accommodate the follow specifications.

■ Total Resistance Variety

Total resistance (k Ω)	10	20	50	100

■ Resistance Taper

Resistance taper	15A	1B	3B	15C

■ Terminal Layout

	Resistance taper A or B		Resistance taper C	
	Single-unit	Dual-unit	Single-unit	Dual-unit
10mm Single-unit/ Dual-unit RK10J1□E				
10mm Single-unit/ Dual-unit RK10J1□R (Reflow-type)				
14mm Single-unit/ Dual-unit RK14J1□A RK14J1□R				

Refer to P.393 for ordering products not listed.

■ Mounting Plate Types and Terminal Types

Unit:mm

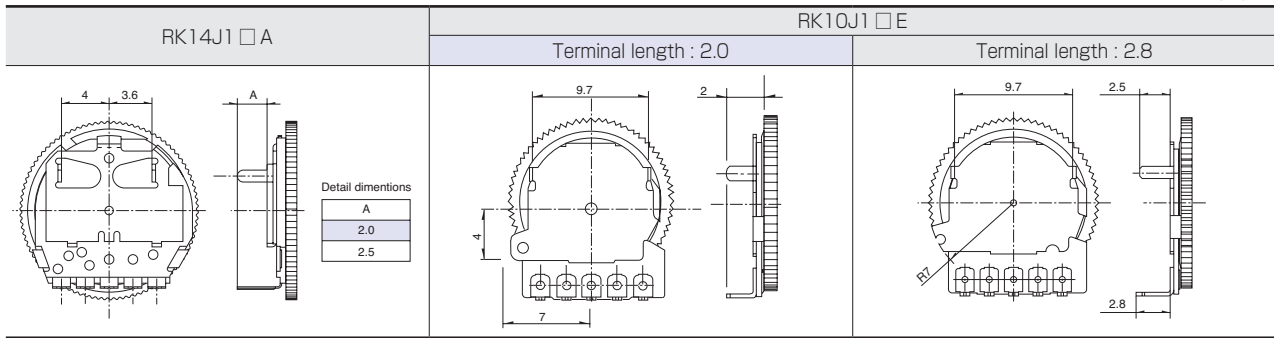

■ Knob Variety

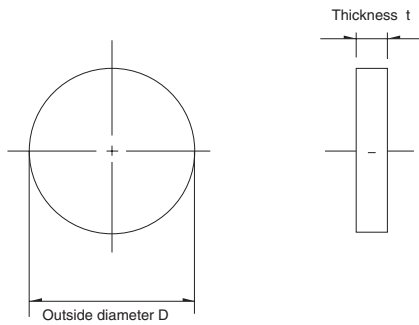

Applicable models	Knob variety			Body thickness (mm)
	Type	Outer diameter D	Thickness (mm)	
RK10J11E RK10J12E	K4	$\phi 14$	0.9	Black
	K5	$\phi 16$	3.0	
RK10J11R RK10J12R (Reflow-type)	K1	$\phi 14$	1.0	Black
	K2	$\phi 14$	2.5	
	K3	$\phi 16$		
RK14J11A RK14J12A	K1	$\phi 15$	0.9	Black
	K2	$\phi 15$	3.0	
	K3	$\phi 18$		
RK14J11R RK14J12R (Reflow-type)	K1	$\phi 15$	0.9	Black
	K2	$\phi 15$	3.0	

Note

Marked are specifications recommended by ALPS.

With Knob Type / Ordering Products Not Listed

When ordering product varieties that are not listed, specify referring to the examples below.

Sample Part Number

R K 1 4 J 1 1 A - **K 1** - **B 2 0 3**

Model type

Code	Model type
RK10J11E	10mm size single-unit Insertion type
RK10J12E	10mm size dual-unit Insertion type
RK10J11R	10mm size single-unit Reflow type
RK10J12R	10mm size dual-unit Reflow type
RK14J11A	14mm size single-unit Insertion type
RK14J12A	14mm size dual-unit Insertion type
RK14J11R	14mm size single-unit Reflow type
RK14J12R	14mm size dual-unit Reflow type

Shaft type (Outer diameter/Thickness) (mm)

Code	RK10J1□E	RK10J1□R	RK14J1□A	RK14J1□R
K1	—	V14 t1.0	V15 t0.9	V15 t0.9
K2	—	V14 t2.5	V15 t3.0	V15 t3.0
K3	—	V16 t2.5	V18 t3.0	—
K4	V14 t0.9	—	—	—
K5	V16 t3.0	—	—	—

*Color : Black

Resistance taper

Code	Resistance taper	Code	Resistance taper
A	15A	C	15C
B	1B	V	3B

B: For tone & general
V: For vol.

Total resistance

Code	Total resistance (k Ω)	Code	Total resistance (k Ω)
103	10	503	50
203	20	104	100

Note

Marked are specifications recommended by ALPS.

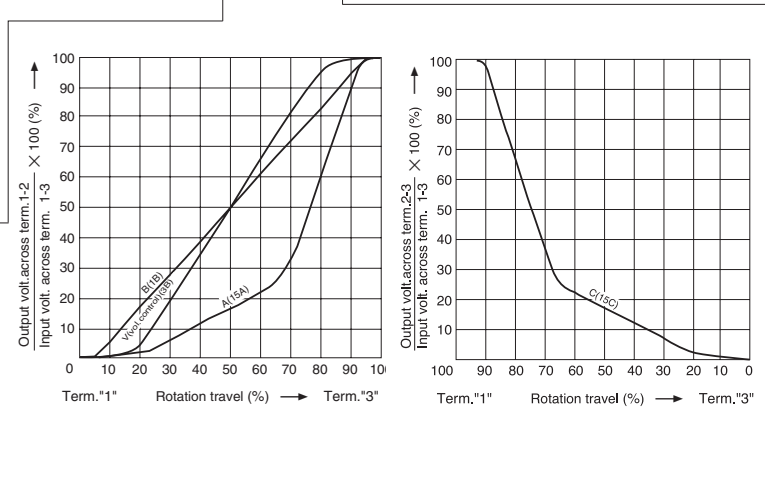

Rotary Potentiometers

Slide Potentiometers

Metal Shaft











Insulated Shaft

Knob Operating

Ring Type

Knob Operating Type Potentiometers

List of Varieties

Type	Without knob type			With knob type				
Series	RK08H1 □ 1	RK08H1 □ 2	RK08H1 □ 3	RK10J1 □ E	RK10J1 □ R	RK14J1 □ A	RK14J1 □ R	
	Single-unit/Dual-unit	Single-unit/Dual-unit	Single-unit/Dual-unit	Single-unit/Dual-unit	Single-unit/Dual-unit	Single-unit/Dual-unit	Single-unit/Dual-unit	
Photo								
Terminal orientation	Vertical	Back-to-back mounting	Reflow type	—	—	—	—	
Operating temperature range	-10°C to +60°C					-25°C to +70°C		
Operating life	Without detent 10,000 cycles With detent 5,000 cycles			10,000 cycles				
Automotive use	—	—	—	—	—	—	—	
Life cycle								
Electrical performance	Total resistance (k Ω)	5, 10, 20, 50, 100		10, 20, 50, 100				
	Resistance taper	15A, 1B, 3B, 15C						
	Rated power	0.03W						
	Insulation resistance	—	—	—	100MΩ min. 100V DC			
	Voltage proof	—	—	—	100V AC for 1minute			
Mechanical performance	Detent	Without / Center detent			Without			
	Stopper strength	0.1N			70mN·m			
	Push-pull strength	10N			5N			
	Vibration	—	—	—	—	—	※	
Terminal style	Insertion		Reflow	Insertion	Reflow	Insertion	Reflow	
Page	385			389				

Residual Resistance

※ Applies only to products with specified residual resistance

Nominal total resistance	※ Residual resistance
100kΩ ≥ R ≥ 50kΩ	0.1% or less of nominal total resistance
50kΩ > R > 10kΩ	30Ω or less
10kΩ ≥ R	20Ω or less

Maximum Attenuation

Nominal total resistance	Maximum attenuation
R ≥ 100kΩ	90dB min.
100kΩ > R ≥ 50kΩ	80dB min.
50kΩ > R ≥ 10kΩ	70dB min.
10kΩ > R	60dB min.

Knob Operating Type Potentiometers Soldering Conditions	394
Potentiometers Cautions	439
Potentiometers Measurement and Test Methods	441
Potentiometers Resistance Taper	443

※10 to 55 to 10Hz/min., the amplitude is 1.5mm for all the frequencies, in the 3 direction of X, Y and Z for 2 hours respectively

Knob Operating Type Potentiometers / Soldering Conditions

Reference for Manual Soldering

Series	Tip temperature	Soldering time	No. of solders
RK08H1□1, RK08H1□2, RK10J, RK14J	350°C max.	3s max.	1 time

Reference for Dip Soldering

Series	Preheating		Dip soldering		No. of solders
	Soldering surface temperature	Heating time	Soldering temperature	Soldering time	
RK14J1□A	80 to 120°C	70±30s	260°C±5°C	4±1s	1 time

Example of Reflow Soldering Condition

Temperature profile

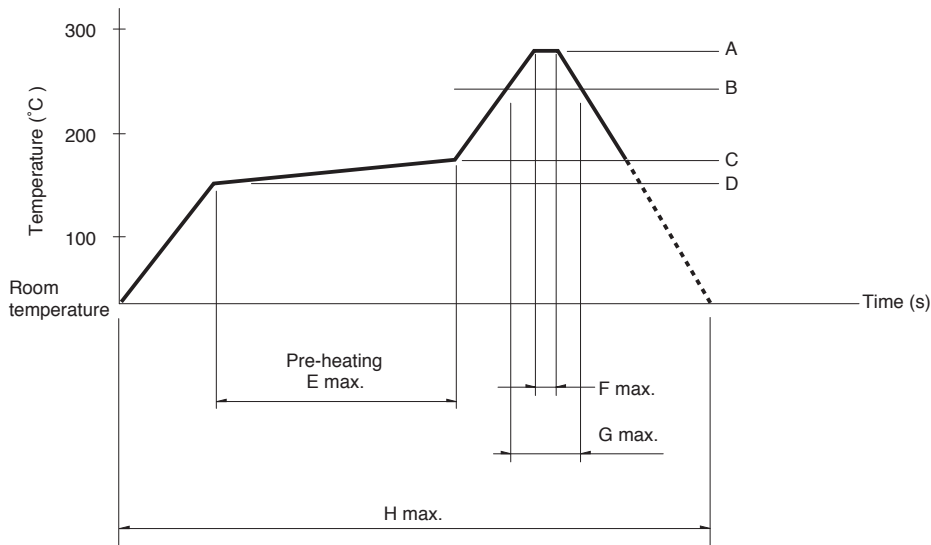

Series	A	B	C	D	E	F	G	H	No. of reflows
RK08H1□3, RK10J1□R, RK14J1□R	250°C	200°C	150°C	150°C	2 min.	3s	40s	4 min.	2 time max.

Notes

1. When using an infrared reflow oven, solder may sometimes not be applied. Be sure to use a hot air reflow oven or a type that uses infrared rays in combination with hot air.
2. The temperatures given above are the maximum temperatures at the terminals of the potentiometer when employing a hot air reflow method. The temperature of the PC board and the surface temperature of the potentiometer may vary greatly depending on the PC board material, its size and thickness. Ensure that the surface temperature of the potentiometer does not rise to 250°C or greater.
3. Conditions vary to some extent depending on the type of reflow bath used. Be sure to give due consideration to this prior to use.