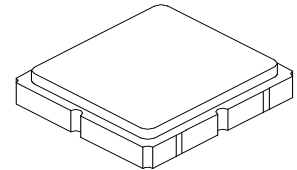

SF1186B-2
**1575.42 MHz
SAW Filter**

SM3030-6

- **Designed for Front-end GPS Applications**
- **Low Insertion Loss**
- **3.0 x 3.0 x 1.3 mm Surface-mount Case**
- **No Matching Network Required**
- **Complies with Directive 2002/95/EC (RoHS)**
- **Qualified per AEC-Q200 requirements**

Maximum Ratings

Rating	Symbol	Value	Units
Maximum Input Signal Level		+10	dBm
DC Voltage on any Non-ground Terminal	WVdc	4	Volts
Operable Temperature Range		-45 to +125	°C
Storage Temperature Range	T _{STG}	-40 to +105	°C
Lead Soldering Temperature for 10 Seconds	T _{WAVE}	260	°C
Peak Reflow Solder Temp for 40 Seconds	T _{Reflow}	235	°C
Suitable for Lead-free Soldering - Max Soldering Temperature		260°C for 30 s	

Electrical Characteristics

Characteristic	Sym	Notes	Min	Typ	Max	Units
Center Frequency	f _O	1		1575.42		MHz
1 dB Bandwidth	BW ₁	1	2.046	15.3		MHz
Passband Amplitude Ripple, f _O ±2.0 MHz				0.1	1.0	dB _{P-P}
Passband Group Delay				27		ns
Passband Group Delay Ripple, f _O ±2.0 MHz				1		ns _{P-P}
Passband VSWR, f _O ±2.0 MHz				1.4	2.0	
Insertion Loss		1		2.68	3.5	dB
Attenuation Referenced to 0 dB:						
850 MHz		1	45	51.2		dB
1500 MHz		1	40	52.7		
1535.42 MHz		1	20	38.9		
1615.42 MHz		1	20	58.8		
1640 MHz		1	45	59.1		
1700 MHz		1	50	56.7		
Temperature Coefficient			-30			ppm/°C
Operating Temperature	T _A	1	-40		+85	°C
Single-ended Input /Output Impedance Match	No matching network required for operation at 50 ohms					
Case Style	SM3030-6 3 x 3 mm Nominal Footprint					
Lid Symbolization	y=year, ww=week, s=shift	468 YWWS				
Standard Reel Quantity	Reel Size 7 Inch	6	500 Pieces/Reel			
	Reel Size 13 Inch		3000 Pieces/Reel			

Electrical Connections

Pin #	Description	Pin #	Description
1	Ground	4	Ground
2	Input	5	Output
3	Ground	6	Ground

CAUTION: Electrostatic Sensitive Device. Observe precautions for handling.
NOTES:

1. Unless noted otherwise, all specifications apply over the operating temperature range with filter soldered to the specified demonstration board without impedance matching and measured with 50 Ω network analyzer.
2. The design, manufacturing process, and specifications of this filter are subject to change.
3. Either Port 1 or Port 2 may be used for either input or output in the design. However, impedances and impedance matching may vary between Port 1 and Port 2, so that the filter must always be installed in one direction per the circuit design.
4. US and international patents may apply.
5. Murata, stylized Murata logo, and Murata N.A., Inc. are registered trademarks of Murata Manufacturing Co., Ltd.
6. Tape and Reel Standard Per ANSI/EIA 481.

Transfer function :

(1) S21 response (span : 300 MHz)

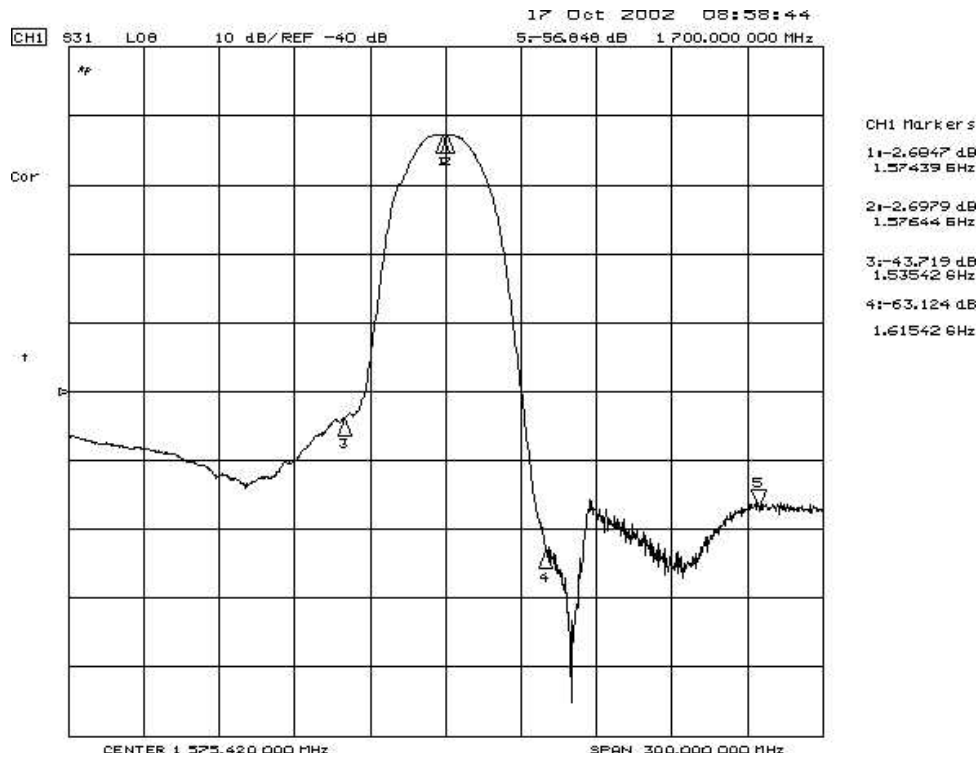

(2) S21 response (span : 3 GHz)

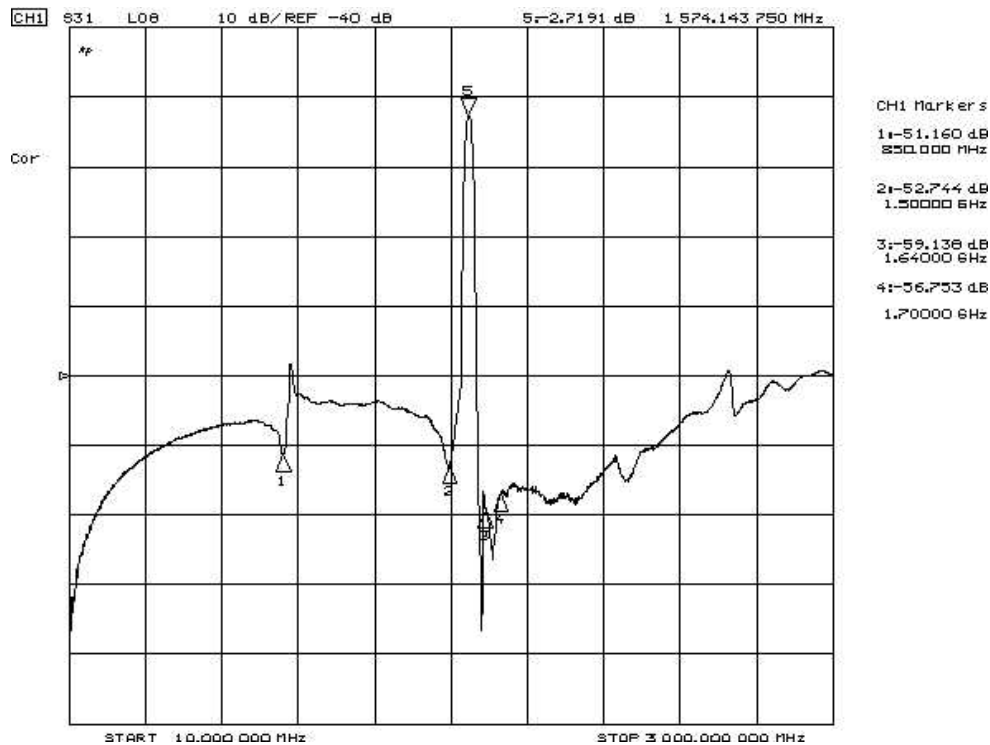

Reflection Functions:

S11

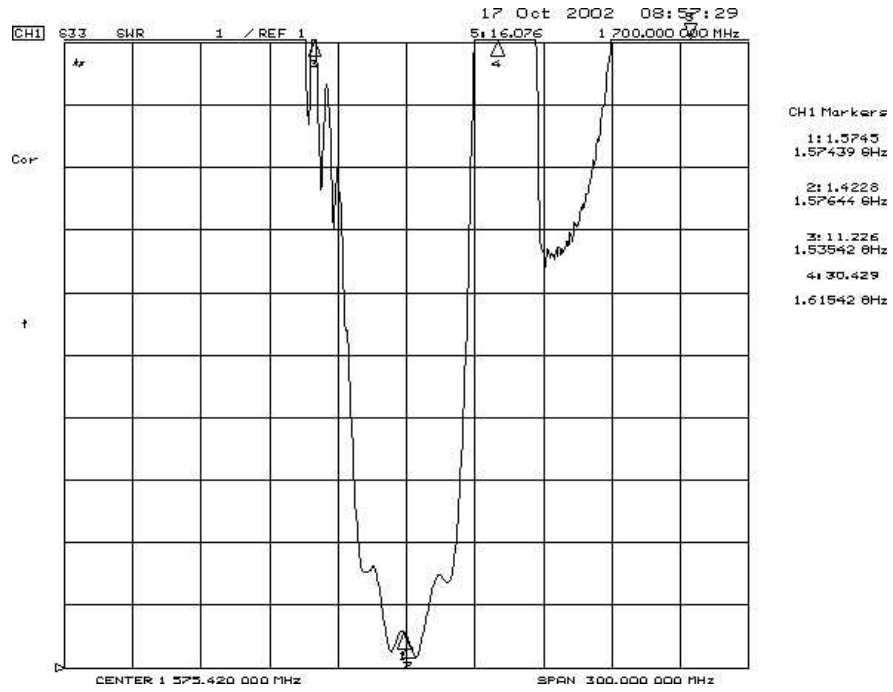

S22

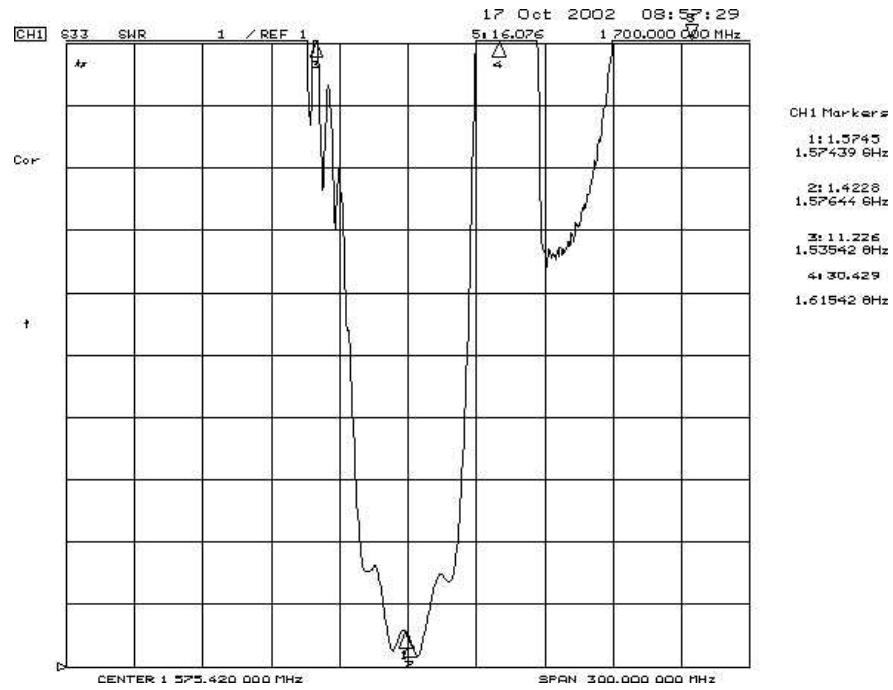

Reflection Functions:

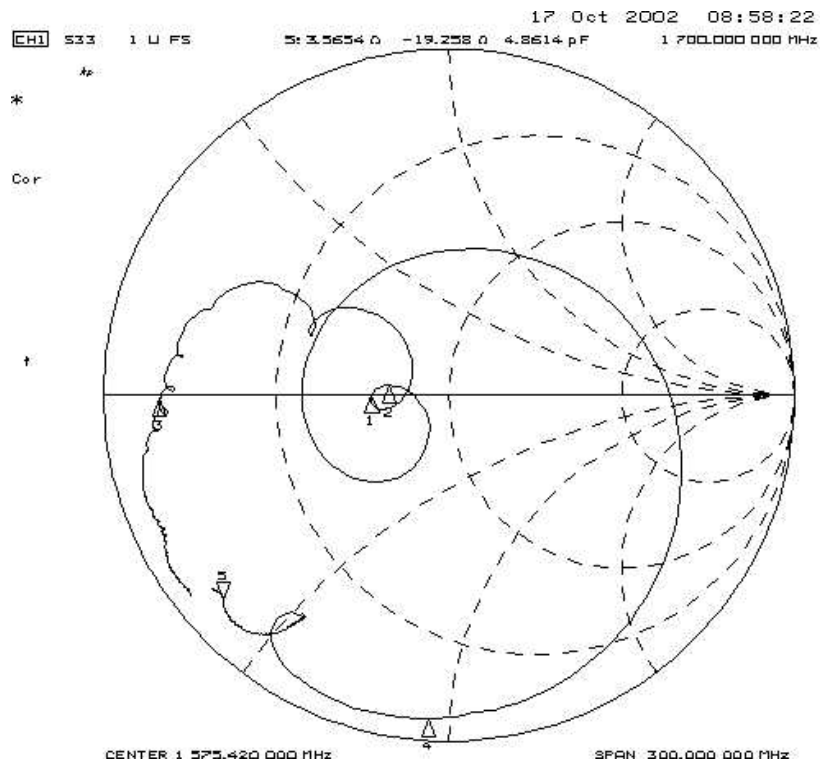
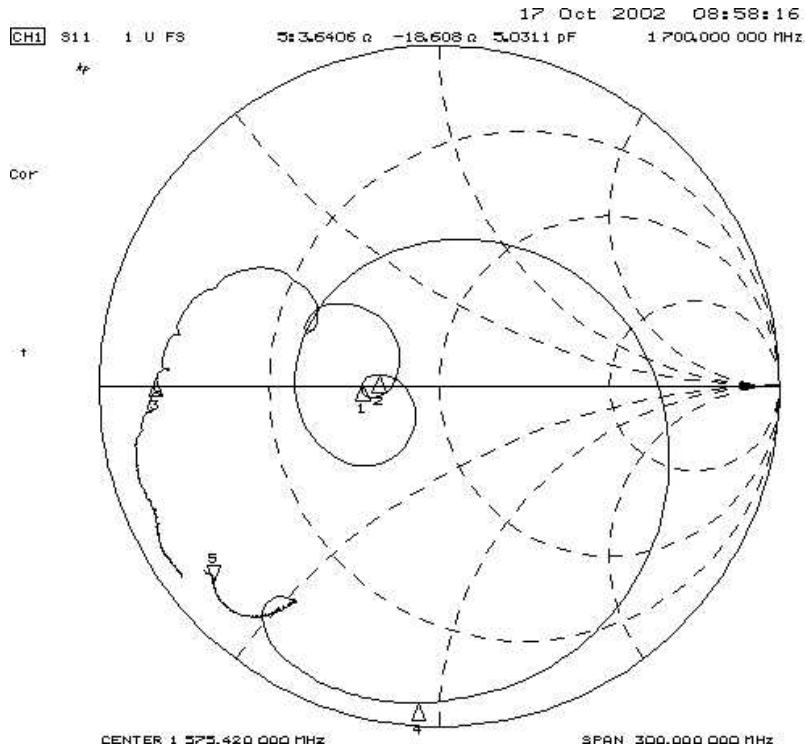

Group Delay:

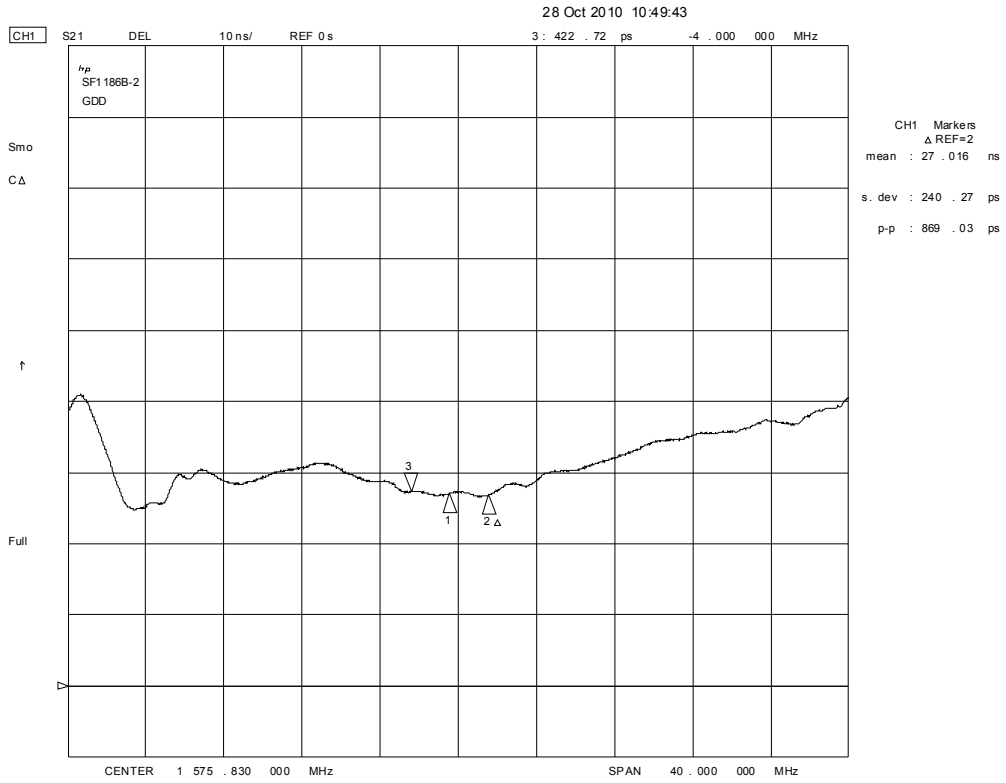

SM3030-6 Case

6-Terminal Ceramic Surface-Mount Case 3.0 X 3.0 mm Nominal Footprint

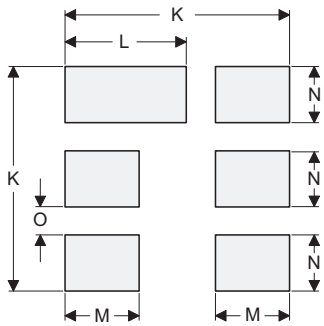
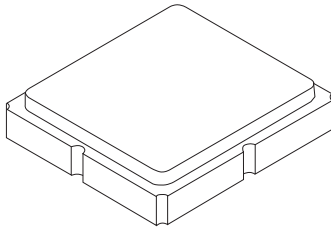

PCB Footprint Top View

Case and PCB Footprint Dimensions

Dimension	mm			Inches		
	Min	Nom	Max	Min	Nom	Max
A	2.87	3.00	3.13	0.113	0.118	0.123
B	2.87	3.00	3.13	0.113	0.118	0.123
C	1.12	1.25	1.38	0.044	0.049	0.054
D	0.77	0.90	1.03	0.030	0.035	0.040
E	2.67	2.80	2.93	0.105	0.110	0.115
F	1.47	1.60	1.73	0.058	0.063	0.068
G	0.72	0.85	0.98	0.028	0.033	0.038
H	1.37	1.50	1.63	0.054	0.059	0.064
I	0.47	0.60	0.73	0.019	0.024	0.029
J	1.17	1.30	1.43	0.046	0.051	0.056
K		3.20			0.126	
L		1.70			0.067	
M		1.05			0.041	
N		0.81			0.032	
O		0.38			0.015	

Case Materials

Materials	
Solder Pad Plating	0.3 to 1.0 μm Gold over 1.27 to 8.89 μm Nickel
Lid Plating	2.0 to 3.0 μm Nickel
Body	Al_2O_3 Ceramic
Pb Free	

TOP VIEW

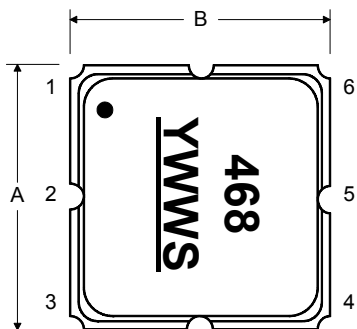

BOTTOM VIEW

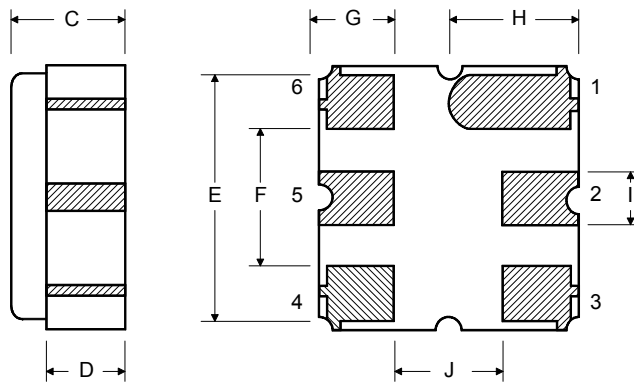

Tape and Reel Specifications

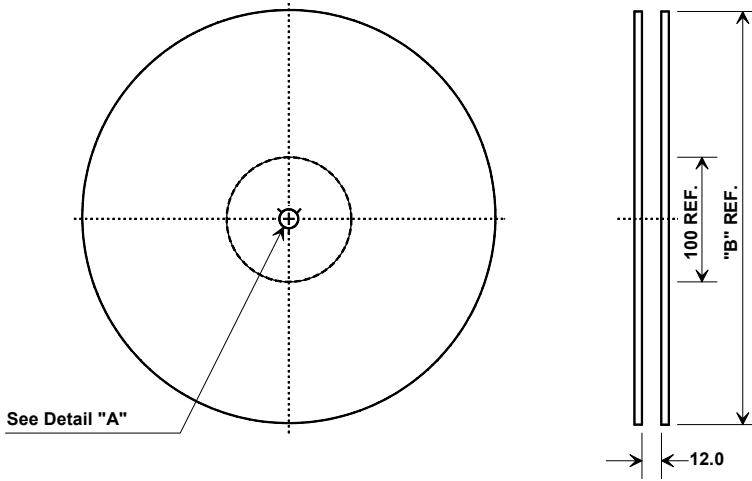

"B"		Quantity Per Reel
Inches	millimeters	
7	178	500
13	330	3000

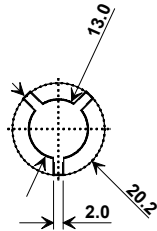

COMPONENT ORIENTATION

