

SAMZO REAC/ROHS

REV	ECN NO	DESCRIPTION	DESIGN	APPROVAL	DATE
A1	NEW	Replace frame			2018.06.12

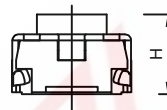
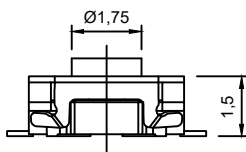
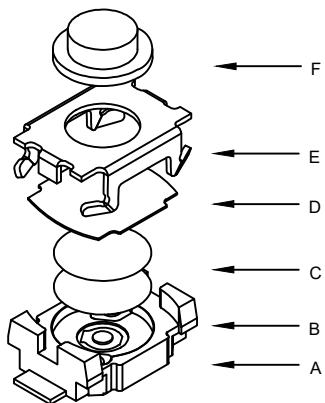

主要技术参数、性能  
The Main Thchnology Performance

额定电流、电压 Rate voltage, current	50mA DC12V
接触电阻 Contact resistance	≤100mΩ
按力 Operating force	±50gf
行程 Travel	0.20±0.10mm
绝缘电阻 Insulated resistance	≥100MΩ
介电强度 Dielectric strength	≥250VAC/1min

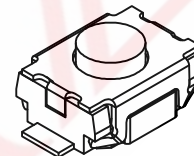
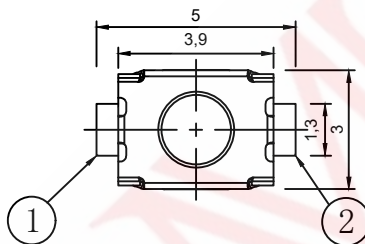

C    C    4    A    \*    \*    \*    \*    1    0  
 (A) (B) (C) (D) (E) (F) (G) (H)

- A. 系列:C-3\*4系列
- B. 贴装方式:4-立式贴片
- C. 引脚规格:A-2P
- D. 操作高度:18-1.8mm/20-2.0mm/25-2.5mm
- E. 操作力度:1-180gf/2-260gf
- F. 操作寿命:1-30,000次/2-100,000次/3-2,000,000次
- G. 固定方式:1-无柱
- H. 物料编码:0-常规(确认待编)

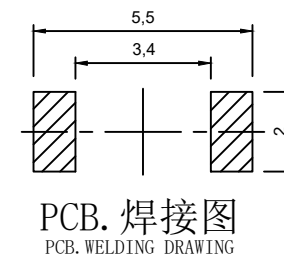
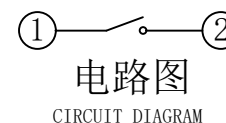

ITEM	DESCRIPTION	MATERIAL	QTY	FINISH/COLOR					
F	按钮	LCP	1	黑色					
E	盖板	不锈钢	1	清洗	GENERAL TOLERANCE				
D	防尘胶	聚酰亚胺	1	橙黄色	≥0~2<	±0.15	SCALE		
C	弹片	不锈钢	1	镀银	DESIGN	WANGGUIFA	2018.06.12	≥2~5<	±0.25
B	本件	LCP	1	黑色	CHECKED	ZHENGUILAN	2018.06.12	≥0~2<	±0.15
A	卡件	磷铜	1	镀银	APPROVED	LILIANJIANG	2018.06.14	≥5	±0.35

FIRST VIEW

SCALE 1:1 UNIT mm

**SAMZO COMPONENTS**  
Electronic switch and connector manufacturer

The copyright belongs to samzo parts [China] Co., Ltd. please use the material after samzo parts agree to authorize. The final right of interpretation belongs to samzo parts. WWW.KKK-JP.COM

TITLE::	3*4*H mm 2P-LT
DWG NO:	C4A-P300
PART NO:	C4A182501
MODEL NO:	C4A**-**-10
NAME:	TACT SWITCH