

1-104479-0 ✓ ACTIVE

AMPMODU | AMPMODU IV/V

TE Internal #: 1-104479-0

Socket Contact, Gold, 300 VAC, Discrete Wire, 24 – 20 AWG Wire Size, .2 – .6 mm<sup>2</sup> Wire Size, 394.71 – 1184.12 CMA Wire Size, Crimp, AMPMODU IV/V

[View on TE.com >](#)



Connectors > Contacts > Connector Contacts

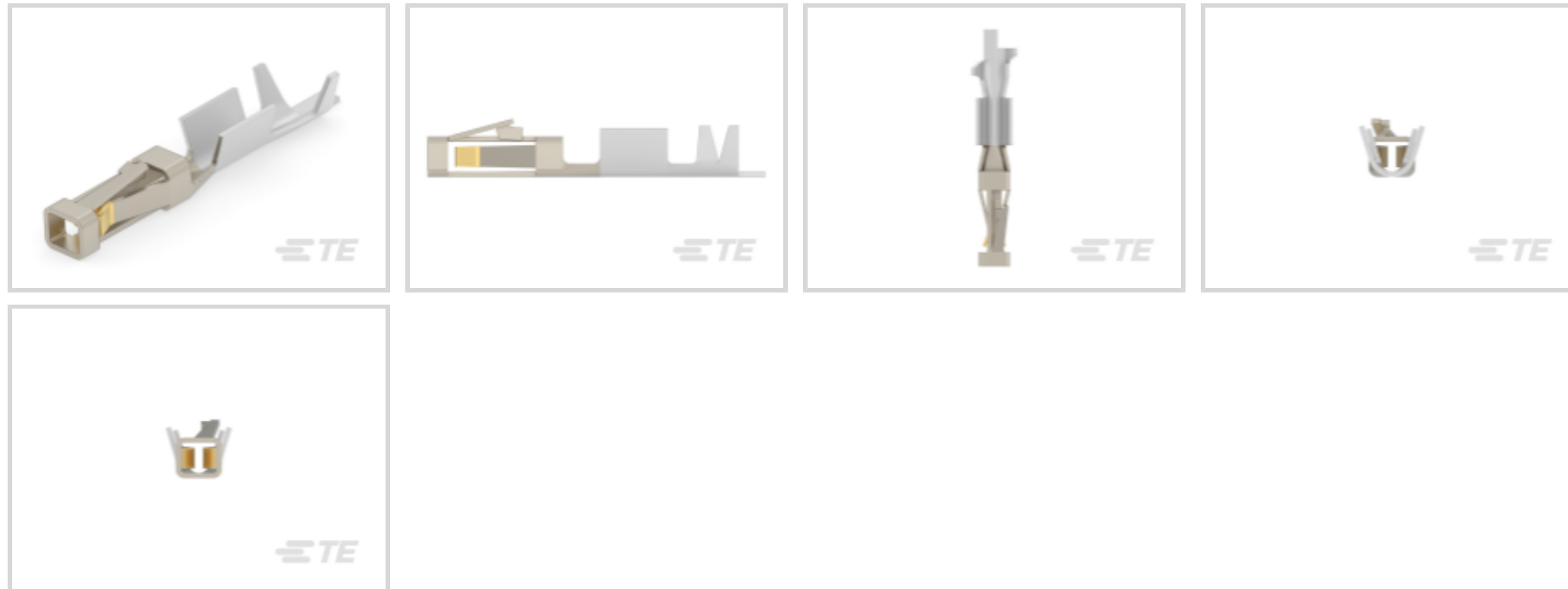

Contact Type: **Socket**

Contact Mating Area Plating Material: **Gold**

Wire Contact Termination Area Plating Material: **Tin**

Operating Voltage: **300 VAC**

Compatible With Wire & Cable Type: **Discrete Wire**

## Features

### Product Type Features

Applied Pressure	Standard
------------------	----------

### Configuration Features

Compatible With Wire & Cable Type	Discrete Wire
-----------------------------------	---------------

### Electrical Characteristics

Termination Resistance	12 mΩ
Insulation Resistance	5000 MΩ
Dielectric Withstanding Voltage (Max)	750 V
Operating Voltage	300 VAC

### Contact Features

Mating Square Post Dimension	.64 mm[.025 in]
	50 – 100 μin
Contact Type	Socket
Contact Mating Area Plating Material	Gold
Wire Contact Termination Area Plating Material	Tin



Contact Base Material	Copper Alloy
-----------------------	--------------

Contact Current Rating (Max)	3 A
------------------------------	-----

### Termination Features

Termination Method to Wire & Cable	Crimp
------------------------------------	-------

Product Terminates To	Wire & Cable
-----------------------	--------------

### Mechanical Attachment

Wire Insulation Support	With
-------------------------	------

### Dimensions

Compatible Insulation Diameter Range	.64 – 1.52 mm [.025 – .06 in]
--------------------------------------	-------------------------------

Wire Size	394.71 – 1184.12 CMA
-----------	----------------------

### Usage Conditions

Operating Temperature Range	-65 – 105 °C [-85 – 221 °F]
-----------------------------	-----------------------------

### Operation/Application

Circuit Application	Power & Signal
---------------------	----------------

### Industry Standards

Compatible With Approved Standards Products	CSA LR7189, UL E28476
---	-----------------------

### Packaging Features

Packaging Quantity	15000
--------------------	-------

Packaging Method	Reel
------------------	------

### Product Compliance

[For compliance documentation, visit the product page on TE.com>](#)

EU RoHS Directive 2011/65/EU	Compliant
------------------------------	-----------

EU ELV Directive 2000/53/EC	Compliant
-----------------------------	-----------

China RoHS 2 Directive MIIT Order No 32, 2016	No Restricted Materials Above Threshold
---	---

EU REACH Regulation (EC) No. 1907/2006	Current ECHA Candidate List: JUNE 2024 (241) Candidate List Declared Against: JUNE 2024 (241) Does not contain REACH SVHC
--	---

Halogen Content	Low Halogen - Br, Cl, F, I < 900 ppm per homogenous material. Also BFR/CFR/PVC Free
-----------------	---

Solder Process Capability	Not applicable for solder process capability
---------------------------	--

Product Compliance Disclaimer

This information is provided based on reasonable inquiry of our suppliers and represents our current actual knowledge based on the information they provided. This information is subject to change. The part numbers that TE has identified as EU RoHS compliant have a maximum concentration of 0.1% by weight in homogenous materials for lead, hexavalent chromium, mercury, PBB, PBDE, DBP, BBP, DEHP, DIBP, and 0.01% for cadmium, or qualify for an exemption to these limits as defined in the Annexes of Directive 2011/65/EU (RoHS2). Finished electrical and electronic equipment products will be CE marked as required by Directive 2011/65/EU. Components may not be CE marked. Additionally, the part numbers that TE has identified as EU ELV compliant have a maximum concentration of 0.1% by weight in homogenous materials for lead, hexavalent chromium, and mercury, and 0.01% for cadmium, or qualify for an exemption to these limits as defined in the Annexes of Directive 2000/53/EC (ELV). Regarding the REACH Regulation, the information TE provides on SVHC in articles for this part number is based on the latest European Chemicals Agency (ECHA) 'Guidance on requirements for substances in articles' posted at this URL: <https://echa.europa.eu/guidance-documents/guidance-on-reach>

## Compatible Parts

 <p>TE Part # 843477-1 TOOL, EXTRACTION RESET</p>	 <p>TE Part # 1-104482-8 40 SHORT PT RCPT HSG DR .100CL</p>	 <p>TE Part # 104483-4 26 SHORT PT RCPT HSG DR .100CL</p>	 <p>TE Part # 104483-5 30 SHORT PT RCPT HSG DR .100CL</p>
 <p>TE Part # 104257-9 10 MTE RCPT HSG SR LATCH .100</p>	 <p>TE Part # 1-104257-3 14 MTE RCPT HSG SR LATCH .100</p>	 <p>TE Part # 104257-6 07 MTE RCPT HSG SR LATCH .100</p>	 <p>TE Part # 104257-7 08 MTE RCPT HSG SR LATCH .100</p>
 <p>TE Part # 1-104257-5 16 MTE RCPT HSG SR LATCH .100</p>	 <p>TE Part # 104257-2 03 MTE RCPT HSG SR LATCH .100</p>	 <p>TE Part # 104257-5 06 MTE RCPT HSG SR LATCH .100</p>	 <p>TE Part # 103648-7 08 MTE RCPT HSG SR RIB .100CL</p>



Also in the Series | AMPMODU IV/V

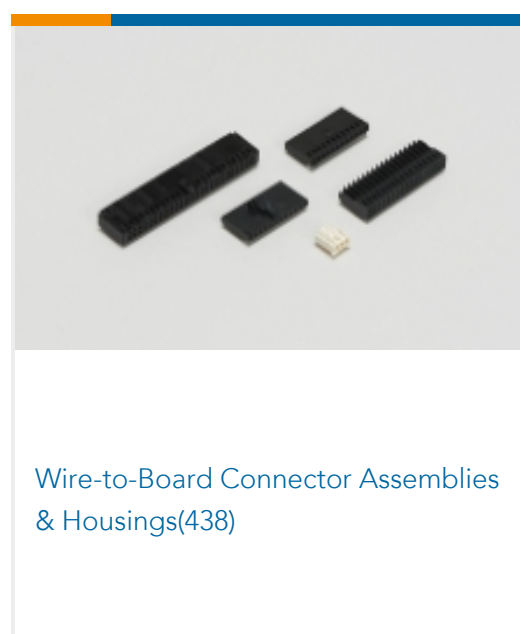
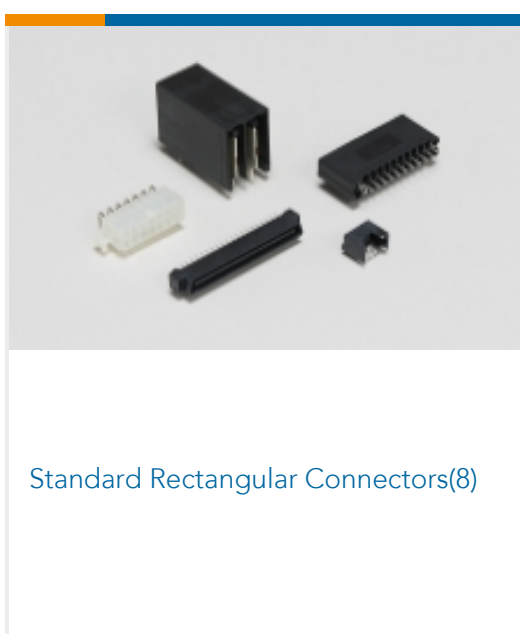
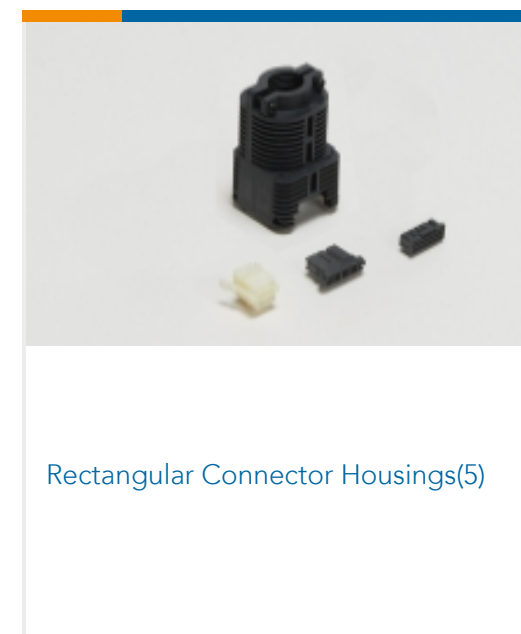
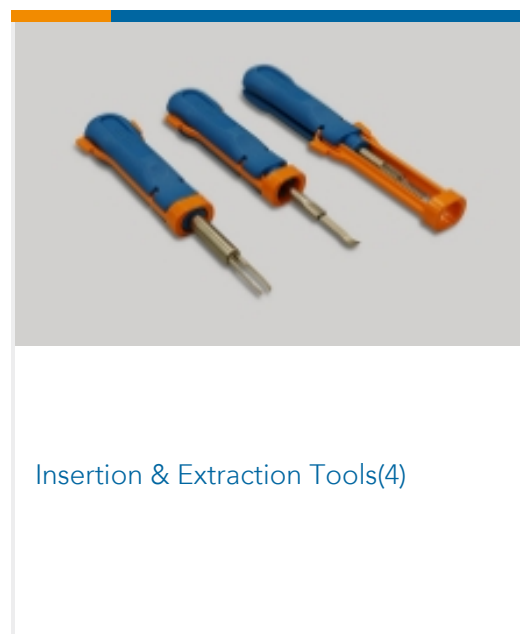
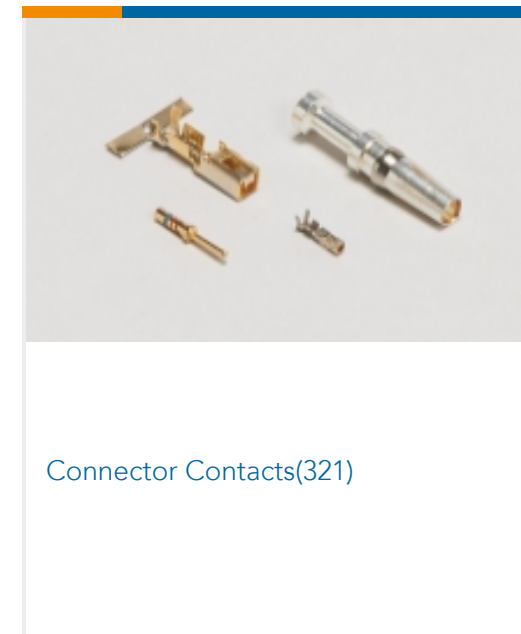
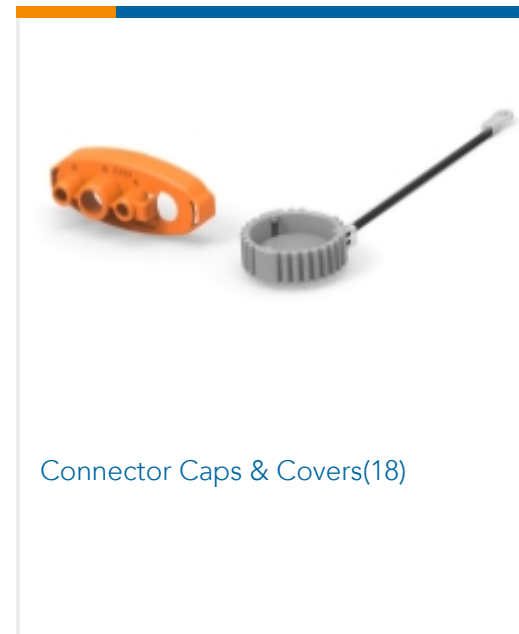
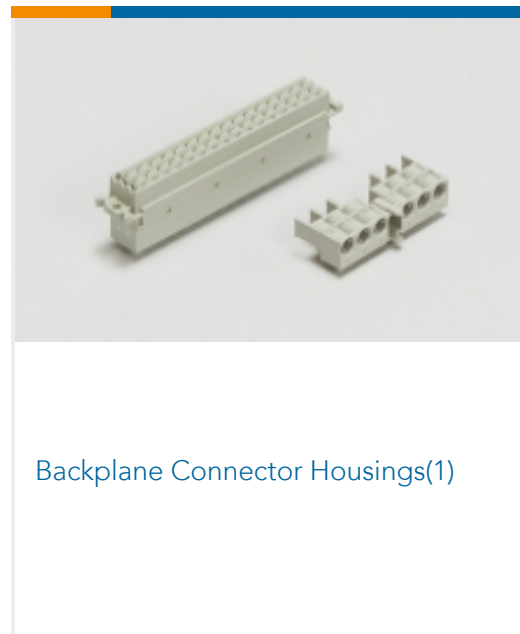
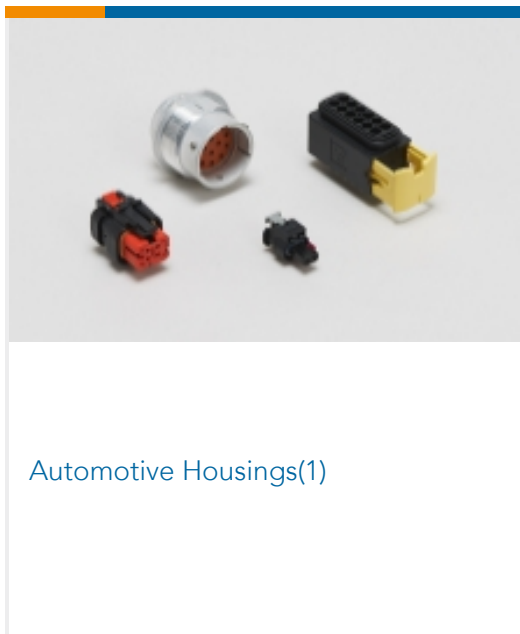

Customers Also Bought





TE Part #5-917688-1  
SIGNAL DOUBLE LOCK PLUG HSG 4P  
GWT



TE Part #6609008-7  
1EJHP=F8038



TE Part #2-33458-3  
TERMINAL,SOLIS R 12-10 1/4

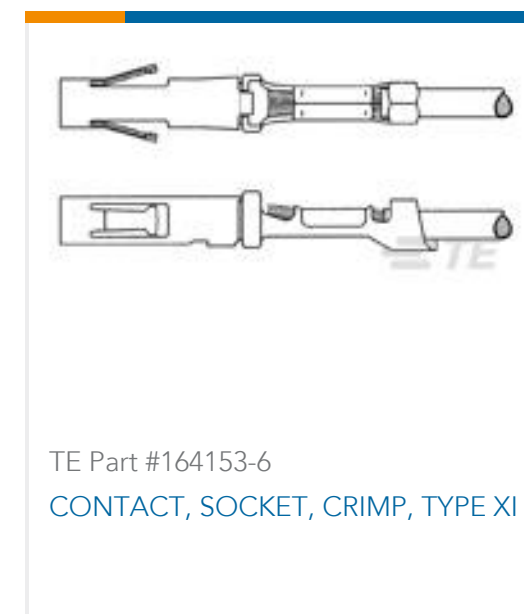

TE Part #164153-6  
CONTACT, SOCKET, CRIMP, TYPE XI



TE Part #3-2176510-0  
CJP 500W 390R 5% Lead



TE Part #2-964286-1  
JPT A REC 2.8 Contact SWS Au



TE Part #2195846-8  
FPC ANT, MHF4L, 200mm, 698-7125  
MHz

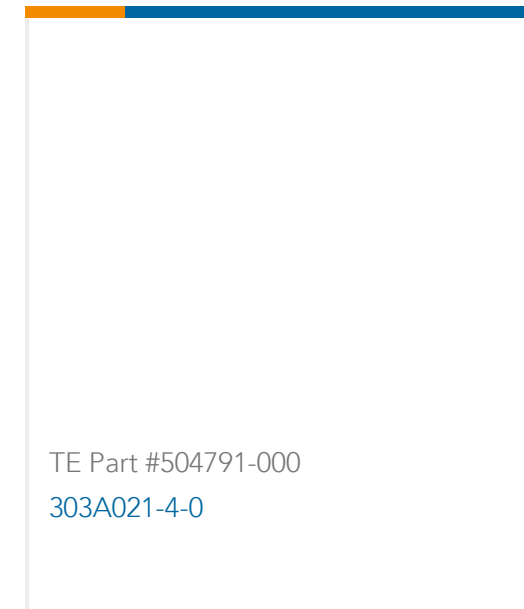

TE Part #504791-000  
303A021-4-0



TE Part #1106411-2  
HA.10.STS.1.M20.G

## Documents

### Product Drawings

[SHORT POINT CONT 30 DPLX STMPD LF](#)

English

### CAD Files

[3D PDF](#)

English

[Customer View Model](#)

[ENG\\_CVM\\_1-104479-0\\_R.2d\\_dxf.zip](#)

English

[Customer View Model](#)

[ENG\\_CVM\\_1-104479-0\\_R.3d\\_igs.zip](#)

English

[Customer View Model](#)

[ENG\\_CVM\\_1-104479-0\\_R.3d\\_stp.zip](#)

English

[3D PDF](#)

3D



### Customer View Model

[ENG\\_CVM\\_CVM\\_1-104479-0\\_AF.2d\\_dxf.zip](#)

English

### Customer View Model

[ENG\\_CVM\\_CVM\\_1-104479-0\\_AF.3d\\_igs.zip](#)

English

### Customer View Model

[ENG\\_CVM\\_CVM\\_1-104479-0\\_AF.3d\\_stp.zip](#)

English

By downloading the CAD file I accept and agree to the [Terms and Conditions](#) of use.

### Datasheets & Catalog Pages

[AMPMODU\\_INTERCONNECTION\\_SYSTEM\\_SECTION5\\_CONT](#)

English

[AMPMODU MTE INTERCONNECT SYSTEM](#)

English

### Product Specifications

[Application Specification](#)

English