

DC-DC converter with wide input voltage,
non-isolated & regulated single output

FEATURES

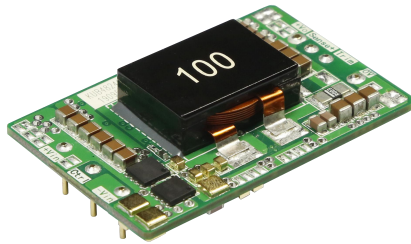

CE Patent Protection RoHS



- High efficiency up to 97%
- Input under-voltage protection, output short-circuit, over-current protection
- Operating ambient temperature range: -40°C to +85°C
- Open frame package
- 1/4-Brick package industry standard pin-out
- Adjustable input starting (under-voltage) voltage
- EN62368 approved

KUB48_QB-10A series are non-isolated DC-DC products with 10A output current and wide input voltage. They feature efficiency up to 97%, operating ambient temperature of -40°C to +85°C, input under-voltage, output short-circuit, over-current protection. The products meet CLASS A of CISPR32/EN55032 emissions standards by adding the recommended external components and they are widely used in applications such as battery powered systems and robotic field.

Selection Guide

Certification	Part No.	Input Voltage (VDC)		Output		Full Load Efficiency (%) Min./Typ.	Capacitive Load (µF) Max.
		Nominal (Range)	Max.*	Voltage (VDC)	Current (A) Max.		
CE	KUB4824QB-10A	48 (30-75)	80	24	10	94/97	3300
	KUB4812QB-10A	48 (16-75)		12	10	92/95	5500

Note: * Exceeding the maximum input voltage may cause permanent damage.

Input Specifications

Item	Operating Conditions	Min.	Typ.	Max.	Unit
Input Current (full load / no-load)	Nominal input voltage, KUB4824QB-10A	--	5208/35	5320/80	mA
	Nominal input voltage, KUB4812QB-10A	--	2660/35	2718/80	
Reflected Ripple Current	Nominal input voltage	--	200	--	VDC
Surge Voltage (1sec. max.)		-0.7	--	80	
Starting Voltage	KUB4824QB-10A	--	--	30	
	KUB4812QB-10A	--	--	16	
Under-voltage protection	KUB4824QB-10A	25	27	--	
	KUB4812QB-10A	12.5	14	--	
Adjustable input Starting(Under-voltage) Voltage	Refer to Design Reference for details	KUB4824QB-10A 30	--	75	
		KUB4812QB-10A 16	--	75	
Input Filter		Capacitance filter			
Ctrl*	Module on	Ctrl pin open or pulled high (1.5-12VDC)			
	Module off	Ctrl pin pulled low to GND (0-0.8VDC)			
	Input current when off	--	2	10	mA
Hot Plug		Unavailable			

Note: * The voltage of Ctrl pin is relative to input pin GND.

Output Specifications

Item	Operating Conditions	Min.	Typ.	Max.	Unit
Voltage Accuracy	0%-100% load	--	±1	±3	%
Linear Regulation	Full load, the input voltage is from low to high	--	±0.1	±0.5	

Load Regulation	5%-100% load	--	±0.3	±2	%
Transient Recovery Time	25% load step change	--	200	500	µs
Transient Response Deviation	25% load step change	--	±4	±5	%
Temperature Coefficient	Full load	--	--	±0.03	%/°C
Ripple & Noise*	20MHz bandwidth	--	150	220	mVp-p
Over-current protection	Input voltage range	110	130	190	%Io
Short-circuit Protection		Hiccup, continuous, self-recovery			

Note: * The "parallel cable" method is used for Ripple and Noise test, please refer to DC-DC Converter Application Notes for specific information;

General Specifications

Item	Operating Conditions	Min.	Typ.	Max.	Unit	
Trim		90	--	110	%Vo	
Sense	Refer to Remote Sense Application for details	--	--	105		
Operating Temperature		-40	--	+85	°C	
Storage Temperature		-55	--	+125		
Pin Soldering Resistance Temperature	Wave-soldering, 10s	--	--	260		
Storage Humidity	Non-condensing	5	--	95	%RH	
Vibration		10-150Hz, 5g, 0.75mm, 90 Min. along X, Y and Z				
Switching Frequency	PWM mode	KUB4824QB-10A	--	250	--	KHz
		KUB4812QB-10A	--	200	--	
MTBF	MIL-HDBK-217F@25°C	1000	--	--	K hours	

Mechanical Specifications

Dimensions	59.20 x 37.60 x 13.00 mm
Weight	33.0g(Typ.)
Cooling Method	Nature convection or forced convection

Electromagnetic Compatibility (EMC)

Emissions	CE	CISPR32/EN55032 CLASS A (see Fig. 2 for recommended circuit)	
	RE	CISPR32/EN55032 CLASS A (see Fig. 2 for recommended circuit)	
Immunity	ESD	IEC/EN61000-4-2	Contact ±6KV perf. Criteria B
	RS	IEC/EN61000-4-3	10V/m perf. Criteria A
	EFT	IEC/EN61000-4-4	±2KV (see Fig. 2 for recommended circuit) perf. Criteria A
	Surge	IEC/EN61000-4-5	±2KV (see Fig. 2 for recommended circuit) perf. Criteria B
	CS	IEC/EN61000-4-6	10 Vr.m.s perf. Criteria A

Typical Characteristic Curves

Efficiency Vs Input Voltage (Full Load)

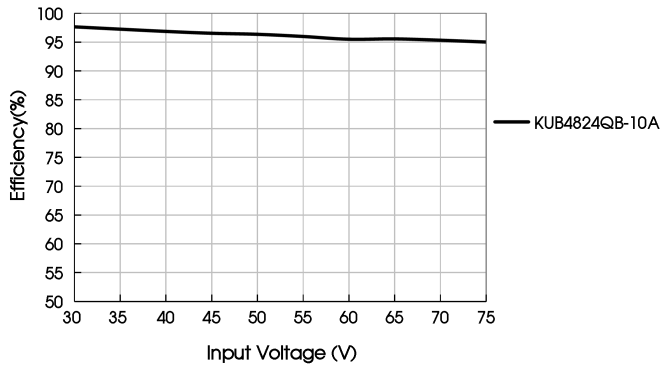

Efficiency Vs Output Load (Vin=48V)

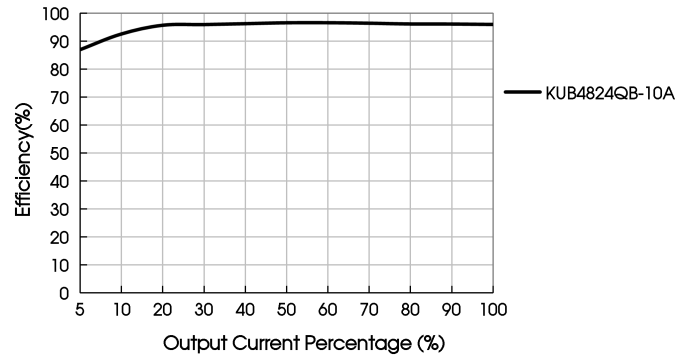

KUB4824QB-10A Temperature Derating Curves (30V ≤ Vin ≤ 48V)

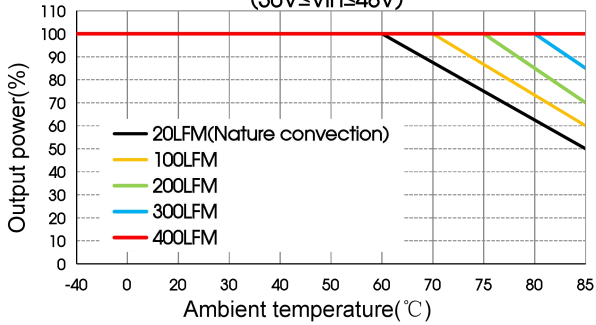

KUB4824QB-10A Temperature Derating Curves (48V < Vin ≤ 55V)

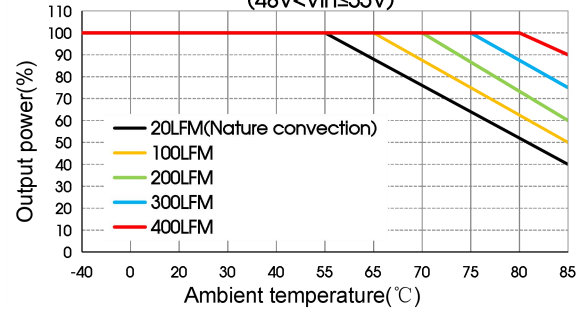

KUB4824QB-10A Temperature Derating Curves (55V < Vin ≤ 75V)

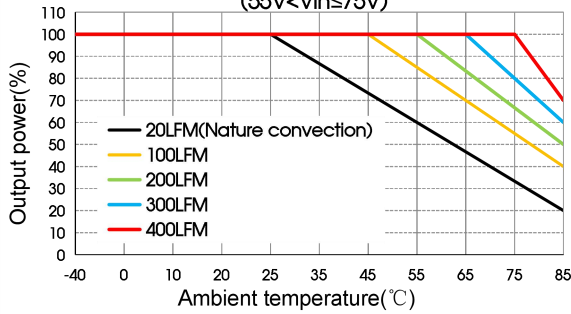

KUB4812QB-10A Temperature Derating Curves (16V ≤ Vin ≤ 48V)

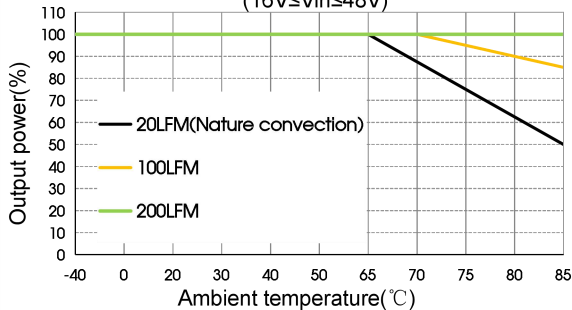

KUB4812QB-10A Temperature Derating Curves (48V < Vin ≤ 55V)

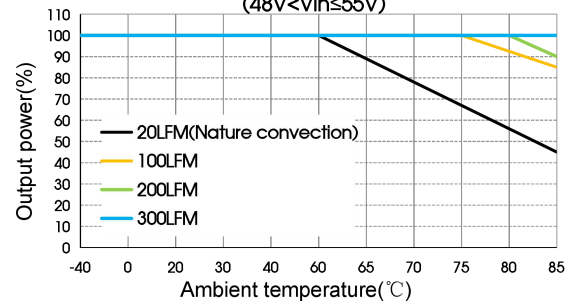

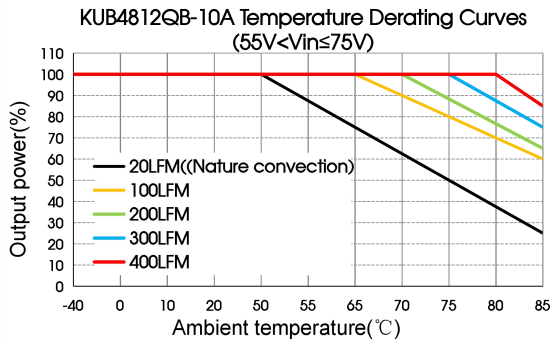

Notes:

1) Product application thermal design should be referred to the recommended PCB layout and recommended heat dissipation structure, please see DC-DC Converter Application Notes for specific operation.

Remote Sense Application

1. Remote sense connection if not used

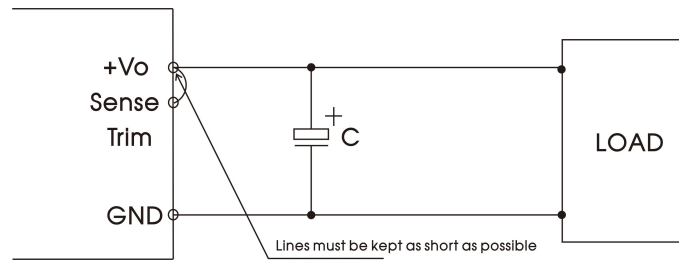

Notes:

- 1). If the sense function is not used for remote regulation the user must connect the Sense to +Vo at the DC-DC converter pins and will compensate for voltage drop across pins only;
- 2). The connections between Sense and +Vo must be kept as short as possible, otherwise they may be picking up noise, interference and/or causing unstable operation of the power module.

2. Remote sense connection used for compensation

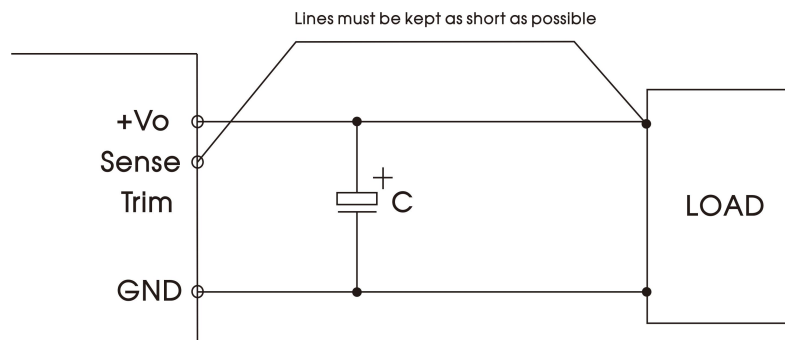

Notes:

- 1) Using remote sense with long wires may cause unstable output, please contact technical support if long wires must be used.
- 2) We recommend using adequate cross section for PCB-track layout and/or cables to connect the power supply module to the load in order to keep the voltage drop below 0.3V and to make sure the power supply's output voltage remains within the specified range.
- 3) Note that large wire impedance may cause oscillation of the output voltage and/or increased ripple. Consult technical support or factory for further advice of sense operation.

Design Reference

1. Typical application

- (1) We recommended using the recommended circuit shown in Fig.1 during product testing and application, otherwise please ensure that at least a 100µF electrolytic capacitors is connected at the input in order to ensure adequate voltage surge suppression and protection.
- (2) We recommended increasing the value of Cin and pay attention to the unstable input voltage if the product input side is paralleled with motor drive circuit and/or larger energy transient circuits, to ensure the stability of input terminal and avoid repeatedly start-up problems due to input voltage lower than undervoltage protection point.
- (3) We recommended increasing the output capacitance with limited to the capacitive load specification and/or increasing the voltage clamping circuit(such as TVS) if the output terminal is inductive device such as relay or a motor, to ensure adequate voltage surge suppression and protection.
- (4) Input and/or output ripple can be further reduced by appropriately increasing the input & output capacitor values Cin and Cout and/or by selecting capacitors with a low ESR (equivalent series resistance). Also make sure that the capacitance is not exceeding the specified max. capacitive load value of the product.

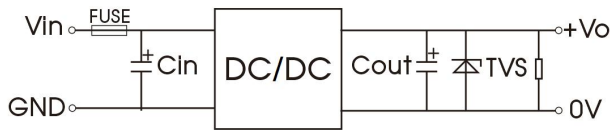

Fig. 1

Vout(VDC)	Fuse	Cin ^①	Cout	TVS
12	20A, slow	100µF	100µF	SMDJ14A
24	blow			SMDJ28A

Note:

①Please pay attention to the ambient temperature of the product when using an external capacitor, increase the electrolytic capacitor values to at least 1.5 times the original parameter if the ambient temperature is low.

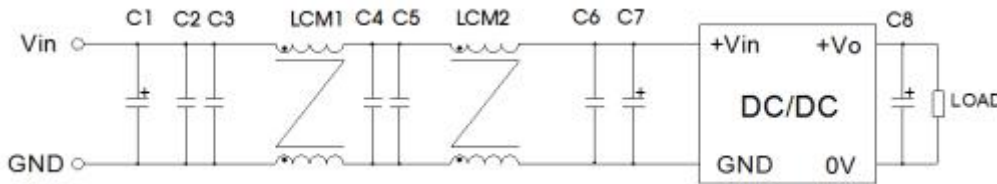
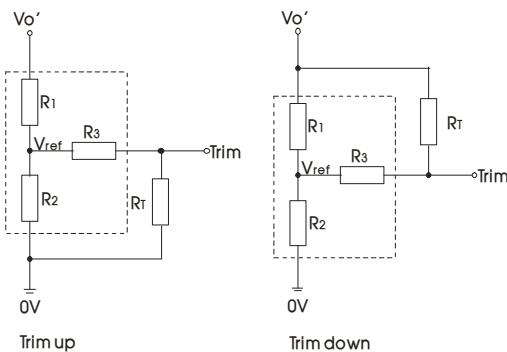

Fig. 2

Components	Recommended Component value	Components function
C1	1000 µ F electrolytic capacitor	Meet EFT and Surge
C7	330 µ F electrolytic capacitor	
C1	1000 µ F electrolytic capacitor	Meet CE and RE
C7	330 µ F electrolytic capacitor	
C8	100 µ F electrolytic capacitor	
C2, C3, C4, C5, C6	4.7 µ F electrolytic capacitor	
LCM1, LCM2	47 µ H common mode inductor (TN120L T-12.7-7.9-CPY)	

2. Trim Function for Output Voltage Adjustment (open if unused)



TRIM resistor connection (dashed line shows internal resistor network)

Calculation formula of Trim resistance:

$$\text{up: } R_T = \frac{\alpha R_2}{R_2 - \alpha} - R_3 \quad \alpha = \frac{V_{ref}}{V_{o'} - V_{ref}} \cdot R_1$$

$$\text{down: } R_T = \frac{\alpha R_1}{R_1 - \alpha} - R_3 \quad \alpha = \frac{V_{o'} - V_{ref}}{V_{ref}} \cdot R_2$$

R_T = Trim Resistor value;

α = self-defined parameter

$V_{o'}$ = desired output voltage ($\pm 10\%$ max.)

Vout(VDC)	R1(KΩ)	R2(KΩ)	R3(KΩ)	Vref(V)
12	330	23.48	120	0.8
24	330	11.38	91	0.8

Note: When using the Trim down function make sure that the RT resistor value is calculated correctly. If the Trim pin is shorted with +Vo, or its value is too low, then the output voltage Vo would be lower, which may cause the product to fail.

3. Adjustable input Starting (Under-voltage) Voltage and Resistor calculation

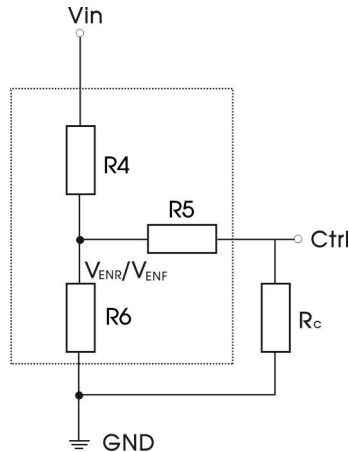

Adjustable input Starting (Under-voltage) Voltage resistor connection (dashed line shows internal resistor network)

Calculation resistor of Adjustable input Starting (Under-voltage) Voltage:

$$R_C = \frac{bR_5}{R_5 - b} - R_6 \quad b = \frac{V_{EN}}{V_{in} - V_{EN}} \cdot R_4$$

R_C : resistor of Adjustable input Starting (Under-voltage) Voltage:

b : self-defined parameter

When $V_{EN} = V_{ENR}$, V_{in} is actual starting voltage required for input;

When $V_{EN} = V_{ENF}$, V_{in} is actual under-voltage required for input;

Vout(VDC)	R4(KΩ)	R5(KΩ)	R6(KΩ)	$V_{ENR}(V)$	$V_{ENF}(V)$
12	100	8.93	0.1	1.22	1.09
24	100	4.32	0.1	1.22	1.09

4. The products do not support parallel connection of their output.

5. For additional information please refer to DC-DC converter application notes on www.mornsun-power.com

Dimensions and Recommended Layout(KUB48XXQB-10A)

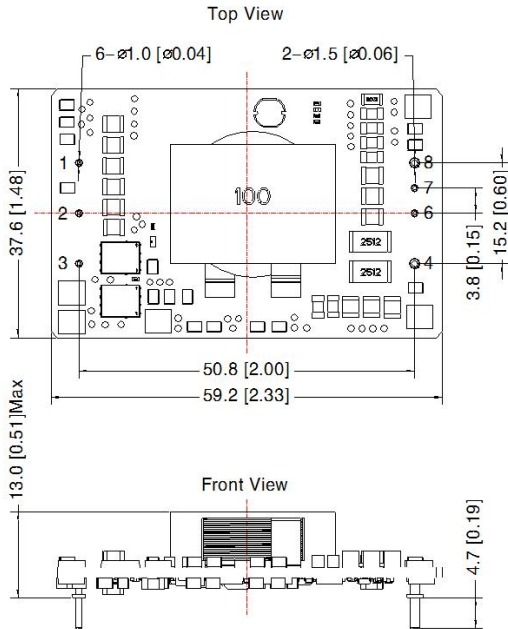

THIRD ANGLE PROJECTION

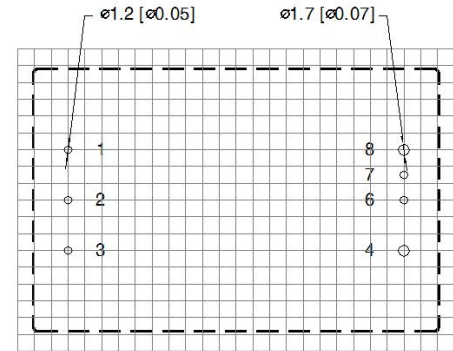

Note: Grid 2.54*2.54mm

Pin-Out			
Pin	Function	Pin	Function
1	+Vin	4	0V
2	Ctrl	6	Trim
3	-Vin	7	Sense+
		8	+Vo

Note:
Unit: mm[inch]
Pin1,2,3,6,7's diameter: 1.0[0.04]
Pin4,8's diameter: 1.5[0.06]
Pin diameter tolerances: $\pm 0.1[\pm 0.004]$
General tolerances: $\pm 0.5[\pm 0.02]$
Device layout is for reference only, the specific object shall prevail

Notes:

- For additional information on Product Packaging please refer to www.mornsun-power.com. Packaging bag number: 58010113;
- The maximum capacitive load offered were tested at input voltage range and full load;
- Unless otherwise specified, parameters in this datasheet were measured under the conditions of $T_a=25^\circ\text{C}$, humidity<75%RH with nominal input voltage and rated output load;
- All index testing methods in this datasheet are based on company corporate standards;
- We can provide product customization service, please contact our technicians directly for specific information;
- Products are related to laws and regulations: see "Features" and "EMC";
- Our products shall be classified according to ISO14001 and related environmental laws and regulations, and shall be handled by qualified units.

MORNSUN Guangzhou Science & Technology Co., Ltd.

Address: No. 5, Kehui St. 1, Kehui Development Center, Science Ave., Guangzhou Science City, Huangpu District, Guangzhou, P. R. China
Tel: 86-20-38601850 Fax: 86-20-38601272 E-mail: info@mornsun.cn www.mornsun-power.com