

51864-1 ✓ ACTIVE



PIDG

TE Internal #: 51864-1

Closed Ring Tongue Terminal, 16 – 14 AWG, #8 / M4 Stud Size, 4.34 mm [.171 in] Stud Diameter, Closed Barrel, Straight, Tin, Partially Insulated, PIDG

[View on TE.com >](#)

Terminals & Splices > Ring Terminals > PIDG Ring Tongue Terminals

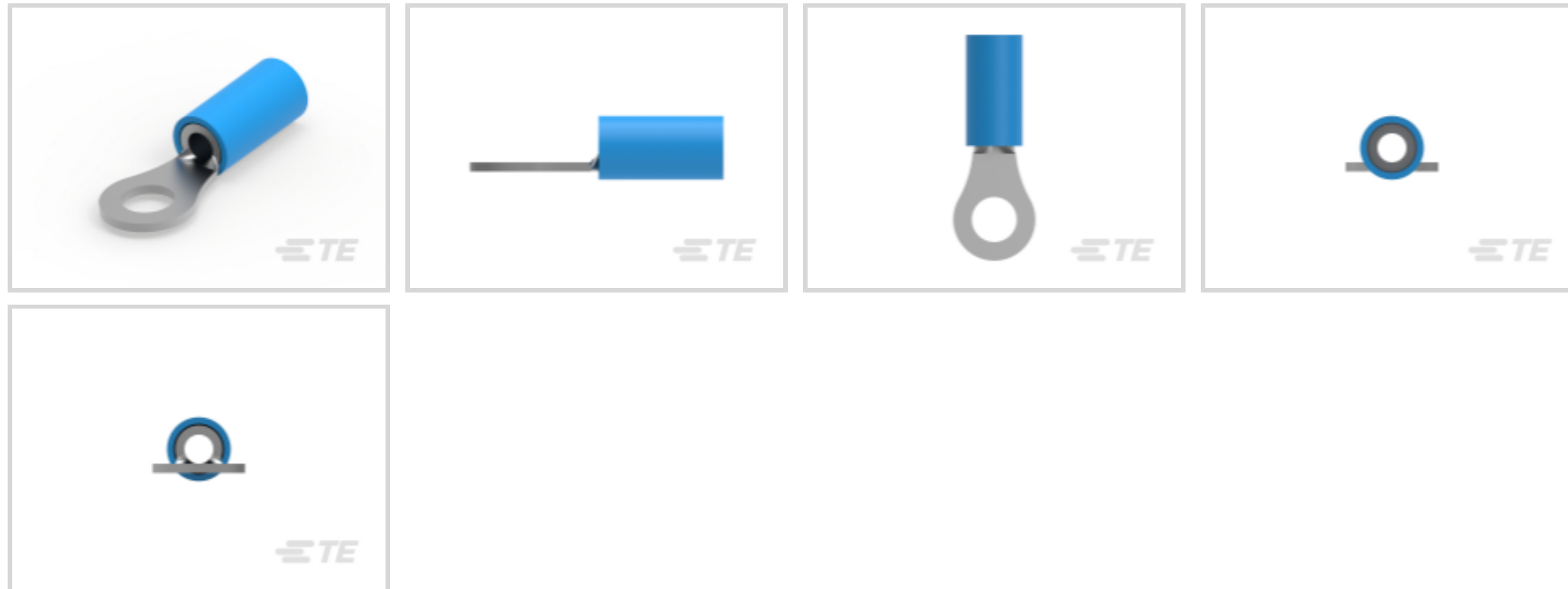

Ring Terminal Product Type: Closed Ring Tongue Terminal

Wire Size: 2050 – 5180 CMA

Stud Size: #8, M4

[All PIDG Ring Tongue Terminals \(411\)](#)

Features

Product Type Features

Ring Terminal Product Type	Closed Ring Tongue Terminal
Stud Size	#8, M4
Sealable	No
Wire Insulation Support Retention Type	Insulation Support

Configuration Features

Number of Holes	1
-----------------	---

Electrical Characteristics

Voltage Rating	300 V
----------------	-------

Body Features

Insulation Sleeve Color	Blue
Stripe Color	Blue
Product Weight	.986 g

Contact Features

--	--



Military Part Class	Class I
Barrel Type	Closed
Terminal Orientation	Straight
Terminal Plating Material	Tin

Mechanical Attachment

Wire Insulation Support	With
-------------------------	------

Dimensions

Wire Size	2050 – 5180 CMA
Stud Diameter	4.34 mm [.171 in]
Tongue Thickness	.79 mm [.031 in]
Product Length	21.44 mm [.844 in]
Compatible Insulation Diameter (Max)	3.81 mm [.15 in]
Compatible Insulation Diameter Range	2.67 – 3.81 mm [.105 – .15 in]

Usage Conditions

Insulation Option	Partially Insulated
Operating Temperature Range	105 °C [221 °F]

Operation/Application

Compatible With Wire Base Material	Copper
Compatible With Wire Plating Material	Tin

Industry Standards

Government Qualified Terminal	Yes
-------------------------------	-----

Packaging Features

Packaging Quantity	1000
Packaging Method	Loose Piece

Product Compliance

[For compliance documentation, visit the product page on TE.com>](#)

EU RoHS Directive 2011/65/EU	Compliant
EU ELV Directive 2000/53/EC	Compliant
China RoHS 2 Directive MIIT Order No 32, 2016	No Restricted Materials Above Threshold
EU REACH Regulation (EC) No. 1907/2006	Current ECHA Candidate List: JUNE 2024 (241)



Candidate List Declared Against: JUNE
 2024 (241)
 Does not contain REACH SVHC

Halogen Content	Low Halogen - Br, Cl, F, I < 900 ppm per homogenous material. Also BFR/CFR/PVC Free
Solder Process Capability	Not applicable for solder process capability

Product Compliance Disclaimer

This information is provided based on reasonable inquiry of our suppliers and represents our current actual knowledge based on the information they provided. This information is subject to change. The part numbers that TE has identified as EU RoHS compliant have a maximum concentration of 0.1% by weight in homogenous materials for lead, hexavalent chromium, mercury, PBB, PBDE, DBP, BBP, DEHP, DIBP, and 0.01% for cadmium, or qualify for an exemption to these limits as defined in the Annexes of Directive 2011/65/EU (RoHS2). Finished electrical and electronic equipment products will be CE marked as required by Directive 2011/65/EU. Components may not be CE marked. Additionally, the part numbers that TE has identified as EU ELV compliant have a maximum concentration of 0.1% by weight in homogenous materials for lead, hexavalent chromium, and mercury, and 0.01% for cadmium, or qualify for an exemption to these limits as defined in the Annexes of Directive 2000/53/EC (ELV). Regarding the REACH Regulation, the information TE provides on SVHC in articles for this part number is based on the latest European Chemicals Agency (ECHA) 'Guidance on requirements for substances in articles' posted at this URL: <https://echa.europa.eu/guidance-documents/guidance-on-reach>

Compatible Parts

<p>TE Part # 58433-3 PRO CR ASSY, RBY IS9252</p>	<p>TE Part # 59250 T-HEAD PIDG 26-14 ASSY</p>	<p>TE Part # 58423-1 DIE, RBY IS9252</p>	<p>TE Part # 47387-7 DAHT PG PIDG 16-12 ASSY</p>
<p>TE Part # 59824-1 TETRA-CRIMP PIDG PG FASTON 22-10 ASSY</p>	<p>TE Part # 47387 DAHT PG PIDG 20-14 ASSY</p>	<p>TE Part # 525691 DAHT PG PIDG 16-14 ASSY</p>	<p>TE Part # 539691-2 ERGO DIE R.B.Y</p>

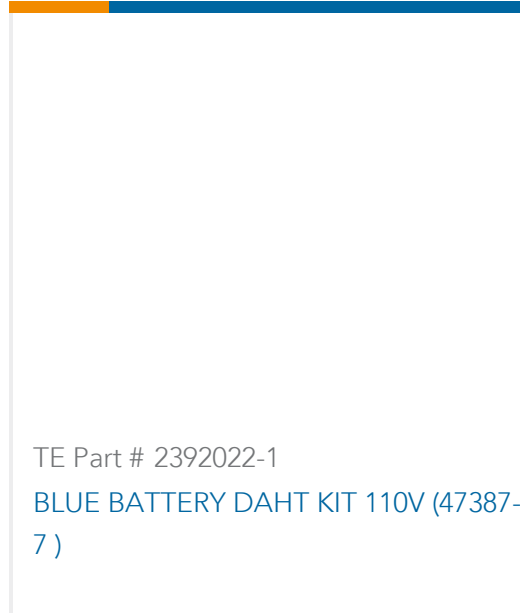
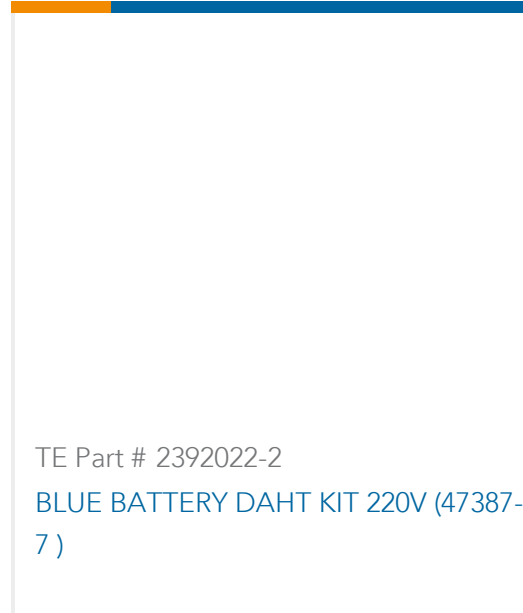

Also in the Series | PIDG

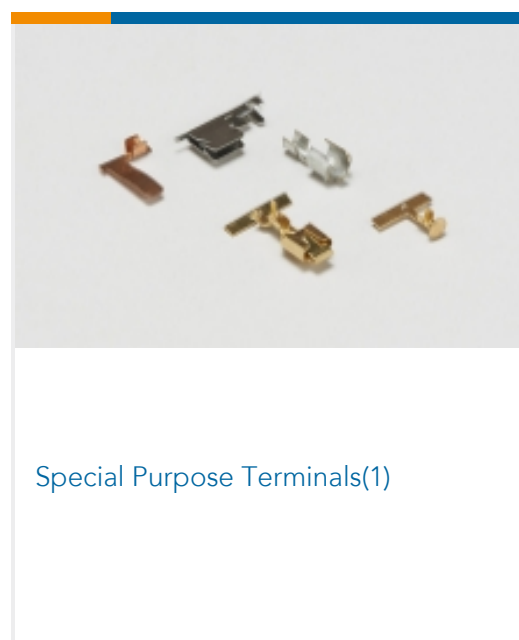
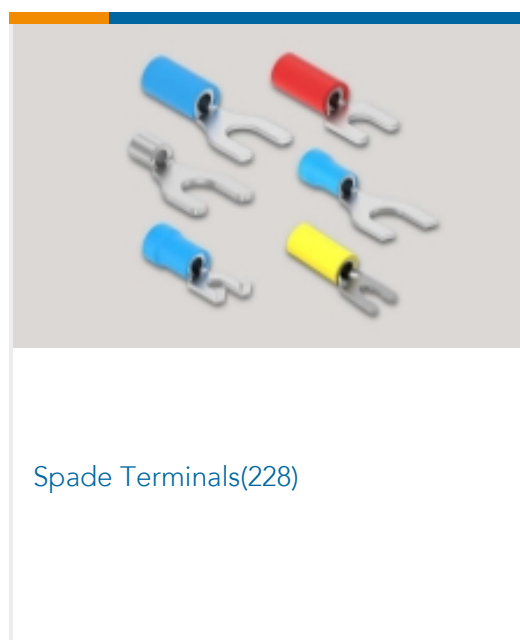
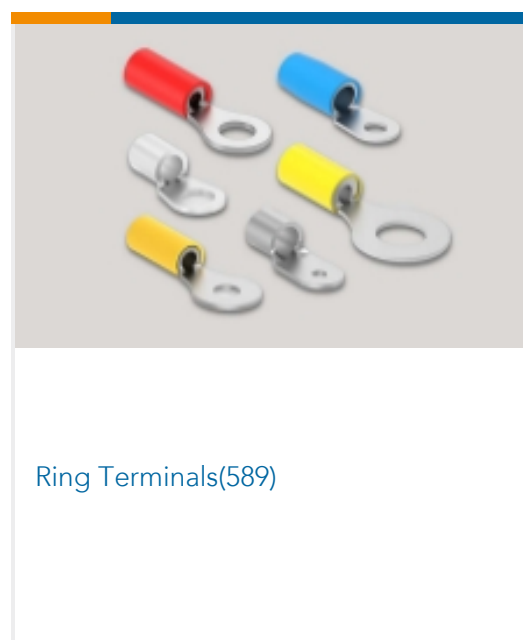
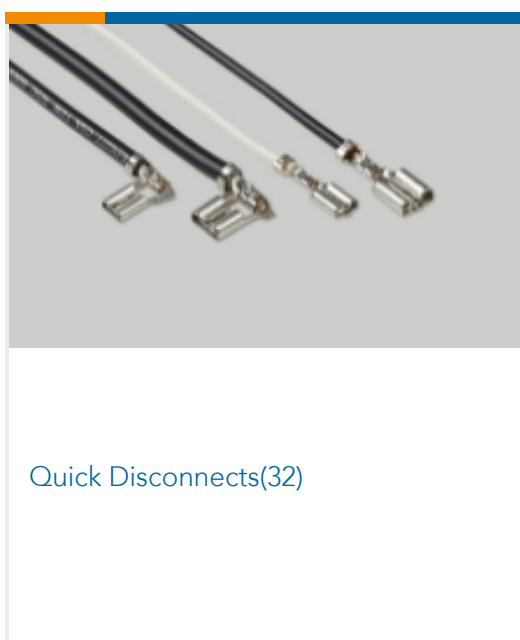
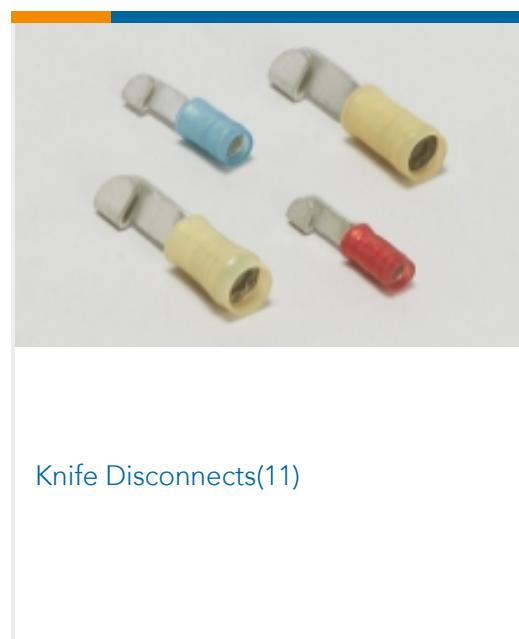
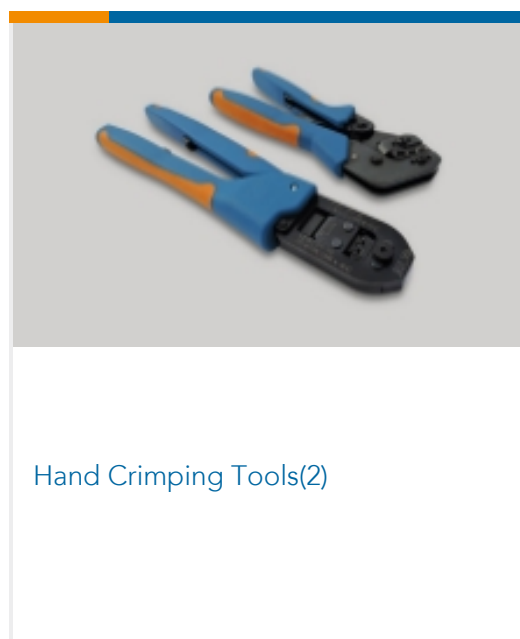
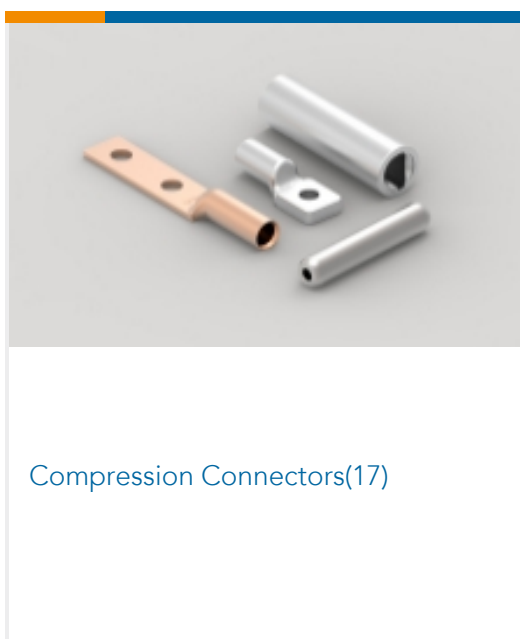



Splices(40)

Customers Also Bought

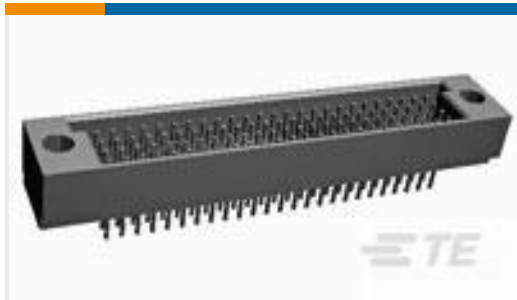
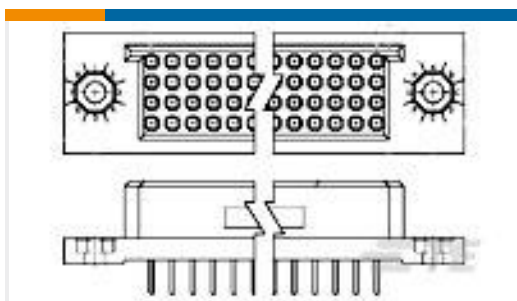
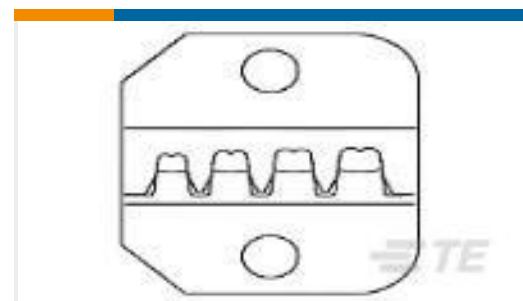
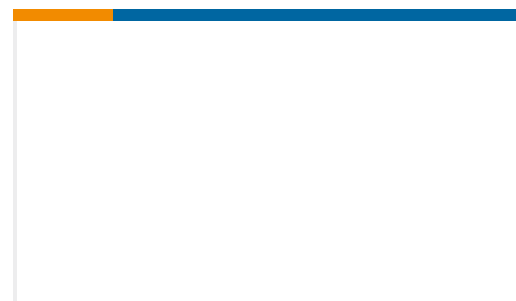
TE Part #532436-2
HDI PIN ASSY 4 ROW 120 POSTE Part #320568
PIDG Ring Tongue TerminalsTE Part #4-1617758-0
FCB-205-0208M=M83536/2-008MTE Part #2208335-1
RING TONGUE, CONTACTTE Part #533492-1
BOX II 4 ROW RECP ASSY 160 POSTE Part #318451-2
PROCIMP DIE ASSY, COMM BNCTE Part #1-582561-1
AMP-TAB ASSY 43 POS 100 C/L DUTE Part #EG6228-000
602A114-4-0

Documents

Product Drawings

TERM, RT, PIDG, 16-14, #8

English

CAD Files

3D PDF

3D

Customer View Model

[ENG_CVM_CVM_51864-1_AF.2d_dxf.zip](#)

English

Customer View Model

[ENG_CVM_CVM_51864-1_AF.3d_igs.zip](#)

English

Customer View Model

[ENG_CVM_CVM_51864-1_AF.3d_stp.zip](#)

English

By downloading the CAD file I accept and agree to the [Terms and Conditions](#) of use.



Datasheets & Catalog Pages

[PIDG TERMINALS & SPLICES Quick Reference Guide](#)

English

Agency Approvals

[UL Report](#)

English