

Click [here](#) to ask about the production status of specific part numbers.

MAX41400

Low-Power, Precision Instrumentation Amplifier with Programmable Gain

General Description

The MAX41400 is a low-power, high-precision instrumentation amplifier with programmable gain through input pins.

Available in a space-saving, 9-bump wafer-level package (WLP) with a 0.4mm bump pitch, it is designed for use in portable medical and industrial sensor applications.

The device features internal EMI filters to protect from RF disturbances and EMI. The internal fixed gain can be selected from 10V/V to 250V/V. The gain-setting resistors are located inside the device, thus minimizing gain drift variations over the temperature range.

The MAX41400 features rail-to-rail CMOS inputs and outputs; a 28kHz, -3dB bandwidth at just 65 μ A (typ) supply current; and 25 μ V (max) zero-drift input offset voltage over time and temperature. The zero-drift feature eliminates the high 1/f noise typically found in CMOS input amplifiers, making it useful for a wide variety of low-frequency measurement applications.

The MAX41400 operates from a 1.7V to 3.6V power supply voltage and is specified over the -40°C to +125°C automotive temperature range.

Applications

- Low-Power Sensor Interface
- Pressure, Weight, and Force Sensors
- RTD Temperature Sensors
- Wearable Devices
- EKG Medical Devices
- Insulin and Infusion Pumps

Benefits and Features

- Supply Voltage Range: 1.7V to 3.6V
- Very Low 25 μ V (max) Input Offset Voltage
- Low 65 μ A Quiescent Current
- Rail-to-Rail Inputs and Outputs
- EMIRR
 - >100dB at 1800MHz, 2400MHz
 - >90dB at 900MHz
- 28kHz, -3dB Bandwidth
- On-the-Fly Programmable Gain:
 - 10V/V, 20V/V, 40V/V, 80V/V, 100V/V, 150V/V, 200V/V, and 250V/V
- Power-Saving Shutdown Mode
- Available in Tiny 1.26mm x 1.23mm, 9-Bump WLP and 2.5mm x 2mm, 10-Pin TDFN

[Ordering Information](#) appears at end of data sheet.

Simplified Block Diagram

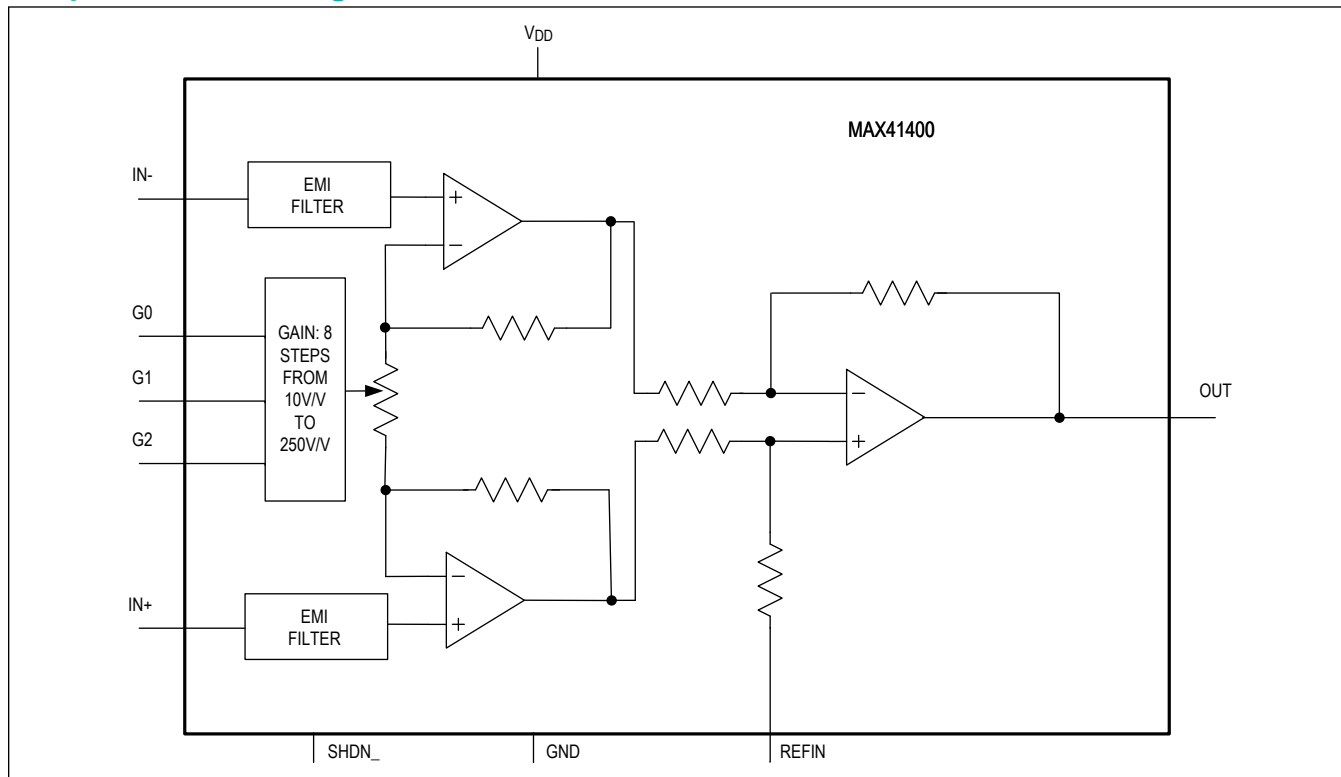

TABLE OF CONTENTS

General Description	1
Applications	1
Benefits and Features	1
Simplified Block Diagram	2
Absolute Maximum Ratings	6
Package Information	6
Ultra-Thin WLP	6
10 TDFN	6
Electrical Characteristics	6
Typical Operating Characteristics	9
Pin Configurations	13
WLP	13
TDFN	13
Pin Description	13
Detailed Description	14
Gain-Selection Inputs	14
Input Voltage Range	14
Input Stage and Output Stage Gain Setting	15
Input Common-Mode Range vs. Output Voltage Characterization	15
Shutdown Mode	16
External Noise Suppression in EMI Form	16
Input Offset Voltage	16
External Offset Adjustment	16
Applications Information	17
Gain-Selection Input Logic	17
Capacitive-Load Stability	17
Power Supplies and Layout	17
Transducer Applications	17
Typical Application Circuits	18
Transducer Application	18
PT100 Application	18
Ordering Information	19
Revision History	20

LIST OF FIGURES

Figure 1. MAX41400 Internal Configuration 15

Figure 2. Common-Mode Input Range over Output Swing 16

Figure 3. Strain Gauge Connection to MAX41400 18

Figure 4. Three-Wire PT100 Sensing Circuit 18

LIST OF TABLES

Table 1. Gain Selection (TDFN)	14
Table 2. Gain Selection (WLP)	14
Table 3. Input Stage and Output Stage Gain	15

Absolute Maximum Ratings

V_{DD} to GND.....	-0.3V to +4V	Continuous Power Dissipation (TDFN - derate 9.80mW/°C above +70°C).....	784mW
IN+ to IN-	-0.3V to $V_{DD} + 0.3V$	Operating Temperature Range	-40°C to +125°C
OUT, REF to GND.....	-0.3V to $V_{DD} + 0.3V$	Junction Temperature	+150°C
IN+, IN-, G0, G1, G2, SHDN_ to GND	-0.3V to $V_{DD} + 0.3V$	Storage Temperature Range	-40°C to +150°C
Continuous Current into any Input/Output Pin.....	10mA	Soldering Temperature (reflow)	+260°C
Output Short-Circuit Duration to Either V_{DD} or GND.. Continuous Power Dissipation (WLP - derate 11.91mW/°C above +70°C)	952.61mW		

Stresses beyond those listed under "Absolute Maximum Ratings" may cause permanent damage to the device. These are stress ratings only, and functional operation of the device at these or any other conditions beyond those indicated in the operational sections of the specifications is not implied. Exposure to absolute maximum rating conditions for extended periods may affect device reliability.

Package Information

Ultra-Thin WLP

Package Code	N91F1+1
Outline Number	21-100443
Land Pattern Number	Refer to Application Note 1891
Thermal Resistance, Four-Layer Board:	
Junction to Ambient (θ_{JA})	83.98°C/W
Junction to Case (θ_{JC})	24.60°C/W

10 TDFN

Package Code	T102A2+2C
Outline Number	21-100013
Land Pattern Number	90-100007
Thermal Resistance, Four-Layer Board:	
Junction to Ambient (θ_{JA})	102°C/W
Junction to Case (θ_{JC})	2.90°C/W

For the latest package outline information and land patterns (footprints), go to www.maximintegrated.com/packages. Note that a "+", "#", or "-" in the package code indicates RoHS status only. Package drawings may show a different suffix character, but the drawing pertains to the package regardless of RoHS status.

Package thermal resistances were obtained using the method described in JEDEC specification JESD51-7, using a four-layer board. For detailed information on package thermal considerations, refer to www.maximintegrated.com/thermal-tutorial.

Electrical Characteristics

(Global conditions unless otherwise stated: $V_{DD} = 1.8V$, $V_{IN+} = V_{IN-} = V_{DD}/2$, $V_{REFIN} = V_{DD}/2$, $G = 10V/V$, $R_{LOAD} = 10k\Omega$ to $V_{DD}/2$, $V_{SHDN-} = V_{DD}$, typical values at +25°C, -40°C $\leq T_A \leq$ +125°C)

PARAMETER	SYMBOL	CONDITIONS	MIN	TYP	MAX	UNITS
DC SPECIFICATIONS						
Input Offset Voltage	V_{OS}	-40°C $\leq T_A \leq$ +85°C	All gain options	1	25	μV
		-40°C $\leq T_A \leq$ +125°C	All gain options	1	35	
Input Offset Drift	TCV_{OS}			5		nV/°C
Input Bias Current	I_B	$T_A = +25^\circ C$	Note 1	10	150	pA
		-40°C $\leq T_A \leq$ +125°C	Note 1	10	300	

Electrical Characteristics (continued)

(Global conditions unless otherwise stated: $V_{DD} = 1.8V$, $V_{IN+} = V_{IN-} = V_{DD}/2$, $V_{REFIN} = V_{DD}/2$, $G = 10V/V$, $R_{LOAD} = 10k\Omega$ to $V_{DD}/2$, $V_{SHDN-} = V_{DD}$, typical values at $+25^{\circ}C$, $-40^{\circ}C \leq T_A \leq +125^{\circ}C$)

PARAMETER	SYMBOL	CONDITIONS		MIN	TYP	MAX	UNITS
Input Offset Current	I_{OS}	Note 1			10		pA
Input Common-Mode Range	V_{CM}	Guaranteed by CMRR		0.1		$V_{DD} - 0.1$	V
Input ESD Protections		HBM, both IN+ and IN-			2		kV
Common-Mode Rejection Ratio	CMRR	$-40^{\circ}C \leq T_A \leq +125^{\circ}C$	Gain = 10	106	120		dB
			Gain = 40	115	130		
			Gain = 100	120	130		
			Gain = 200	120	130		
Power-Supply Rejection Ratio	PSRR	$1.7V \leq V_{DD} \leq 3.6V$	Gain = 10	98	110		dB
			Gain = 40	110	120		
			Gain = 100	113	130		
			Gain = 200	113	130		
Range of Gain	G				WLP: 10, 40, 100, 200 TDFN: 10, 20, 40, 80, 100, 150, 200, 250	V/V	
Gain Selection Settling Time		V_{OUT} to settle within $\pm 100mV$			20		μs
Gain Error	GE	$-40^{\circ}C \leq T_A \leq +125^{\circ}C$	All gain options		0.05	0.18	%
Gain Error Tempco	TC_{GE}				5		ppm/ $^{\circ}C$
Output Voltage Swing High	V_{OH}	$V_{DD} - V_{OUT}$	$R_{LOAD} = 10k\Omega$ to $V_{DD}/2$			50	mV
Output Voltage Swing Low	V_{OL}	$V_{OUT} - GND$	$R_{LOAD} = 10k\Omega$ to $V_{DD}/2$			25	mV
INPUT REFERENCE							
Input Reference Voltage Range	V_{REFIN}			0		V_{DD}	V
AC SPECIFICATIONS							
Bandwidth, -3dB			Gain = 10		28		kHz
			Gain = 40		28		
			Gain = 100		10		
			Gain = 200		5		
Slew Rate	SR				0.08		V/ μs

Electrical Characteristics (continued)

(Global conditions unless otherwise stated: $V_{DD} = 1.8V$, $V_{IN+} = V_{IN-} = V_{DD}/2$, $V_{REFIN} = V_{DD}/2$, $G = 10V/V$, $R_{LOAD} = 10k\Omega$ to $V_{DD}/2$, $V_{SHDN} = V_{DD}$, typical values at $+25^{\circ}C$, $-40^{\circ}C \leq T_A \leq +125^{\circ}C$)

PARAMETER	SYMBOL	CONDITIONS		MIN	TYP	MAX	UNITS
Input Voltage-Noise Density	V_N	$f = 10Hz, 1kHz, 10kHz$	WLP: $G = 10V/V$ $G = 40V/V$ $G = 100V/V$ $G = 200V/V$ TDFN: $G = 20V/V$ $G = 80V/V$ $G = 150V/V$ $G = 250V/V$		WLP: 54 38 41 36 TDFN: 47 46 43 42		nV/\sqrt{Hz}
Input Voltage Noise		0.1Hz to 10Hz, gain = 10			1.3		μV_{P-P}
EMI Rejection Ratio	EMIRR	$V_{RFPEAK} = 100mV_{PK}$, $f = 900MHz$, both IN+ and IN-			>90		dB
		$V_{RFPEAK} = 100mV_{PK}$, $f = 1800MHz, 2400MHz$, both IN+ and IN-			>100		
Input Current-Noise Density	I_N	$f = 1kHz$			100		fA/\sqrt{Hz}
Capacitive Loading Stability	C_L				100		pF
POWER SUPPLY							
Supply Voltage	V_{DD}	Guaranteed by PSRR, $-40^{\circ}C \leq T_A \leq +125^{\circ}C$		1.7		3.6	V
Supply Current	I_{DD}				65	90	μA
Power-Up Time	t_{ON}	V_{OUT} to settle within 90%	$V_{DD} = 0$ to 1.8V step		100		μs
Shutdown Supply Current	I_{SHDN}	$-40^{\circ}C \leq T_A \leq +85^{\circ}C$	Note 1		0.1	0.3	μA
		$-40^{\circ}C \leq T_A \leq +125^{\circ}C$	Note 1		0.1	0.7	
Turn-On Time	t_{ONSD}	V_{OUT} to settle within 90%	$V_{DD} = 1.8V$, $V_{SHDN} = 0$ to 1.8V step in $<1\mu s$		100		μs
LOGIC INPUTS DC CHARACTERISTICS							
Input Low Level	V_{IL}	Active level				$0.3 \times V_{DD}$	V
Input High Level	V_{IH}				$0.7 \times V_{DD}$		V
Input Leakage Current	I_L					18	nA

Note 1: Guaranteed by design and characterization.

Typical Operating Characteristics

(Global conditions unless otherwise stated: $V_{DD} = 1.8V$, $V_{IN+} = V_{IN-} = V_{DD}/2$, $V_{REFIN} = V_{DD}/2$, $G = 10V/V$, $R_{LOAD} = 10k\Omega$ to $V_{DD}/2$, $V_{SHDN-} = V_{DD}$, typical values at $+25^{\circ}C$, $-40^{\circ}C \leq T_A \leq +125^{\circ}C$)

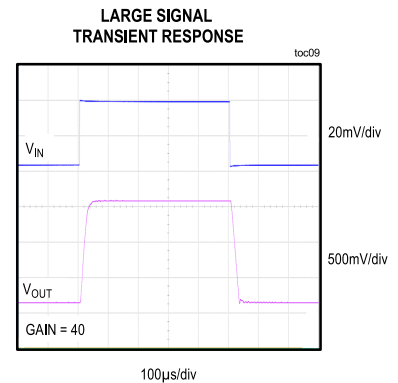
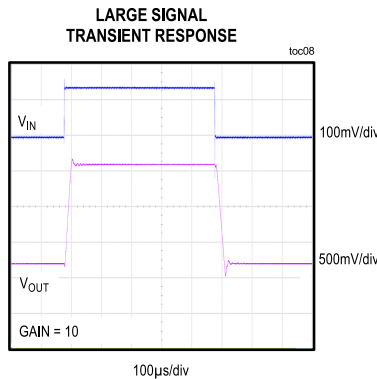
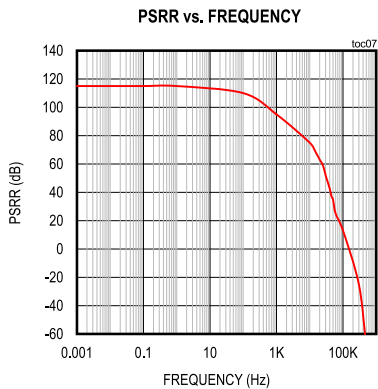
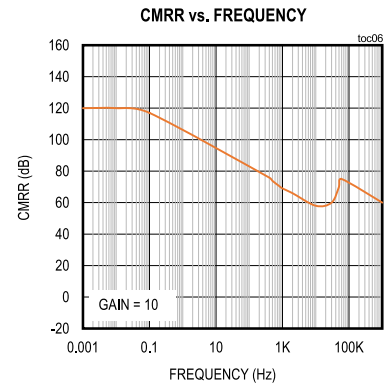
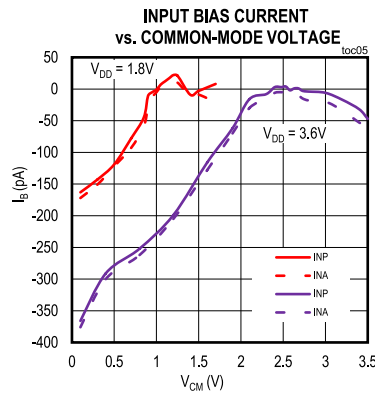
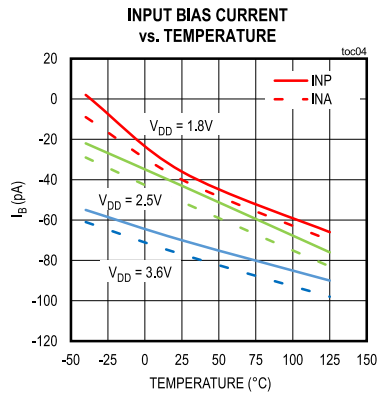
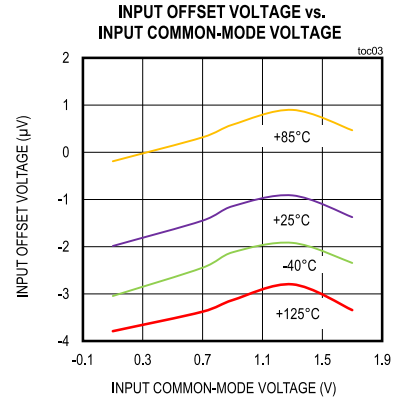
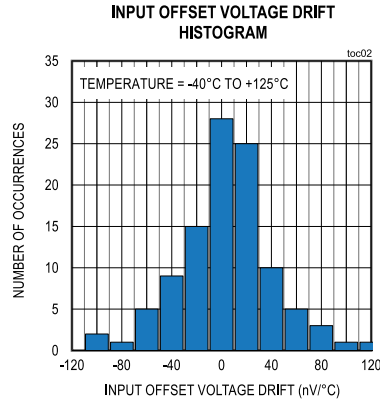
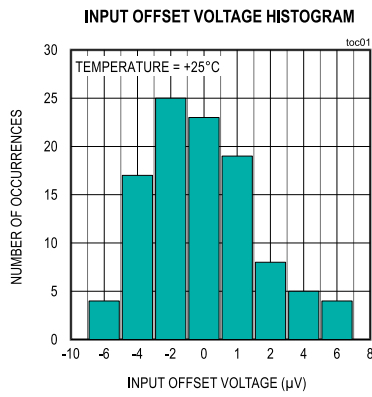

Typical Operating Characteristics (continued)

(Global conditions unless otherwise stated: $V_{DD} = 1.8V$, $V_{IN+} = V_{IN-} = V_{DD}/2$, $V_{REFIN} = V_{DD}/2$, $G = 10V/V$, $R_{LOAD} = 10k\Omega$ to $V_{DD}/2$, $V_{SHDN-} = V_{DD}$, typical values at $+25^{\circ}C$, $-40^{\circ}C \leq T_A \leq +125^{\circ}C$)

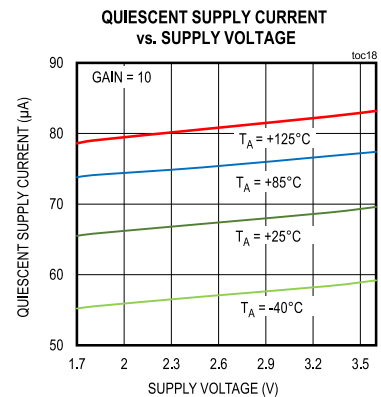
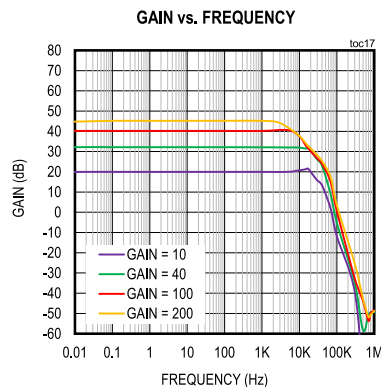
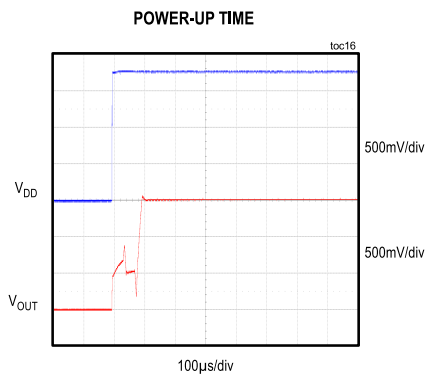
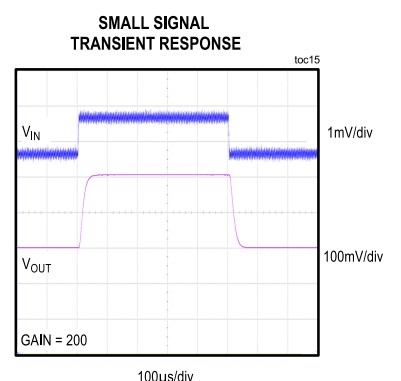
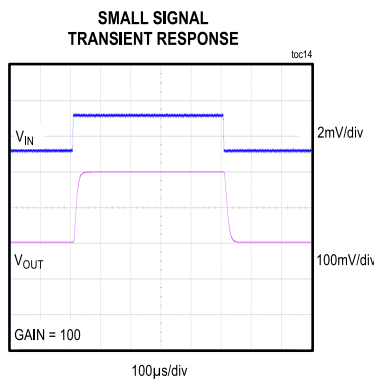
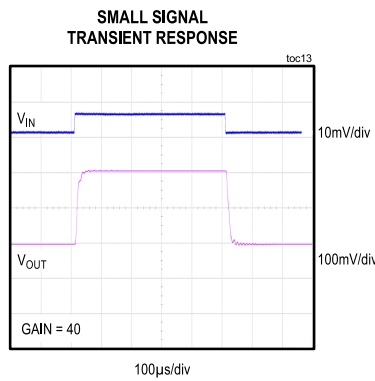
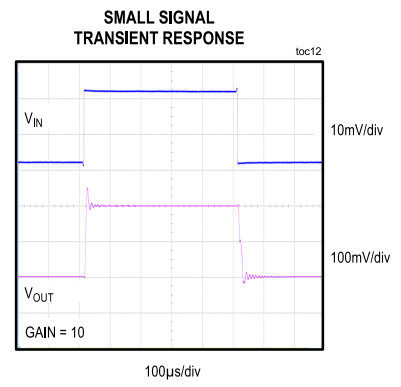
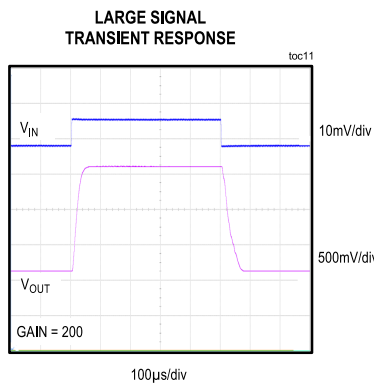
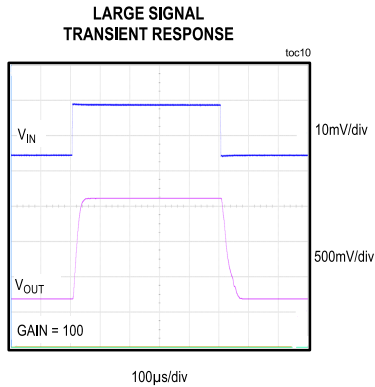

Typical Operating Characteristics (continued)

(Global conditions unless otherwise stated: $V_{DD} = 1.8V$, $V_{IN+} = V_{IN-} = V_{DD}/2$, $V_{REFIN} = V_{DD}/2$, $G = 10V/V$, $R_{LOAD} = 10k\Omega$ to $V_{DD}/2$, $V_{SHDN-} = V_{DD}$, typical values at $+25^{\circ}C$, $-40^{\circ}C \leq T_A \leq +125^{\circ}C$)

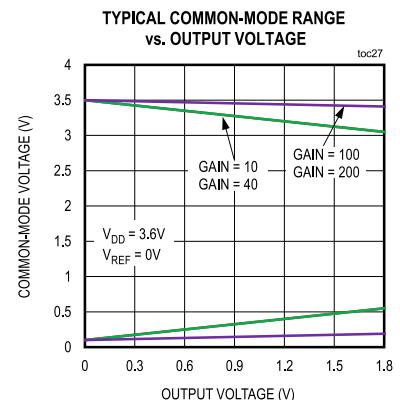
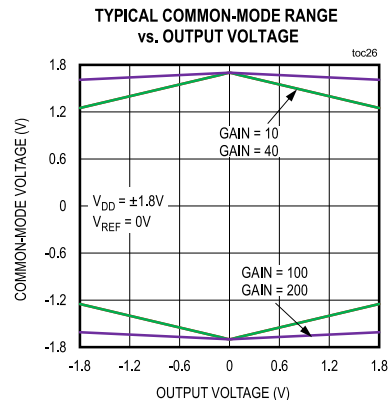
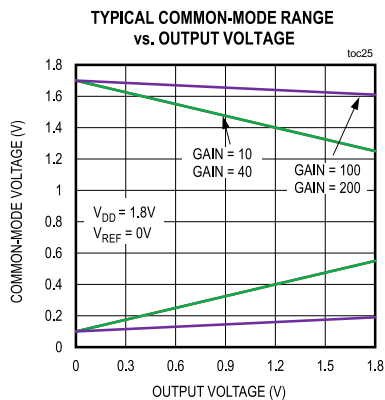
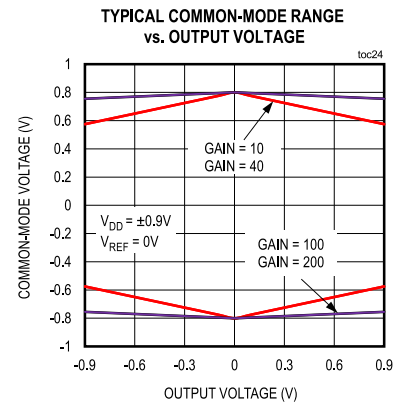
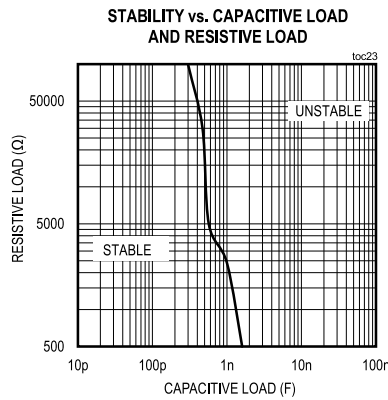
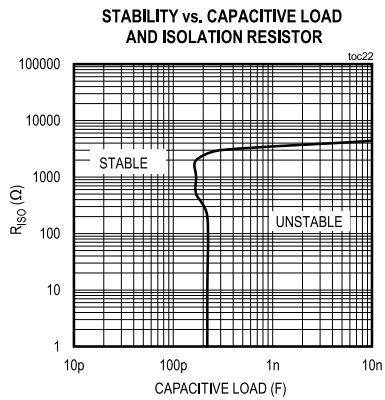
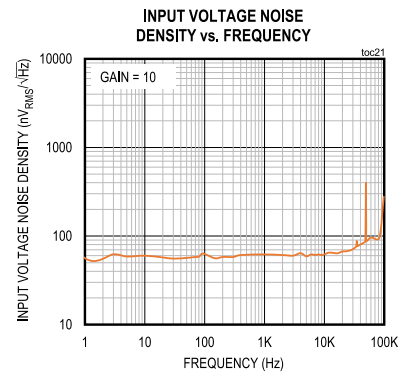
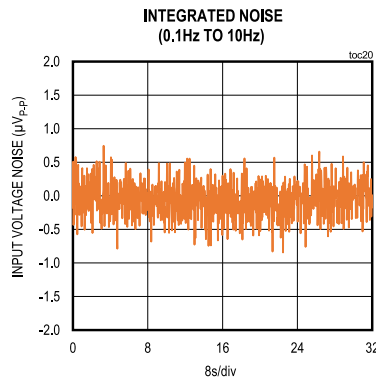
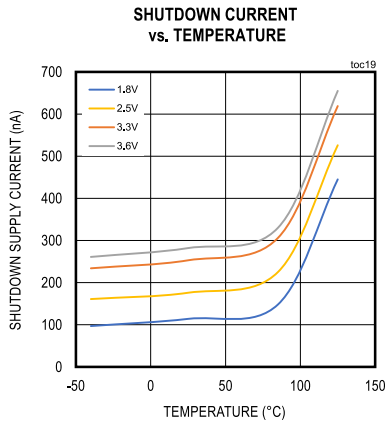

Typical Operating Characteristics (continued)

(Global conditions unless otherwise stated: $V_{DD} = 1.8V$, $V_{IN+} = V_{IN-} = V_{DD}/2$, $V_{REFIN} = V_{DD}/2$, $G = 10V/V$, $R_{LOAD} = 10k\Omega$ to $V_{DD}/2$, $V_{SHDN-} = V_{DD}$, typical values at $+25^{\circ}C$, $-40^{\circ}C \leq T_A \leq +125^{\circ}C$)

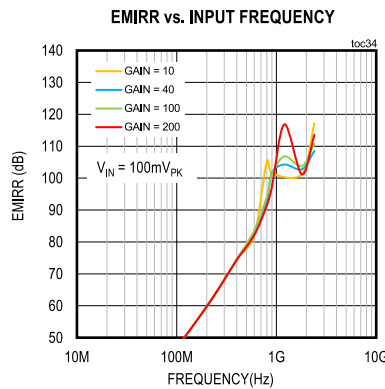
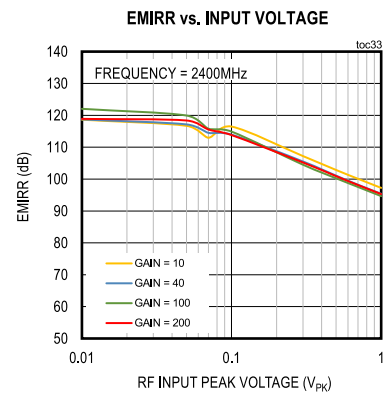
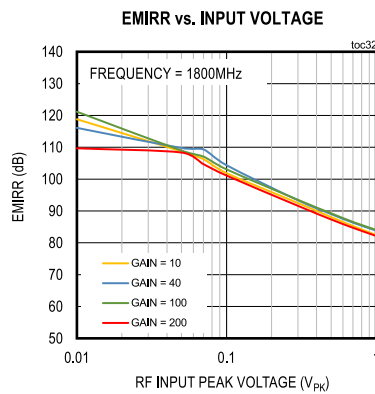
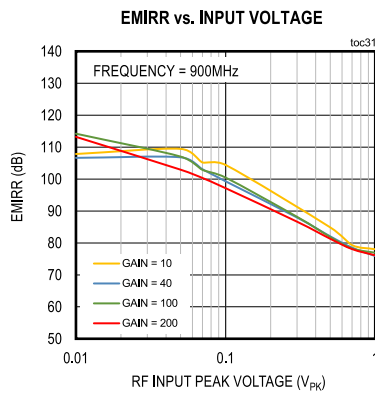
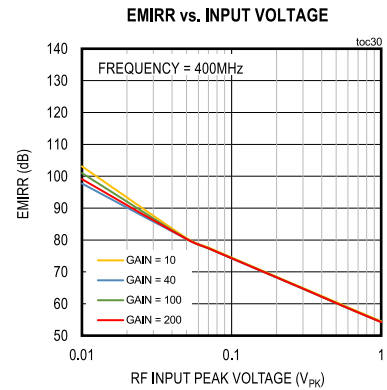
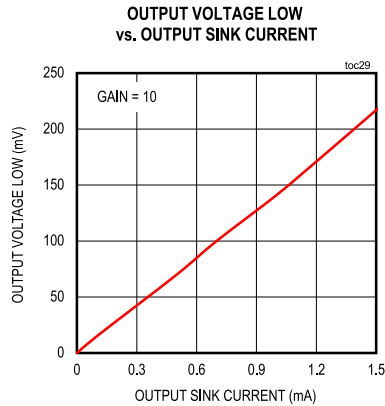
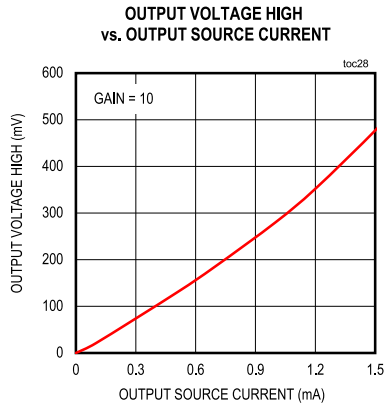

Pin Configurations

WLP

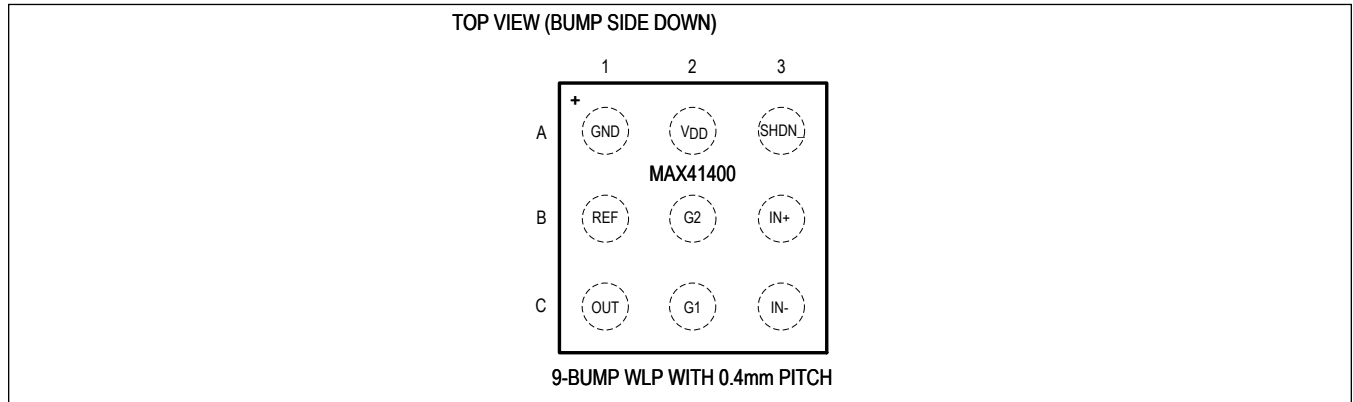

TDFN

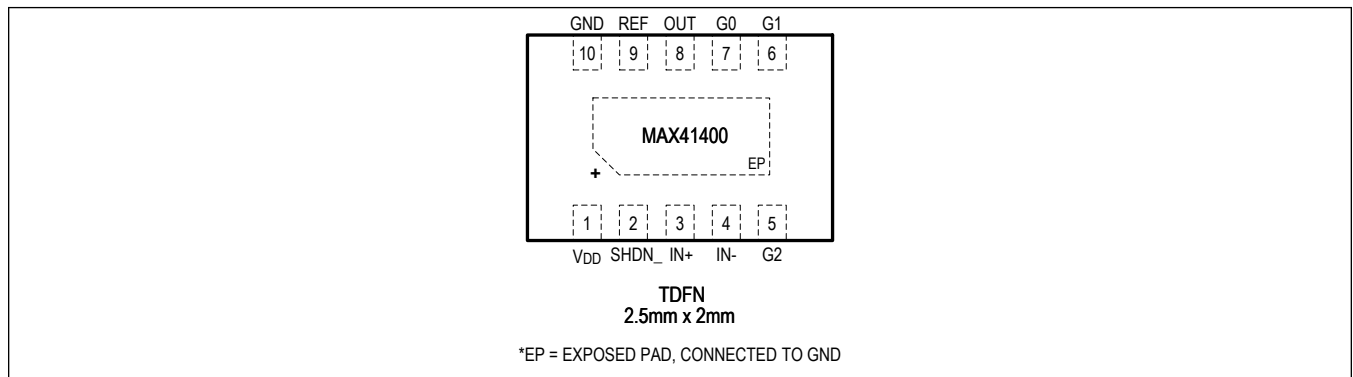

Pin Description

PIN		NAME	FUNCTION
WLP	TDFN		
B3	3	IN+	Noninverting Input
A1	10	GND	Ground
C3	4	IN-	Inverting Input
A2	1	V _{DD}	Positive Supply
C1	8	OUT	Output
A3	2	SHDN_	Shutdown (active low)
B1	9	REF	Input Reference
—	7	G0	Gain Selection Input. Connect to either V _{DD} or GND. The gain selection is based on the appropriate gain selection table in the Detailed Description .
C2	6	G1	Gain Selection Input. Connect to either V _{DD} or GND. The gain selection is based on the appropriate gain selection table in the Detailed Description .
B2	5	G2	Gain Selection Input. Connect to either V _{DD} or GND. The gain selection is based on the appropriate gain selection table in the Detailed Description .

Detailed Description

The MAX41400 is a programmable-gain precision instrumentation amplifier based on a traditional three-amplifier topology. The input stage is composed of two operational amplifiers that together provide a high common-mode rejection ratio, low input bias current, and low input offset voltage. The output stage is a conventional differential amplifier that provides an overall common-mode rejection of 130dB ($G = +10V/V$).

The amplifier has on-chip gain-setting resistors and the gains are selectable through input pins. On-chip trimming of internal gain-setting resistors helps optimize gain error, CMRR, and offset. Since all gain-setting resistors are within the device, this minimizes gain drift variation over the temperature range and saves design time and space.

Gain-Selection Inputs

Three inputs are used to select the internal gain for the TDFN package option. Each input can be connected to either GND or V_{DD} .

The WLP option supports only two inputs that limits gain selection to four options.

Table 1. Gain Selection (TDFN)

PACKAGE	G2	G1	G0	GAIN (V/V)
TDFN	GND	GND	GND	10
	GND	GND	V_{DD}	20
	GND	V_{DD}	GND	40
	GND	V_{DD}	V_{DD}	80
	V_{DD}	GND	GND	100
	V_{DD}	GND	V_{DD}	150
	V_{DD}	V_{DD}	GND	200
	V_{DD}	V_{DD}	V_{DD}	250

Table 2. Gain Selection (WLP)

PACKAGE	G2	G1	GAIN (V/V)
WLP	GND	GND	10
	GND	V_{DD}	40
	V_{DD}	GND	100
	V_{DD}	V_{DD}	200

Input Voltage Range

The common-mode input range for all of these amplifiers is $(V_{SS} + 0.1V)$ to $(V_{DD} - 0.1V)$. Ideally, the instrumentation amplifier responds only to a differential voltage applied to its inputs, $IN+$ and $IN-$. If both inputs are at the same voltage, the output is V_{REF} . A differential voltage at $IN+$ (V_{IN+}) and $IN-$ (V_{IN-}) develops an identical voltage across the gain-setting resistor, causing a current (I_G) to flow. This current also flows through the feedback resistors of the two input amplifiers A1 and A2, generating a differential voltage of:

$$V_{OUT2} - V_{OUT1} = I_G \times (R_1 + R_G + R_1)$$

where V_{OUT1} and V_{OUT2} are the output voltages of A1 and A2, R_G is the gain-setting resistor, and R_1 is the feedback resistor of the input amplifiers.

I_G is determined by the following equation:

$$I_G = (V_{IN+} - V_{IN-})/R_G$$

The output voltage (V_{OUT}) for the instrumentation amplifier is expressed in the following equation:

$$V_{OUT} = (V_{IN+} - V_{IN-}) \times (2 \times \frac{R_1}{R_G} + 1) \times \frac{R_3}{R_2}$$

The common-mode input range is a function of the amplifier's output voltage and the supply voltage. With a power supply of V_{DD} , the largest output signal swing can be obtained with REF tied to $V_{DD}/2$. This results in an output-voltage swing of $\pm V_{DD}/2$. An output-voltage swing less than full scale increases the common-mode input range.

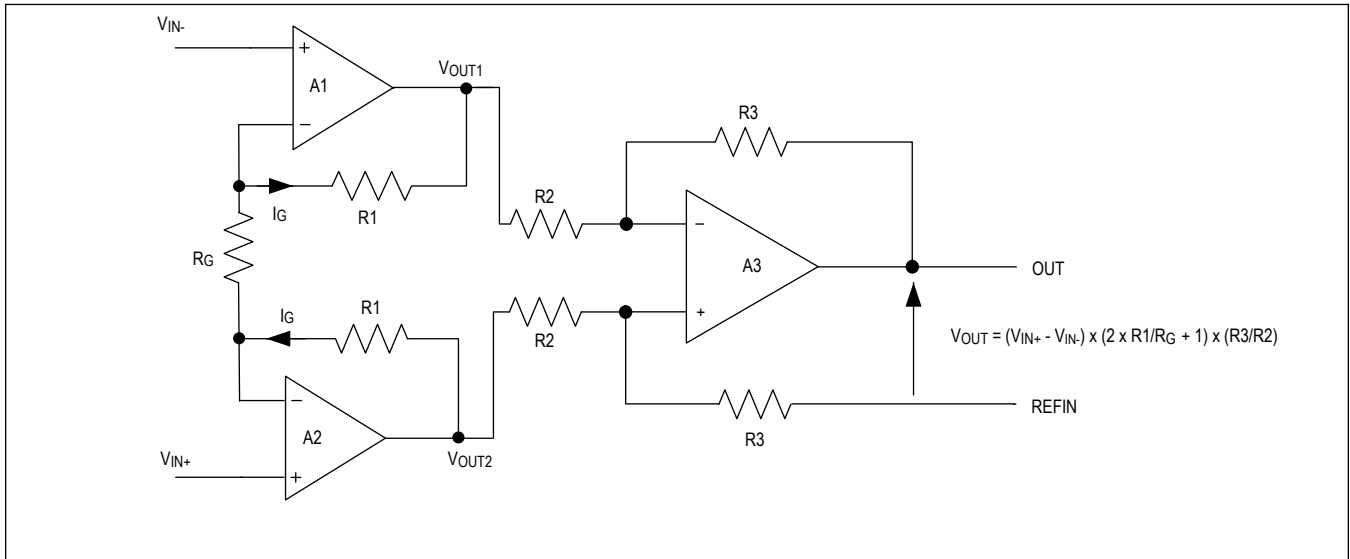

Figure 1. MAX41400 Internal Configuration

Input Stage and Output Stage Gain Setting

When R2 and R3 are not equally set at the output stage, the MAX41400's gain is determined by the gain of both the input stage (A1) and output stage (A2) amplifiers. At a different gain setting, internal R1, R_G , R2, and R3 are selected respectively. Table 3 shows the input and output stage gain settings with respect to the total gain of the MAX41400.

Table 3. Input Stage and Output Stage Gain

G2	G1	G0	GAIN1 INPUT STAGE	GAIN2 OUTPUT STAGE	GAIN
GND	GND	GND	5	2	10
GND	GND	V_{DD}	10	2	20
GND	V_{DD}	GND	20	2	40
GND	V_{DD}	V_{DD}	8	10	80
V_{DD}	GND	GND	10	10	100
V_{DD}	GND	V_{DD}	15	10	150
V_{DD}	V_{DD}	GND	20	10	200
V_{DD}	V_{DD}	V_{DD}	25	10	250

Input Common-Mode Range vs. Output Voltage Characterization

Figure 2 illustrates the MAX41400's typical common-mode input voltage range over the output voltage swing at a different gain. Although the common-mode input range for all three amplifiers is $(V_{SS} + 0.1V)$ to $(V_{DD} - 0.1V)$, the common-mode input voltage range of MAX41400 is changed with the amplifier's output voltage and gain setting. The reason is, as the input stage's operational amplifiers A1 and A2 amplify the differential input voltage, the common-mode input voltage range of the MAX41400 is limited by the output stage differential amplifier's linear input range. For example, with gain = 10, when the output voltage is 0.9V, the MAX41400's common-mode input voltage range is determined by the input range of the output amps ($\pm 0.8V$) minus the amplified differential input amplitude at the output amps ($\pm 0.225V$). For a higher gain configuration, the V_{CM} range will increase, since a smaller differential voltage is necessary for the given output voltage.

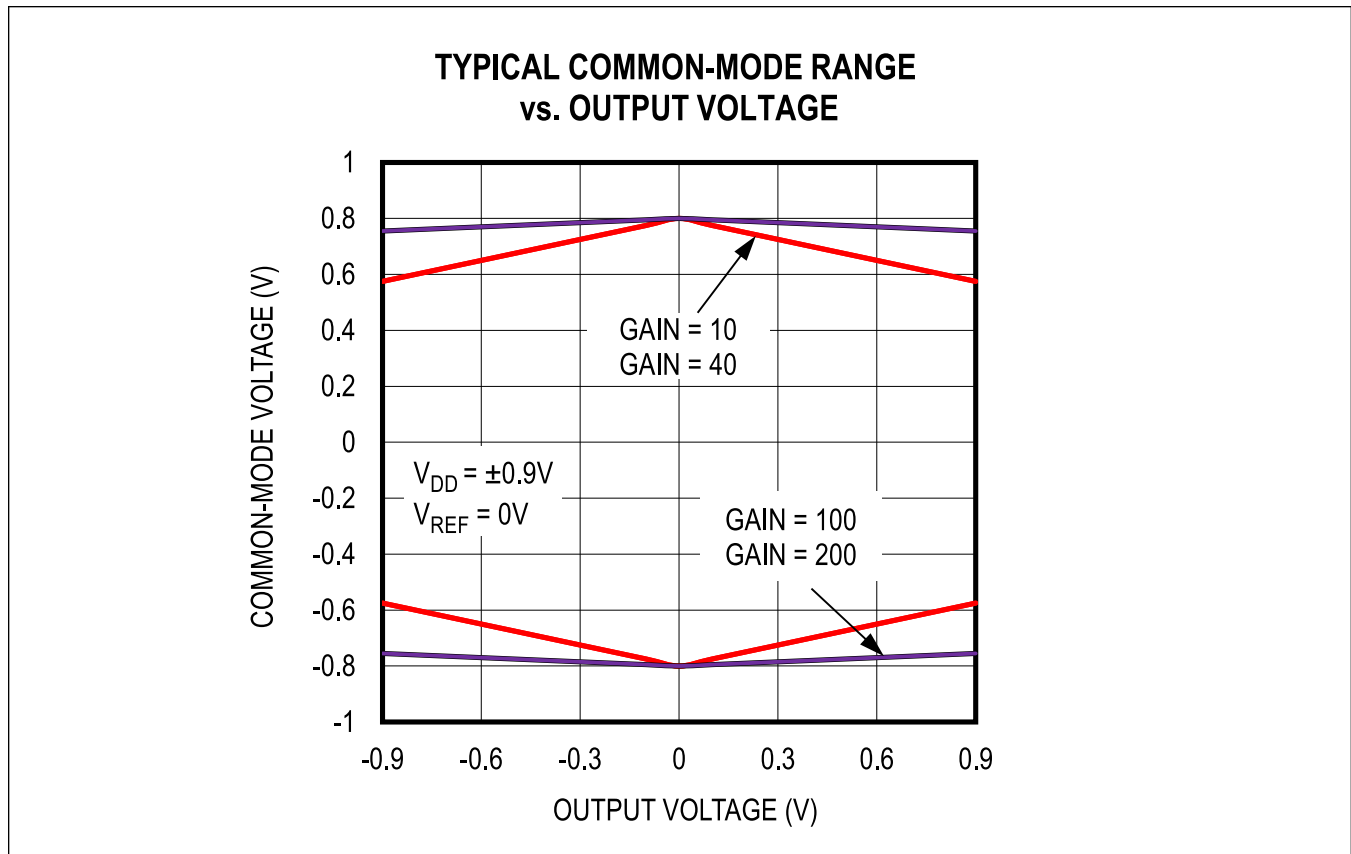

Figure 2. Common-Mode Input Range over Output Swing

Shutdown Mode

The MAX41400 features a low-power shutdown mode. When the shutdown pin ($\overline{\text{SHDN}}$) is pulled low, the internal amplifiers are switched off and the supply current drops to $0.1\mu\text{A}$, typ. This disables the instrumentation amplifier and puts its output in a high-impedance state. Pulling $\overline{\text{SHDN}}$ high enables the instrumentation amplifier.

External Noise Suppression in EMI Form

The MAX41400 has input EMI filters to prevent effects of radio frequency interference on the output. The EMI filters comprise passive devices that present significantly higher impedance to higher frequency signals.

Input Offset Voltage

The MAX41400 features a chop structure, which reduces input offset voltage and $1/f$ noise while reducing the output ripple typically associated with chopping circuits. The output stage resistor bridge is carefully trimmed to reduce the offset introduced by the mismatch of the resistor network.

External Offset Adjustment

If necessary, external offset can be adjusted by applying a voltage at the REF pin. The voltage applied at the REF pin is required to have a low output impedance (i.e., lower than 10Ω) in order to provide high common-mode rejection.

Applications Information

Gain-Selection Input Logic

The MAX41400 features a digitally adjustable gain-selection input (G0,G1,G2), which allows changing the instrumentation amplifier gain without an external gain setting resistor, thus minimizing gain drift variation over the temperature range and saving design time and space.

Input low level (V_{IL}) and input high level (V_{IH}) determine the threshold for gain-selection input to recognize a valid logic state. With three gain-selection inputs (TDFN) and two gain-selection inputs (WLP) available, the MAX41400 supports eight gain settings (TDFN) and four gain settings (WLP) respectively.

The logic state of the gain-selection input can be achieved by connecting the input pin to either GND or V_{DD} or can be controlled by a microcontroller. Note that the logic threshold is referred to the negative supply rail of the MAX41400 for dual-supply operation.

Capacitive-Load Stability

The MAX41400 is stable for capacitive loads up to 100pF. Applications that require greater capacitive-load driving capability can use an isolation resistor between the output and the capacitive load to reduce ringing on the output signal. However, this alternative reduces gain accuracy because R_{ISO} forms a potential divider with the load resistor.

Power Supplies and Layout

The MAX41400 operates either with a single supply from +1.7V to +3.6V with respect to ground or with dual supplies from $\pm 0.85V$ to $\pm 1.8V$. For best performance, bypass each power supply to ground with a separate 0.1 μF capacitor.

Good layout technique optimizes performance by decreasing the amount of stray capacitance at the instrumentation amplifier's input. Excess capacitance will produce peaking in the amplifier's frequency response. To decrease stray capacitance, minimize trace lengths by placing external components as close to the instrumentation amplifier as possible.

Transducer Applications

The MAX41400 can be used in various signal-conditioning circuits for thermocouples, PT100s, strain gauges (displacement sensors), piezoresistive transducers (PRTs), flow sensors, and bioelectrical applications. [Figure 3](#) shows a simplified example of how to attach four strain gauges (two identical two-element strain gauges) to the inputs of the MAX41400. The bridge contains four resistors, two of which increase and two of which decrease by the same ratio.

With a fully balanced bridge, points A (IN+) and B (IN-) see half of the the excitation voltage (V_{BRIDGE}). The low impedance (120 Ω to 350 Ω) of the strain gauges, however, could cause significant voltage drop contributions by the wires leading to the bridge, which would cause excitation variations. The output voltage (V_{OUT}) can be calculated as follows:

$$V_{OUT} = V_{AB} \times G$$

where G is the gain of the MAX41400.

Typical Application Circuits

Transducer Application

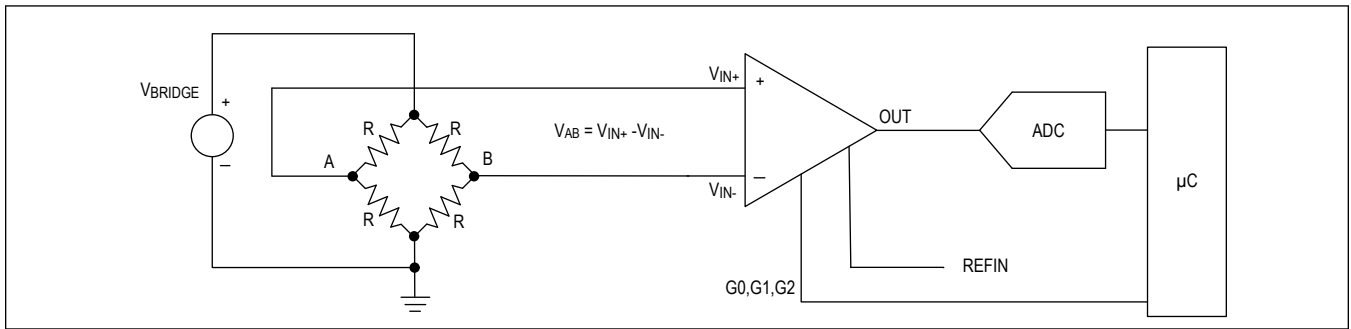

Figure 3. Strain Gauge Connection to MAX41400

PT100 Application

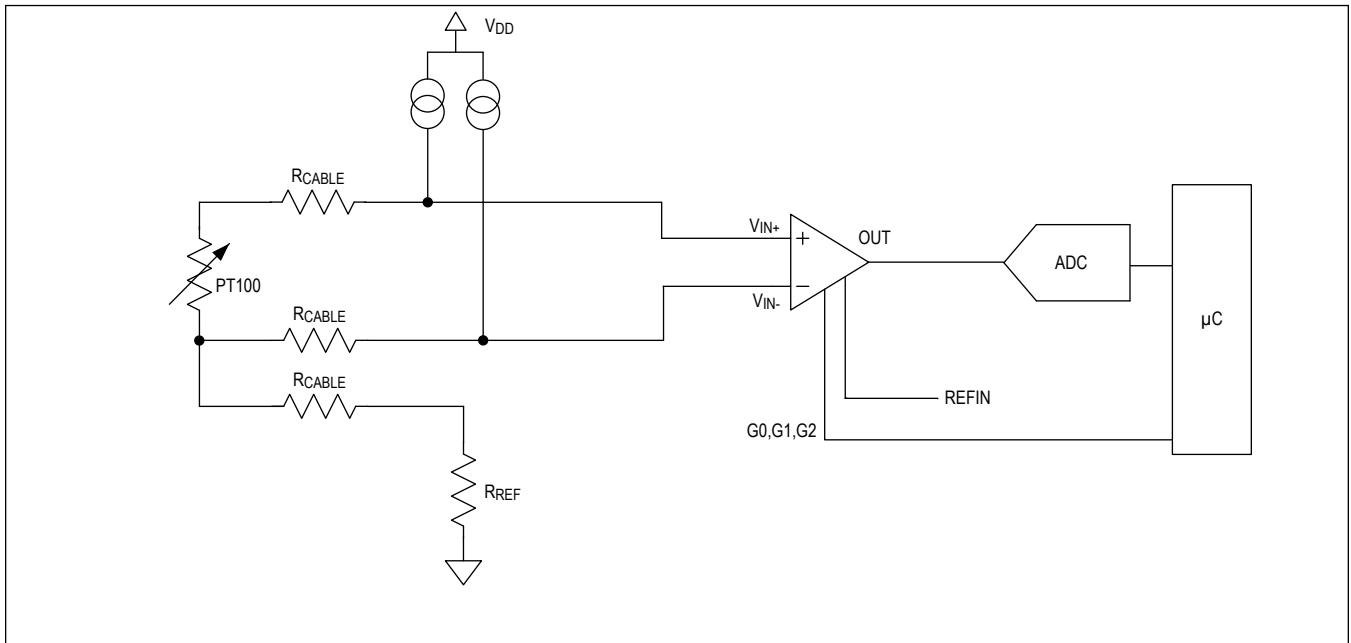

Figure 4. Three-Wire PT100 Sensing Circuit

Ordering Information

PART NUMBER	TEMP RANGE	PIN-PACKAGE	TOP MARKING
MAX41400ANL+	-40°C to +125°C	9 WLP	+AAS
MAX41400ANL+T	-40°C to +125°C	9 WLP	+AAS
MAX41400ATB+*	-40°C to +125°C	10 TDFN	+AZN
MAX41400ATB+T*	-40°C to +125°C	10 TDFN	+AZN

+ Denotes a lead(Pb)-free/RoHS-compliant package.

T = Tape-and-reel.

*Future product—contact factory for availability.

Revision History

REVISION NUMBER	REVISION DATE	DESCRIPTION	PAGES CHANGED
0	10/20	Release for intro	—
1	1/21	Updated Electrical Characteristics table, Typical Operating Characteristics	8, 11, 12
2	7/21	Updated <i>Benefits and Features</i> , Electrical Characteristics table, Typical Operating Characteristics	1, 8, 9, 12

For pricing, delivery, and ordering information, please visit Maxim Integrated's online storefront at <https://www.maximintegrated.com/en/storefront/storefront.html>.

Maxim Integrated cannot assume responsibility for use of any circuitry other than circuitry entirely embodied in a Maxim Integrated product. No circuit patent licenses are implied. Maxim Integrated reserves the right to change the circuitry and specifications without notice at any time. The parametric values (min and max limits) shown in the Electrical Characteristics table are guaranteed. Other parametric values quoted in this data sheet are provided for guidance.