



SGM2020

Low Power, Low Dropout, RF - Linear Regulators

GENERAL DESCRIPTION

The SGM2020 series low-power, low-noise, low-dropout, CMOS linear voltage regulators operate from a 2.5V to 5.5V input voltage. They are the perfect choice for low voltage, low power applications. A low ground current makes this part attractive for battery operated power systems. The SGM2020 series also offer ultra low dropout voltage to prolong battery life in portable electronics. Systems requiring a quiet voltage source, such as RF applications, will benefit from the SGM2020 series' ultra low output noise ($30\mu V_{RMS}$) and high PSRR. An external noise bypass capacitor connected to the device's BP pin can further reduce the noise level.

Other features include a 10nA logic- controlled shutdown mode, foldback current limit and thermal shut-down protection.

The SGM2020 is available in Green SOT-23-5 and SC70-5 packages. It operates over an ambient temperature range of $-40^{\circ}C$ to $+85^{\circ}C$.

APPLICATIONS

- Cellular Telephones
- Cordless Telephones
- PHS Telephones
- PCMCIA Cards
- Modems
- MP3 Player
- Hand-Held Instruments
- Palmtop Computers
- Electronic Planners
- Portable/Battery-Powered Equipment

FEATURES

- **Low Output Noise:**
 $30\mu V_{RMS}$ TYP (10Hz to 100kHz)
- **Low Dropout Voltage**
- **Low 110 μ A No-Load Supply Current**
- **Quick Auto-Discharge in Shutdown Status**
- **High PSRR (67dB at 1kHz)**
- **Thermal-Overload Protection**
- **Output Current Limit**
- **10nA Logic-Controlled Shutdown**
- **Available in Multiple Output Voltage Versions**
Fixed Outputs of 1.2V, 1.5V, 1.8V, 2.5V, 2.8V, 2.85V, 3.0V and 3.3V
- **$-40^{\circ}C$ to $+85^{\circ}C$ Operating Temperature Range**
- **Green SOT-23-5 and SC70-5 Packages**

PRODUCT NAME STRUCTURE

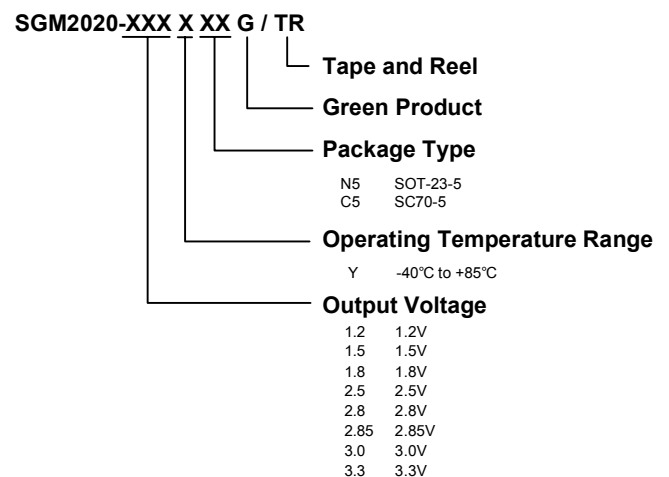

ABSOLUTE MAXIMUM RATINGS

IN to GND.....	-0.3V to 6V
Output Short-Circuit Duration	Infinite
EN to GND.....	-0.3V to V_{IN}
OUT, BP to GND.....	-0.3V to $(V_{IN} + 0.3V)$
Operating Temperature Range.....	-40°C to +85°C
Junction Temperature.....	150°C
Storage Temperature.....	-65°C to +150°C
Lead Temperature (soldering, 10s).....	260°C
ESD Susceptibility	
HBM.....	4000V
MM.....	400V

Stresses beyond those listed under “Absolute Maximum Ratings” may cause permanent damage to the device. These are stress ratings only, and functional operation of the device at these or any other conditions beyond those indicated in the operational sections of the specifications is not implied. Exposure to absolute maximum rating conditions for extended periods may affect device reliability.

TYPICAL APPLICATION CIRCUIT

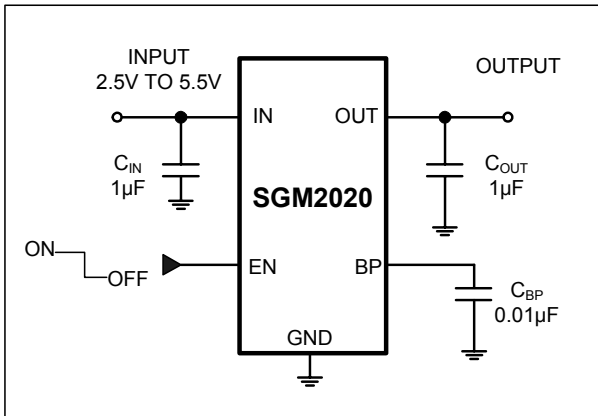

PIN DESCRIPTION

SOT-23-5/SC70-5	NAME	FUNCTION
1	IN	Regulator Input. Supply voltage can range from 2.5V to 5.5V. Bypass with a 1µF capacitor to GND.
2	GND	Ground.
3	EN	Shutdown Input. A logic low reduces the supply current to 10nA. Connect to IN for normal operation.
4	BP	Reference-Noise Bypass (fixed voltage version only). Bypass with a low-leakage 0.01µF ceramic capacitor for reduced noise at the output.
5	OUT	Regulator Output.

CAUTION

This integrated circuit can be damaged by ESD if you don't pay attention to ESD protection. SGMICRO recommends that all integrated circuits be handled with appropriate precautions. Failure to observe proper handling and installation procedures can cause damage. ESD damage can range from subtle performance degradation to complete device failure. Precision integrated circuits may be more susceptible to damage because very small parametric changes could cause the device not to meet its published specifications.

SGMICRO reserves the right to make any change in circuit design, specification or other related things if necessary without notice at any time. Please contact SGMICRO sales office to get the last datasheet.

PIN CONFIGURATIONS (TOP VIEW)

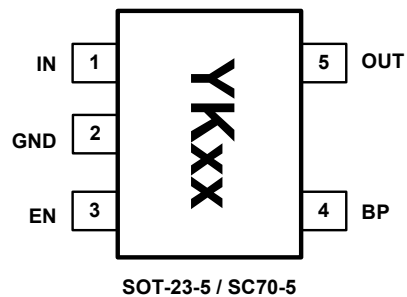

NOTE1: The location of pin 1 on the YKxx is determined by orienting the package marking as shown.

NOTE2: “xx” is the output voltage code. (For Example: when the output voltage is 2.8V, it is expressed as 28.)

ELECTRICAL CHARACTERISTICS(V_{IN} = V_{OUT (NOMINAL)} + 0.5V⁽¹⁾, Full = -40°C to +85°C, unless otherwise noted.)

PARAMETER	SYMBOL	CONDITIONS	TEMP	MIN	TYP	MAX	UNITS	
Input Voltage	V _{IN}		+25°C	2.5		5.5	V	
Output Voltage Accuracy ⁽¹⁾		I _{OUT} = 0.1mA	+25°C	-2		+2	%	
Maximum Output Current		SOT-23-5	+25°C	300			mA	
		V _{OUT} = 1.8V, SC70-5 ⁽¹⁾		150				
		V _{OUT} > 2V, SC70-5 ⁽¹⁾		250				
Current Limit	I _{LIM}		+25°C	310	500		mA	
Ground Pin Current	I _Q	No load, EN = 2V	+25°C		110	220	µA	
Dropout Voltage ⁽²⁾		I _{OUT} = 1mA	+25°C		1		mV	
		I _{OUT} = 300mA			270	400		
On Resistance of Nch for Auto-Discharge	R _{LOW}	EN = 0V	+25°C		48		Ω	
Line Regulation ⁽¹⁾		V _{IN} = 2.5V or (V _{OUT} + 0.5V) to 5.5V, I _{OUT} = 1mA	+25°C		0.02	0.06	%/V	
Load Regulation		I _{OUT} = 0.1mA to 300mA, C _{OUT} = 1µF, V _{OUT} > 2V	+25°C		0.002	0.006	%/mA	
		I _{OUT} = 0.1mA to 300mA, C _{OUT} = 1µF, V _{OUT} ≤ 2V			0.004	0.01		
Output Voltage Noise	e _n	f = 10Hz to 100kHz, C _{BP} = 0.01µF, C _{OUT} = 10µF	+25°C		30		µV _{RMS}	
Power Supply Rejection Rate	PSRR	C _{BP} = 0.1µF, I _{LOAD} = 50mA, C _{OUT} = 1µF, V _{IN} = V _{OUT} +1V	f = 217Hz	+25°C		73		dB
			f = 1kHz	+25°C		67		dB
SHUTDOWN⁽³⁾								
EN Input Threshold	V _{IH}	V _{IN} = 2.5V to 5.5V	Full	1.5			V	
	V _{IL}		Full			0.3		
EN Input Bias Current	I _{B(SHDN)}	EN = 0V and EN = 5.5V	+25°C		0.01	1	µA	
			Full		0.01			
Shutdown Supply Current	I _{Q(SHDN)}	EN = 0.4V	+25°C		0.01	1	µA	
			Full		0.01			
Shutdown Exit Delay ⁽⁴⁾		C _{BP} = 0.01µF, C _{OUT} = 1µF, No Load	+25°C		30		µs	
THERMAL PROTECTION								
Thermal Shutdown Temperature	T _{SHDN}				150		°C	
Thermal Shutdown Hysteresis	ΔT _{SHDN}				15		°C	

NOTE 1: V_{IN} = V_{OUT (NOMINAL)} + 0.5V or 2.5V, whichever is greater.NOTE 2: The dropout voltage is defined as V_{IN} - V_{OUT}, when V_{OUT} is 100mV below the value of V_{OUT} for V_{IN} = V_{OUT} + 0.5V. (Only applicable for V_{OUT} = +2.5V to +5.0V.)NOTE 3: V_{EN} = -0.3V to V_{IN}NOTE 4: Time needed for V_{OUT} to reach 90% of final value.

TYPICAL OPERATING CHARACTERISTICS

$V_{IN} = V_{OUT(NOMINAL)} + 0.5V$ or $2.5V$ (whichever is greater), $C_{IN} = 1\mu F$, $C_{OUT} = 1\mu F$, $C_{BP} = 0.01\mu F$, $T_A = +25^\circ C$, unless otherwise noted.

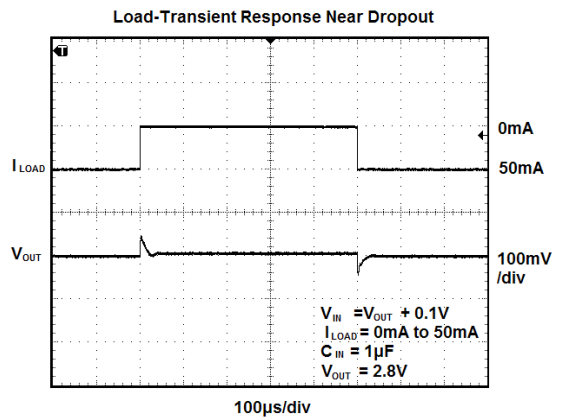
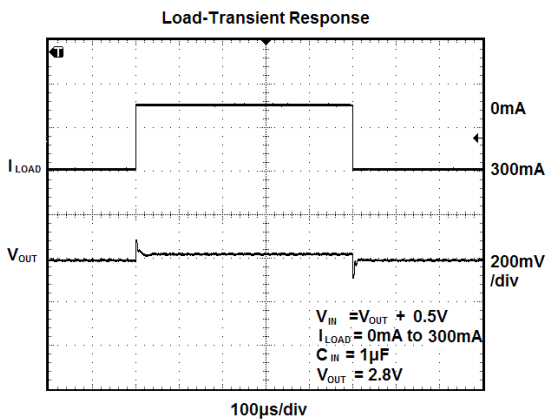
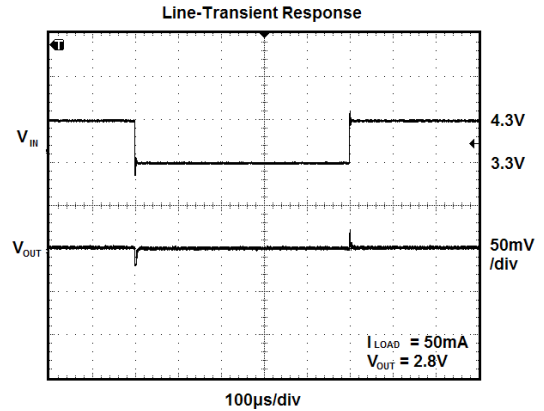
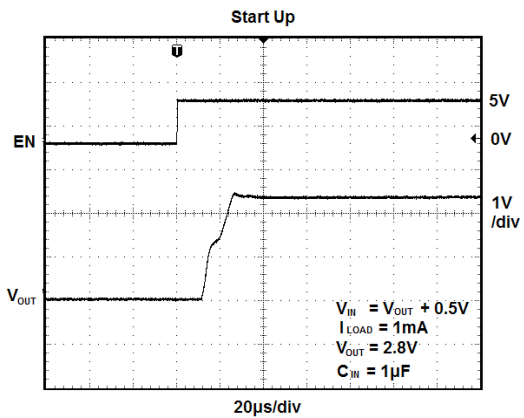
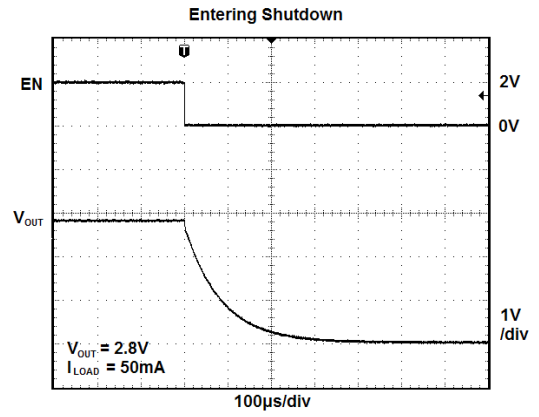
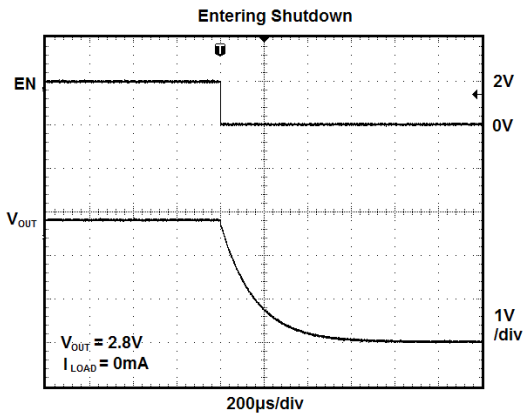

TYPICAL OPERATING CHARACTERISTICS

$V_{IN} = V_{OUT(NOMINAL)} + 0.5V$ or $2.5V$ (whichever is greater), $C_{IN} = 1\mu F$, $C_{OUT} = 1\mu F$, $C_{BP} = 0.01\mu F$, $T_A = +25^\circ C$, unless otherwise noted.

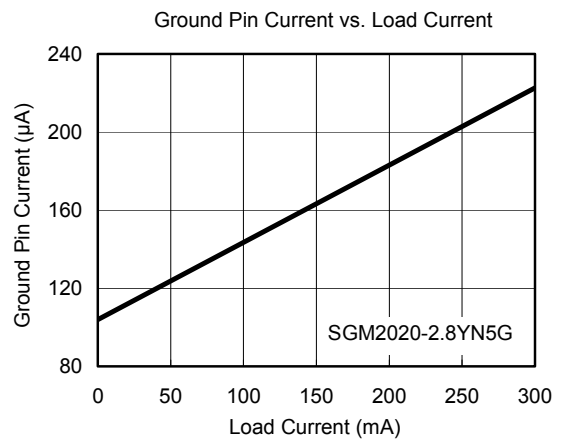
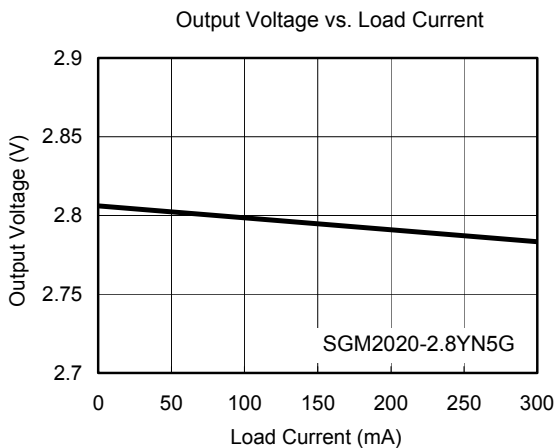
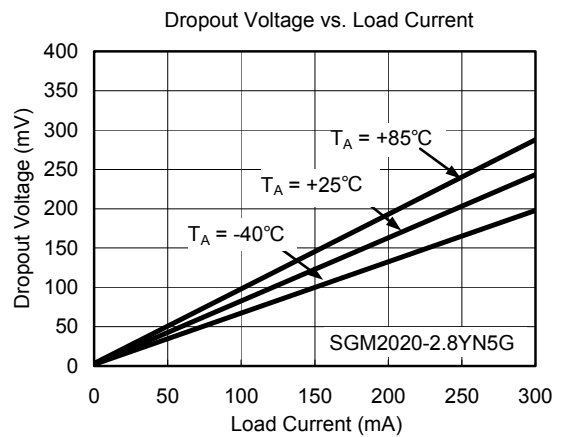
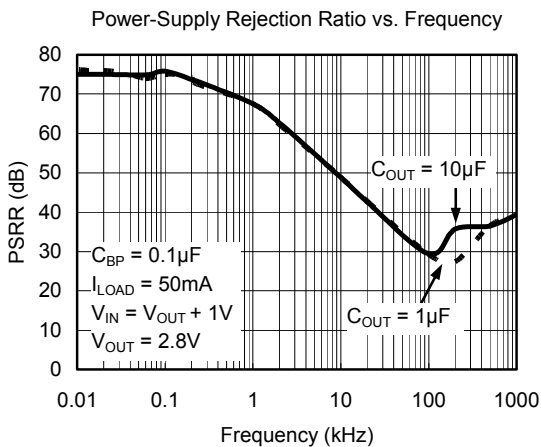
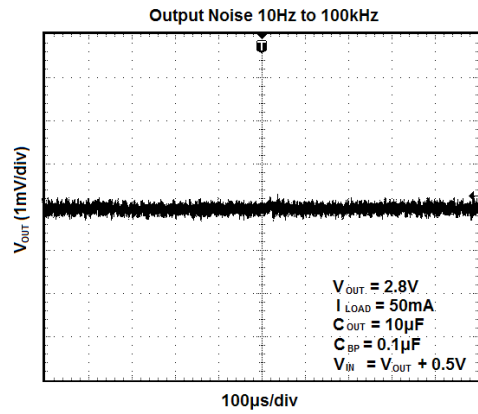
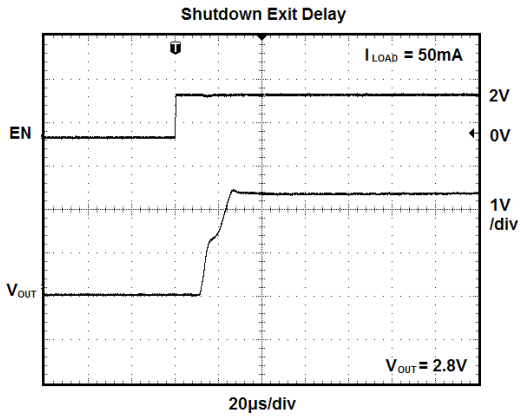

TYPICAL OPERATING CHARACTERISTICS

$V_{IN} = V_{OUT(NOMINAL)} + 0.5V$ or $2.5V$ (whichever is greater), $C_{IN} = 1\mu F$, $C_{OUT} = 1\mu F$, $C_{BP} = 0.01\mu F$, $T_A = +25^\circ C$, unless otherwise noted.

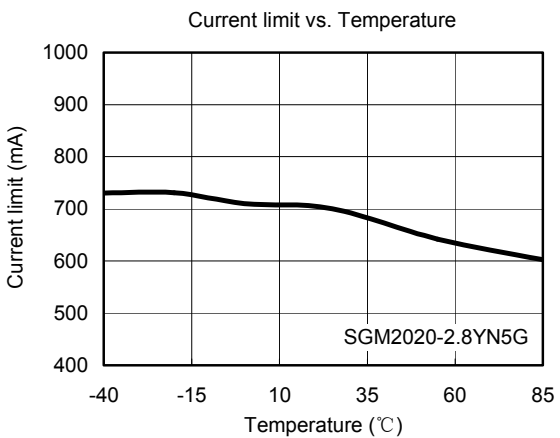
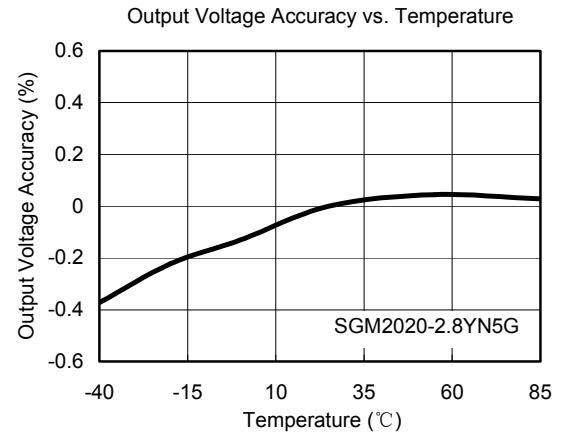
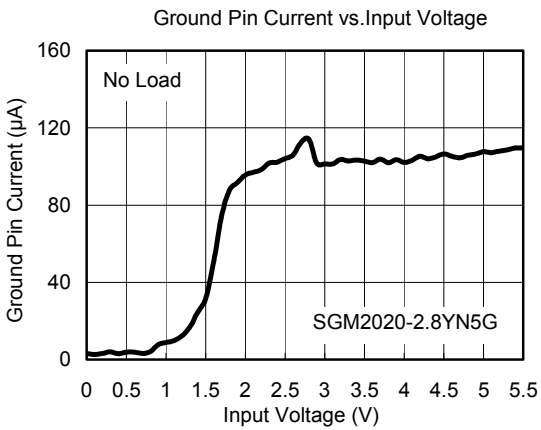
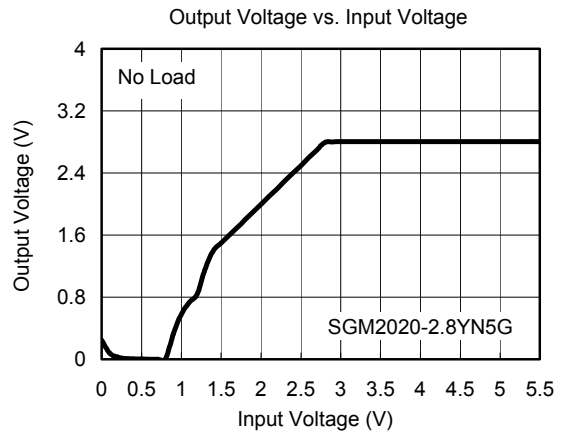
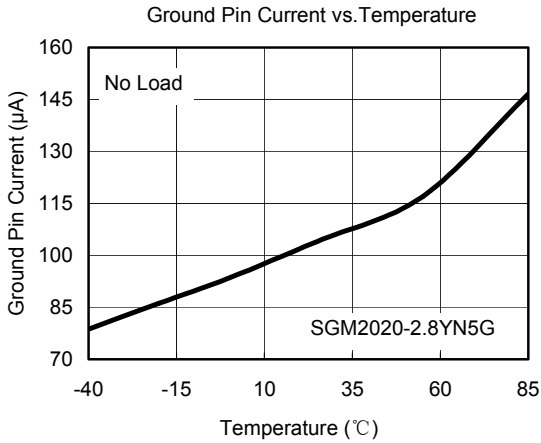

APPLICATION NOTE

When LDO is used in handheld products, attention must be paid to voltage spikes which could damage SGM2020. In such applications, voltage spikes will be generated at charger interface and V_{BUS} pin of USB interface when charger adapters and USB equipments are hot-plugged. Besides this, handheld products will be tested on the production line without battery. Test engineer will apply power from the connector pin which connects with positive pole of the battery. When external power supply is turned on suddenly, the voltage spikes will be generated at the battery connector. The voltage spikes will be very high, and it always exceeds the absolute maximum input voltage (6.0V) of LDO. In order to get robust design, design engineer needs to clear up this voltage spike. Zener diode is a cheap and effective solution to eliminate such voltage spike. For example, BZM55B5V6 is a 5.6V small package Zener diode which can be used to remove voltage spikes in cell phone designs. The schematic is shown below.

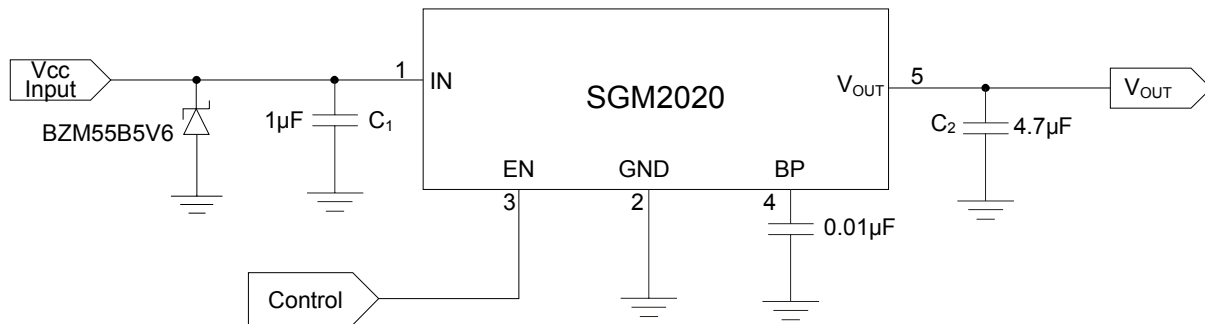

EXPANDED ORDERING INFORMATION

MODEL	V _{OUT} (V)	PIN-PACKAGE	ORDERING NUMBER	PACKAGE MARKING	PACKAGE OPTION
SGM2020-1.2	1.2V	SOT-23-5	SGM2020-1.2YN5G/TR	YK12	Tape and Reel, 3000
SGM2020-1.5	1.5V	SOT-23-5	SGM2020-1.5YN5G/TR	YK15	Tape and Reel, 3000
SGM2020-1.8	1.8V	SOT-23-5	SGM2020-1.8YN5G/TR	YK18	Tape and Reel, 3000
SGM2020-1.8	1.8V	SC70-5	SGM2020-1.8YC5G/TR	YK18	Tape and Reel, 3000
SGM2020-2.5	2.5V	SOT-23-5	SGM2020-2.5YN5G/TR	YK25	Tape and Reel, 3000
SGM2020-2.8	2.8V	SOT-23-5	SGM2020-2.8YN5G/TR	YK28	Tape and Reel, 3000
SGM2020-2.8	2.8V	SC70-5	SGM2020-2.8YC5G/TR	YK28	Tape and Reel, 3000
SGM2020-2.85	2.85V	SOT-23-5	SGM2020-2.85YN5G/TR	YK2J	Tape and Reel, 3000
SGM2020-3.0	3.0V	SOT-23-5	SGM2020-3.0YN5G/TR	YK30	Tape and Reel, 3000
SGM2020-3.3	3.3V	SOT-23-5	SGM2020-3.3YN5G/TR	YK33	Tape and Reel, 3000

PACKAGE OUTLINE DIMENSIONS

SOT-23-5

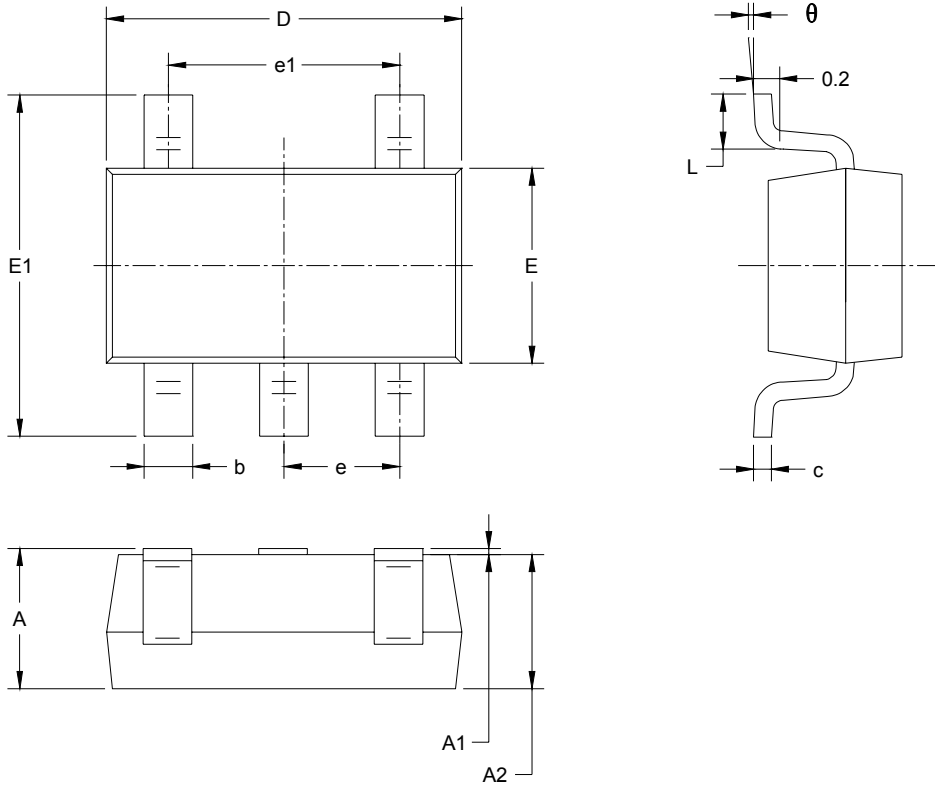

Symbol	Dimensions In Millimeters		Dimensions In Inches	
	Min	Max	Min	Max
A	1.050	1.250	0.041	0.049
A1	0.000	0.100	0.000	0.004
A2	1.050	1.150	0.041	0.045
b	0.300	0.500	0.012	0.020
c	0.100	0.200	0.004	0.008
D	2.820	3.020	0.111	0.119
E	1.500	1.700	0.059	0.067
E1	2.650	2.950	0.104	0.116
e	0.950 BSC		0.037 BSC	
e1	1.900 BSC		0.075 BSC	
L	0.300	0.600	0.012	0.024
theta	0°	8°	0°	8°

PACKAGE OUTLINE DIMENSIONS

SC70-5

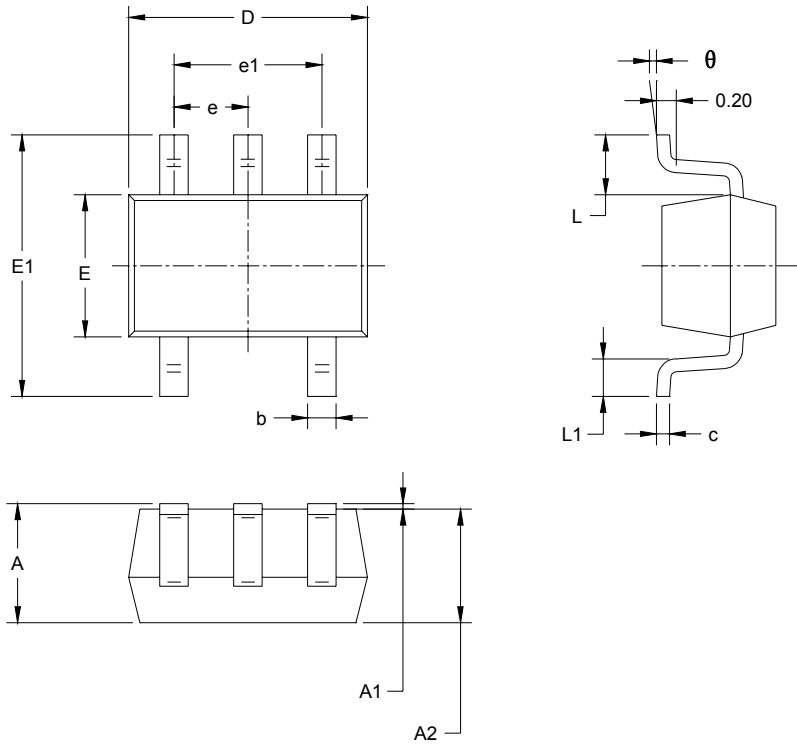

Symbol	Dimensions In Millimeters		Dimensions In Inches	
	Min	Max	Min	Max
A	0.900	1.100	0.035	0.043
A1	0.000	0.100	0.000	0.004
A2	0.900	1.000	0.035	0.039
b	0.150	0.350	0.006	0.014
c	0.080	0.150	0.003	0.006
D	2.000	2.200	0.079	0.087
E	1.150	1.350	0.045	0.053
E1	2.150	2.450	0.085	0.096
e	0.65 TYP		0.026 TYP	
e1	1.300 BSC		0.051 BSC	
L	0.525 REF		0.021 REF	
L1	0.260	0.460	0.010	0.018
θ	0°	8°	0°	8°