

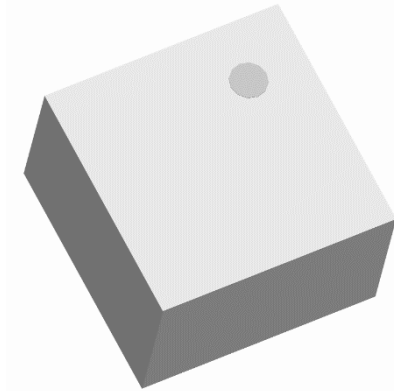

**Ultra Low Profile 0404 Balun
50Ω to 150Ω Balanced**

Description:

The BD4859N50150AHF is a low cost, low profile sub-miniature unbalanced to balanced transformer designed for differential inputs and output locations on modern chipsets in an easy to use surface mount package covering 802.11a Uni-Band II & III and the Japanese ISM band (4.9 GHz). The BD4859N50150AHF is ideal for high volume manufacturing and delivers higher performance than traditional ceramic baluns. The BD4859N50150AHF has an unbalanced port impedance of 50Ω and a 150Ω balanced port impedance. This transformation enables single ended signals to be applied to differential ports on modern integrated chipsets. The output ports have equal amplitude (-3dB) with 180 degree phase differential. The BD4859N50150AHF is available on tape and reel for pick and place high volume manufacturing.



Detailed Electrical Specifications:

Specifications subject to change without notice.

Features:	Parameter	ROOM (25°C)			Unit
		Min.	Typ.	Max	
• 4800 – 5900 MHz	Frequency	4800		5900	MHz
• 0.56 mm Height Profile	Unbalanced Port Impedance		50		Ω
• 50 Ohm to 2 x 75 Ohm	Balanced Port Impedance		150		Ω
• Low Insertion Loss	Return Loss	12	17		dB
• 802.11a Uni-Band II & III	Insertion Loss*		0.4	0.6	dB
• Home Cordless Compliant	Amplitude Balance		0.8	1.4	dB
• Surface Mountable	Phase Balance		4	10	Degrees
• Tape & Reel	CMRR		26		dB
• Non-conductive Surface	Power Handling			1.0	Watts
• RoHS Compliant	Operating Temperature	-55		+85	°C
• Halogen Free					

* Insertion Loss stated at room temperature (Insertion Loss is approximately 0.1 dB higher at +85 °C)

Outline Drawing:

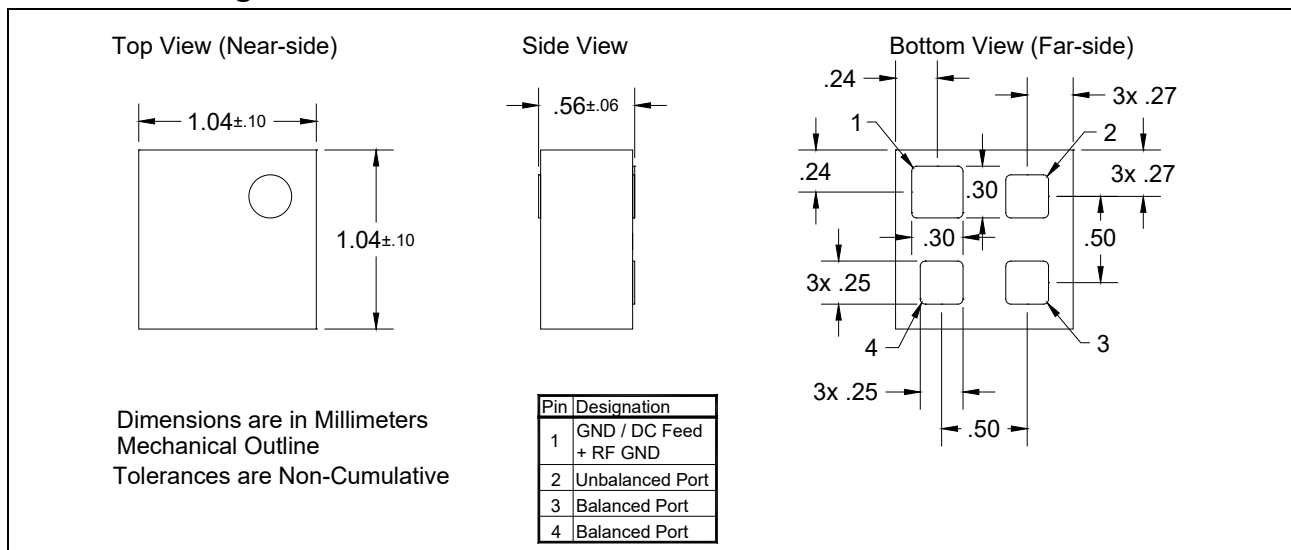

Typical Performance: 4700 MHz. to 6000 MHz.

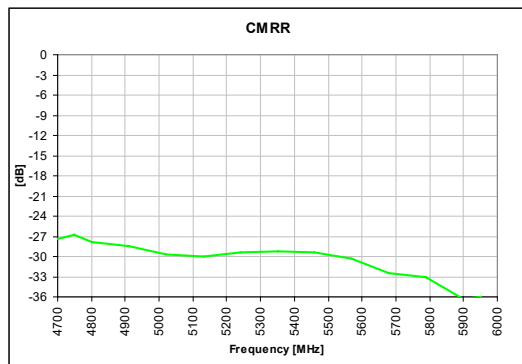
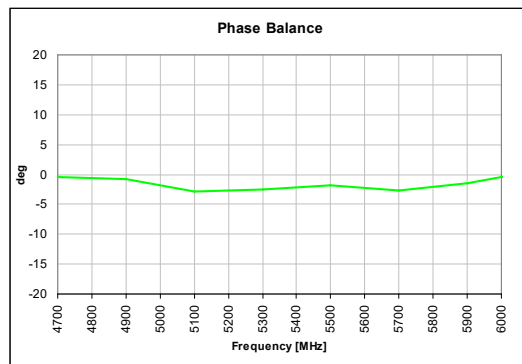
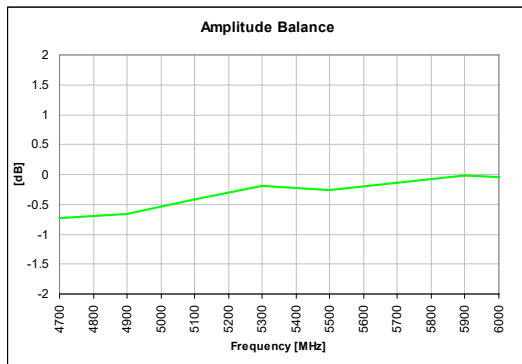
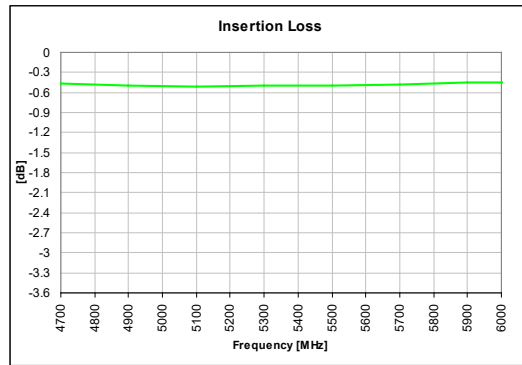
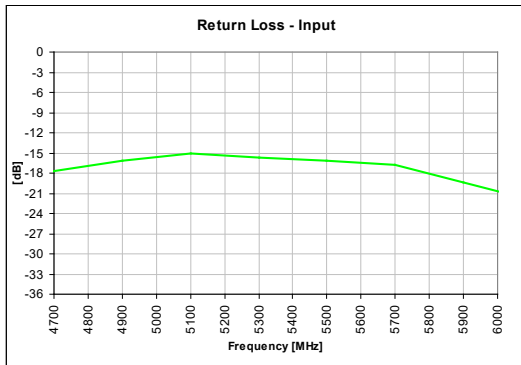

Wide Band Performance: 500 MHz. to 8500 MHz.

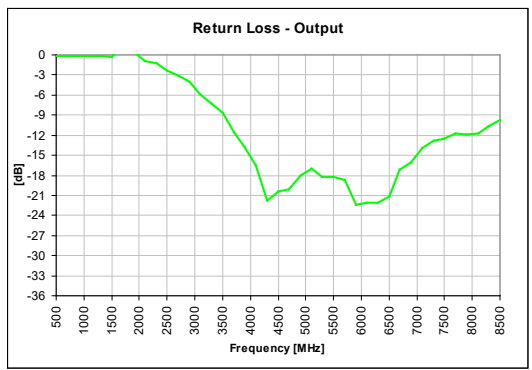
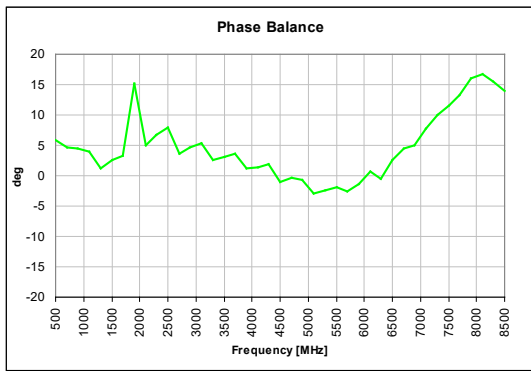
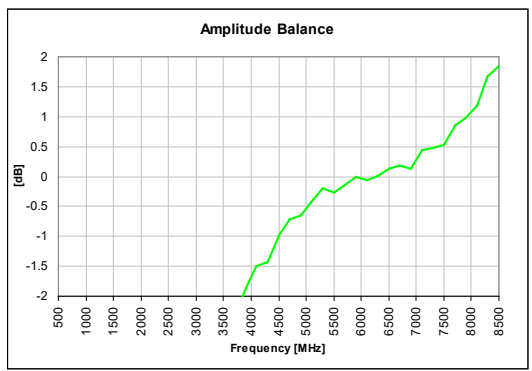
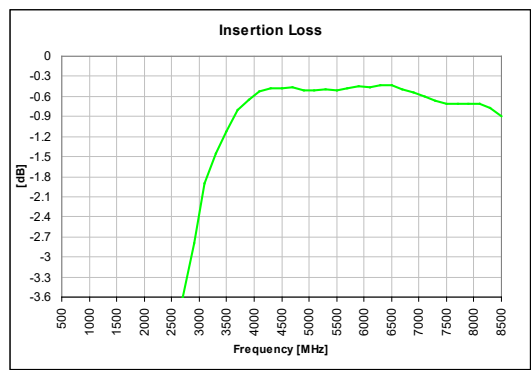
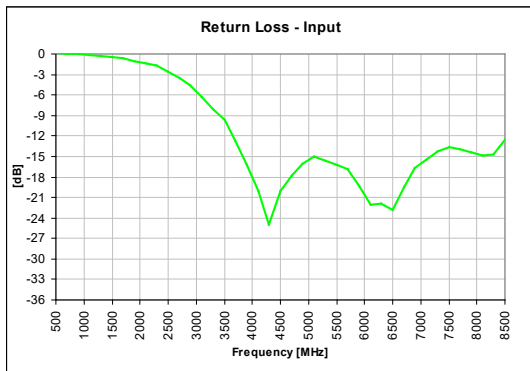

Mounting Configuration:

In order for Xinger surface mount components to work optimally, the proper impedance transmission lines must be used to connect to the RF ports. If this condition is not satisfied, insertion loss, Isolation and VSWR may not meet published specifications.

All of the Xinger components are constructed from ceramic filled PTFE composites which possess excellent electrical and mechanical stability.

An example of the PCB footprint used in the testing of these parts is shown below. An example of a DC-biased footprint is also shown below. In specific designs, the transmission line widths need to be adjusted to the unique dielectric coefficients and thicknesses as well as varying pick and place equipment tolerances

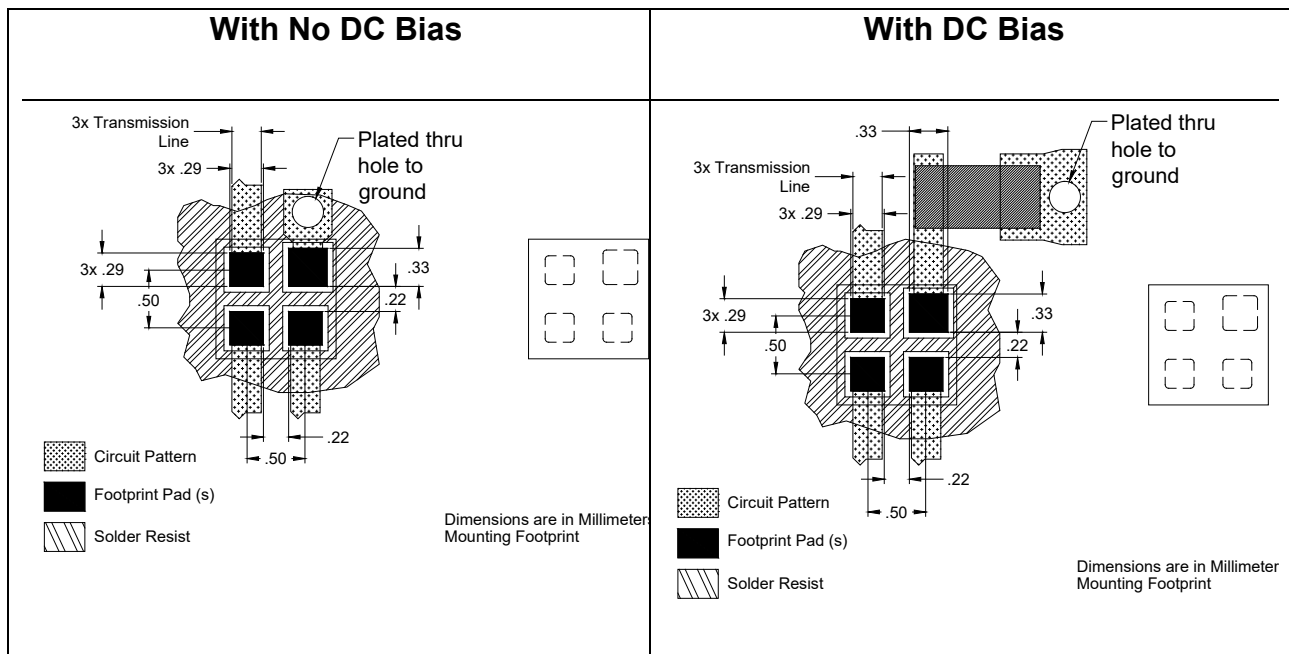

Packaging and Ordering Information:

Parts are available in reel and are packaged per EIA 481-2. Parts are oriented in tape and reel as shown below. Minimum order quantities are 4000 per reel. See Model Numbers below for further ordering information.

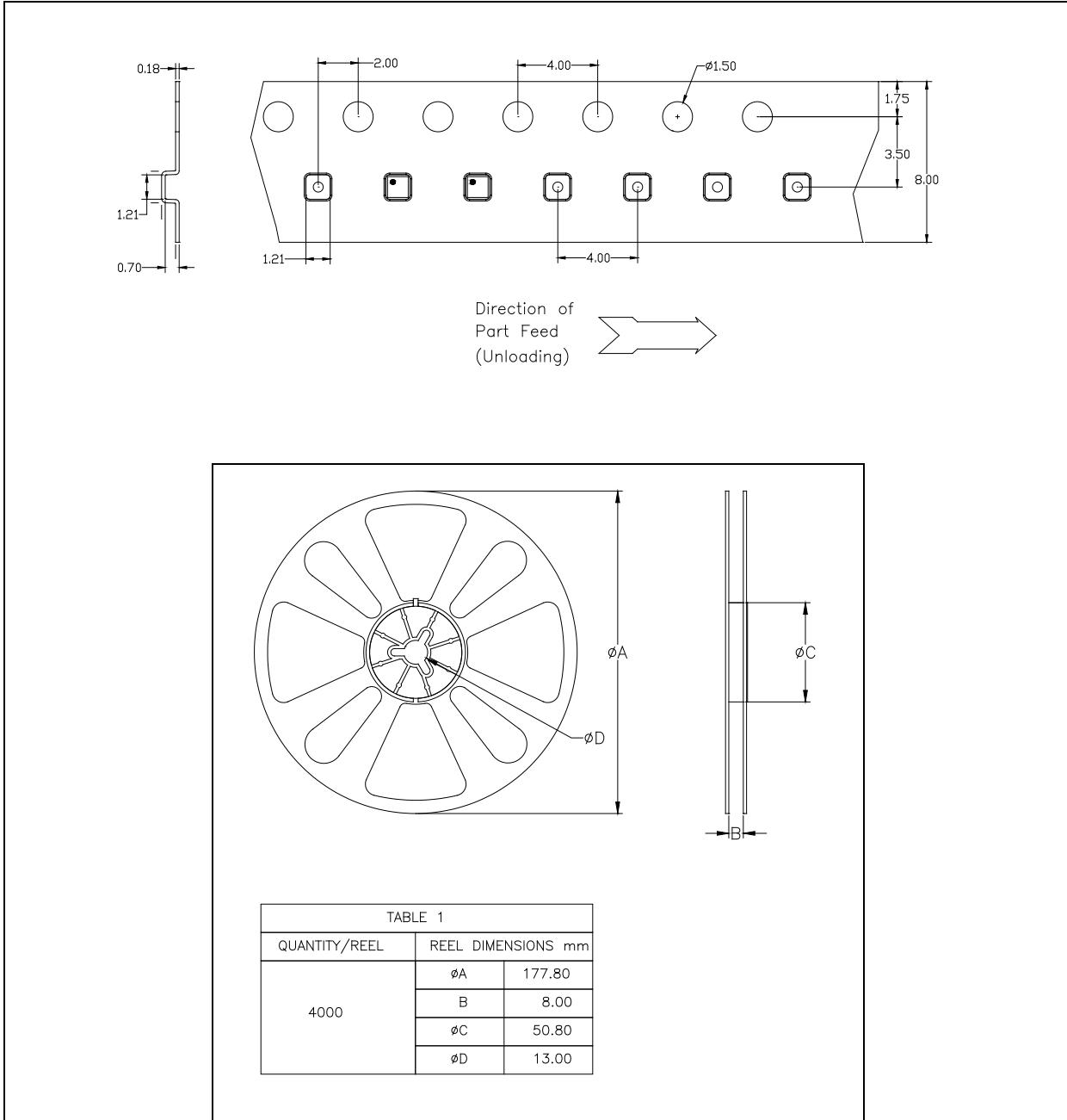

Contact us:
rf&s_support@ttm.com