

◆ MAJOR USES

- Output choke coils for Switching Mode Power Supply
- Choke coils for DC-DC converter
- Normal mode choke coils for noise control

◆ FEATURES

- Great reduction of core loss enabling low temperature rise at high frequency
- Miniaturization and reduction of DC resistance
- Low leakage flux due to gap-less structure
- Excellent frequency and temperature features

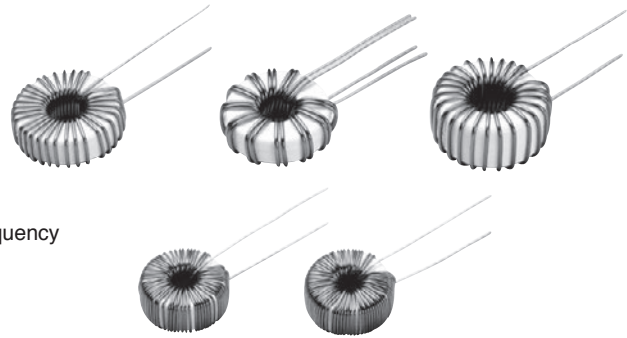

◆ CORE STANDARD SPECIFICATIONS

Core Part No. (Old Core Part No.)	Abbreviation	Cross Sectional Area cm ²	Magnetic Path Length cm	Outside Dimensions			Inductance Coefficient AL Value		
				Outer Diameter mm	Width mm	Height mm	I _{dc} =0[A] μH	Rated Current* μH	Rated Current Ampere Turn [AT]
LPT100805N (T100805N)	NS	0.08	2.84	13.0	6.0	6.5	0.100	0.063	70
LPT130805N (T130805N)	N1	0.13	3.44	16.0	5.8	7.4	0.120	0.070	75
LPT150905N (T150905N)	N2	0.14	3.85	17.2	7.3	6.4	0.118	0.063	100
LPT211205N (T211205N)	N5	0.21	5.26	23.2	10.2	6.9	0.126	0.060	155
LPT160910N (T160910N)	NU	0.29	3.92	18.0	7.3	11.9	0.260	0.115	120
LPT191210N (T191210N)	NP	0.33	4.95	21.9	9.8	11.8	0.212	0.095	160
LPT221310N (T221310N)	N6	0.40	5.50	24.7	10.5	12.0	0.229	0.112	160
LPT251510N (T251510N)	N7	0.53	6.60	29.7	12.5	12.3	0.253	0.120	200
LPT322010N (T322010N)	N9	0.56	8.25	35.2	17.5	12.3	0.211	0.090	280

*200[kHz], ±25% (LPT100805N : 100[kHz], ±25%)

◆ CORE LOSS CHARACTERISTICS

- TM choke

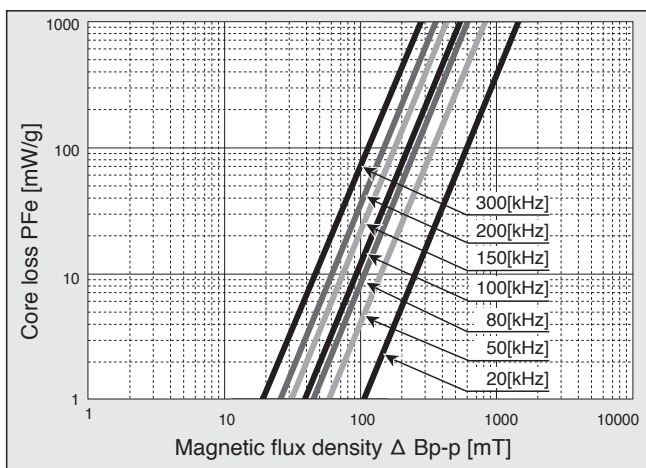

◆FREQUENCY - INDUCTANCE CHARACTERISTICS

●TM choke

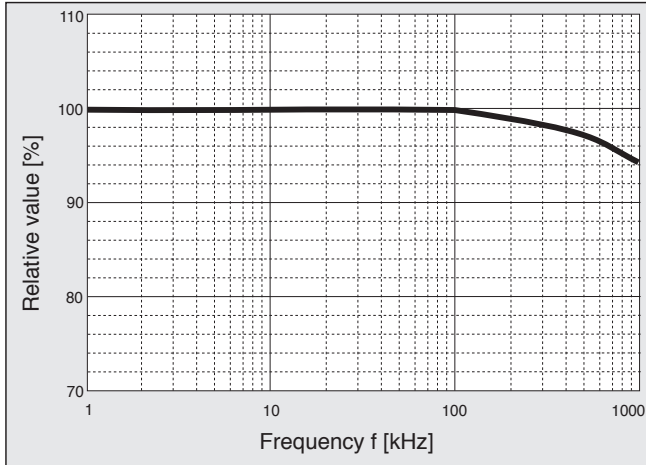

◆TEMPERATURE DEPENDENCE
- INDUCTANCE AND CORE LOSS

●Frequency : 200[kHz]

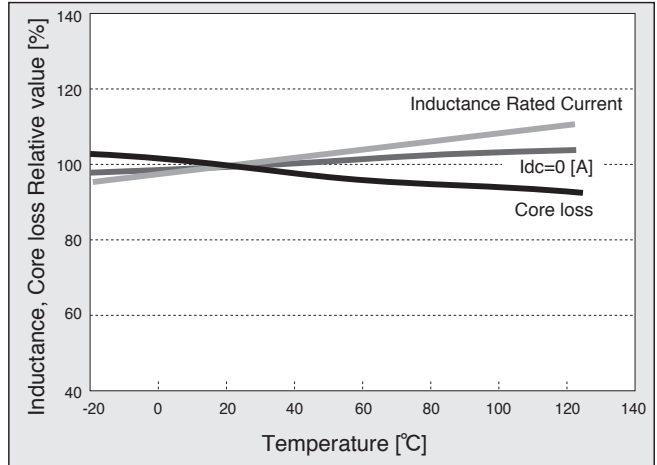

◆B-H CURVE

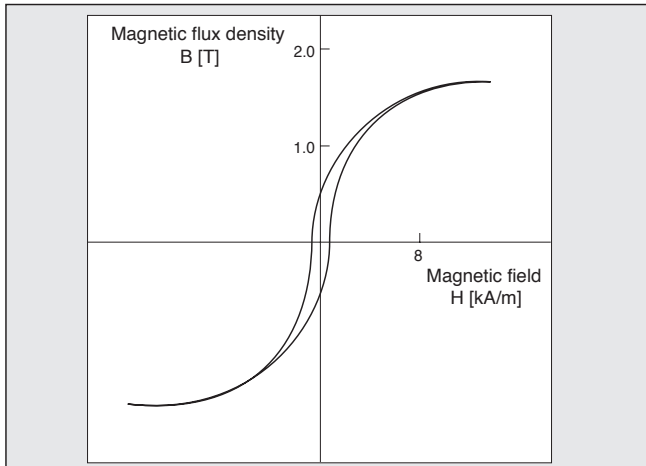

◆D.C. BIAS CHARACTERISTICS AL-AT(1)

●Frequency : 200[kHz] (LPT100805N : 100[kHz])

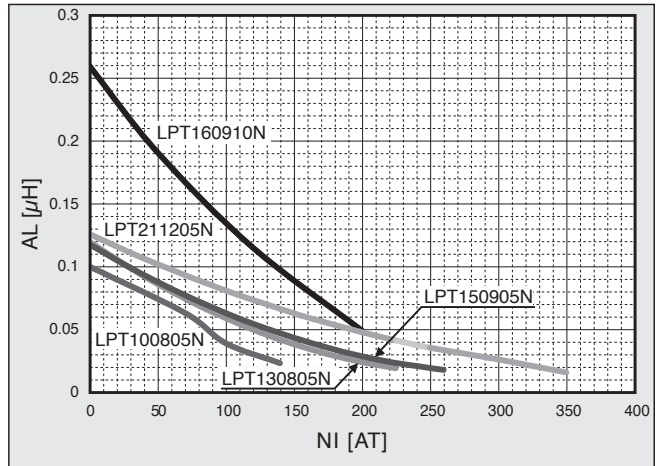

◆D.C. BIAS CHARACTERISTICS AL-AT(2)

●Frequency : 200[kHz]

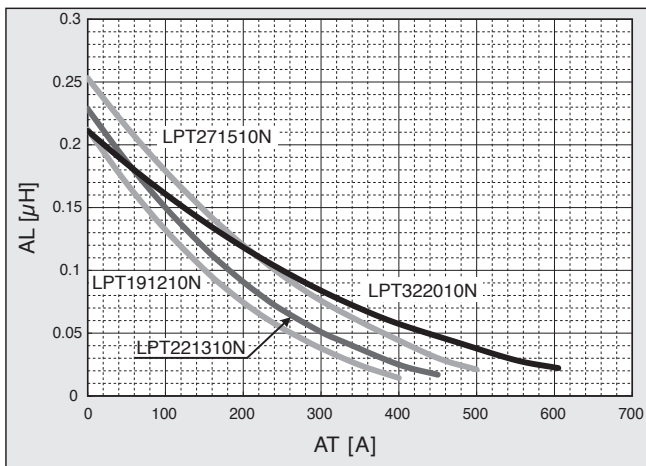

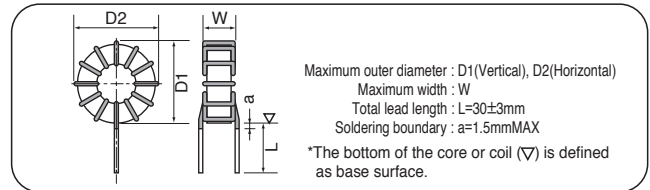

◆COIL STANDARD SPECIFICATIONS

Coil Part No. (Old Coil Part No.)	Rated Current A	Inductance ^{*1} (200kHz) ^{*2}		D.C.R. mΩ (max)	Winding mmφ×lines	Outside Dimensions		
		0[A] μH	Rating μH			D1 mm	D2 mm	W mm
● LBTM001201NS-V0E (TM01201NSPBF)	1	260 ^{*2}	200 ^{*2}	120	0.5×1P	16.0	16.0	11.0
● LBTM002800NS-V0E (TM02800NSPBF)	2	120 ^{*2}	80 ^{*2}	60	0.6×1P	16.5	16.5	11.0
● LBTM003270NS-V0E (TM03270NSPBF)	3	40 ^{*2}	27 ^{*2}	20	0.8×1P	16.5	17.0	11.5
● LBTM005100NS-V0E (TM05100NSPBF)	5	14 ^{*2}	10 ^{*2}	9	1.0×1P	17.0	17.5	11.5
● LBTM001201N1-V0E (TM01201N1PBF)	1	290	200	150	0.5×1P	18.5	19.0	10.5
● LBTM001251N1-V0E (TM01251N1PBF)	1	400	250	170	0.5×1P	18.5	19.0	11.0
● LBTM001301N1-V0E (TM01301N1PBF)	1	430	300	170	0.5×1P	19.5	19.5	11.5
● LBTM002101N1-V0E (TM02101N1PBF)	2	160	100	70	0.6×1P	19.5	19.5	11.5
● LBTM003400N1-V0E (TM03400N1PBF)	3	69	40	27	0.8×1P	19.5	19.5	11.5
● LBTM004250N1-V0E (TM04250N1PBF)	4	43	25	18	0.9×1P	19.5	19.5	11.5
● LBTM005150N1-V0E (TM05150N1PBF)	5	23	15	11	1.0×1P	19.5	20.0	11.5
● LBTM001401N2-V0E (TM01401N2PBF)	1	580	400	210	0.5×1P	19.5	20.0	11.0
● LBTM001501N2-V0E (TM01501N2PBF)	1	770	500	230	0.5×1P	20.0	20.5	11.0
● LBTM002151N2-V0E (TM02151N2PBF)	2	240	150	89	0.6×1P	20.0	20.5	10.5
● LBTM002201N2-V0E (TM02201N2PBF)	2	360	200	110	0.6×1P	20.0	20.5	11.0
● LBTM002211N2-V0E (TM02211N2PBF)	2	400	210	110	0.6×1P	20.5	21.0	11.5
● LBTM003700N2-V0E (TM03700N2PBF)	3	110	70	36	0.8×1P	20.5	21.0	11.5
● LBTM004450N2-V0E (TM04450N2PBF)	4	74	45	24	0.9×1P	21.0	21.5	11.5
● LBTM004500N2-V0E (TM04500N2PBF)	4	92	50	24	0.9×1P	21.0	21.5	11.5
● LBTM005300N2-V0E (TM05300N2PBF)	5	52	30	17	1.0×1P	21.0	21.5	12.0
● LBTM006200N2-V0E (TM06200N2PBF)	6	34	20	11	0.8×2P	21.0	21.5	12.0

*1 Rated inductance tolerance : ±25%, the inductance at current 0[A] indicates the reference value.

*2 LBTM001201NS-V0E, LBTM002800NS-V0E, LBTM003270NS-V0E, LBTM005100NS-V0E, LBTM001132N5-V0E : 100kHz

There is a horizontal putting type in all items in the above list."V" changes into "H" in last the third digit of the name of items.

There is a type with the length putting seat in ● item in the above list."V" changes into "D" in last the third digit of the name of items.

There are the type with the length putting seat and the horizontal putting seat in ◎ item.

The type with the length putting seat is "V" changes into "B" in last the third digit of the name of items.

*Order the auxiliary pins separately if they are required for the pedestal.

Please select them according to the situation.

◆ COIL STANDARD SPECIFICATIONS

Coil Part No. (Old Coil Part No.)	Rated Current A	Inductance ¹ (200kHz) ²		D.C.R. mΩ (max)	Winding mmφ×lines	Outside Dimensions		
		0[A] μH	Rating μH			D1 mm	D2 mm	W mm
● LBTM001132N5-V0E (TM01132N5PBF)	1	2000 ²	1300 ²	400	0.5×1P	26.0	27.0	12.0
● LBTM003800N5-V0E (TM03800N5PBF)	3	120	80	41	0.8×1P	26.5	27.5	11.0
● LBTM003171N5-V0E (TM03171N5PBF)	3	290	170	59	0.8×1P	26.5	27.5	12.0
● LBTM005750N5-V0E (TM05750N5PBF)	5	150	75	27	1.0×1P	27.0	28.0	13.5
● LBTM006450N5-V0E (TM06450N5PBF)	6	85	45	18	0.8×2P	27.0	28.0	13.0
● LBTM008250N5-V0E (TM08250N5PBF)	8	45	25	11	0.9×2P	27.0	28.0	13.5
● LBTM010160N5-V0E (TM10160N5PBF)	10	28	16	7	1.1×2P	28.0	29.0	14.0
● LBTM015080N5-V0E (TM15080N5PBF)	15	15	8	4	1.1×3P	28.5	29.5	14.5
● LBTM002351NU-V0E (TM02351NUPBF)	2	700	350	135	0.6×1P	22.0	22.0	16.5
● LBTM003131NU-V0E (TM03131NUPBF)	3	230	130	44	0.8×1P	22.5	22.5	17.0
● LBTM005500NU-V0E (TM05500NUPBF)	5	94	50	19	1.0×1P	22.5	22.5	16.5
● LBTM008170NU-V0E (TM08170NUPBF)	8	31	17	7	0.9×2P	22.5	22.5	16.5
● LBTM002621NP-V0E (TM02621NPPBF)	2	1200	620	150	0.7×1P	25.0	25.5	16.5
● LBTM003291NP-V0E (TM03291NPPBF)	3	550	290	76	0.8×1P	25.0	25.5	16.0
● LBTM004161NP-V0E (TM04161NPPBF)	4	320	160	46	0.9×1P	25.0	25.0	16.5
● LBTM005101NP-V0E (TM05101NPPBF)	5	190	100	29	1.0×1P	25.5	26.0	16.5
● LBTM006700NP-V0E (TM06700NPPBF)	6	130	70	19	0.8×2P	25.0	25.5	16.0
● LBTM008400NP-V0E (TM08400NPPBF)	8	77	40	12	0.9×2P	25.0	25.0	16.5
● LBTM010270NP-V0E (TM10270NPPBF)	10	54	27	7	1.1×2P	26.0	26.0	17.0
● LBTM015120NP-V0E (TM15120NPPBF)	15	26	12	4	1.1×3P	26.0	26.0	17.5

◆ COIL STANDARD SPECIFICATIONS

Coil Part No. (Old Coil Part No.)	Rated Current A	Inductance ^{*1} (200kHz) ^{*2}		D.C.R. mΩ (max)	Winding mmφ×lines	Outside Dimensions		
		0[A] μH	Rating μH			D1 mm	D2 mm	W mm
LBTM002701N6-V0E (TM02701N6PBF)	2	1200	700	150	0.7×1P	27.5	28.0	16.5
LBTM003181N6-V0E (TM03181N6PBF)	3	260	180	50	0.8×1P	27.5	28.0	15.0
LBTM003351N6-V0E (TM03351N6PBF)	3	640	350	82	0.8×1P	27.5	28.0	16.5
LBTM004101N6-V0E (TM04101N6PBF)	4	140	100	33	0.9×1P	27.5	28.0	16.0
LBTM004201N6-V0E (TM04201N6PBF)	4	370	200	48	0.9×1P	28.0	28.5	16.5
LBTM005131N6-V0E (TM05131N6PBF)	5	250	130	34	1.0×1P	28.5	29.0	17.0
LBTM006850N6-V0E (TM06850N6PBF)	6	170	85	22	0.8×2P	28.0	28.5	17.0
LBTM008450N6-V0E (TM08450N6PBF)	8	83	45	13	0.9×2P	28.0	28.5	17.0
LBTM010300N6-V0E (TM10300N6PBF)	10	51	30	7	1.1×2P	29.0	29.5	17.5
LBTM015160N6-V0E (TM15160N6PBF)	15	33	16	5	1.1×3P	28.5	29.0	18.5
LBTM020100N6-V0E (TM20100N6PBF)	20	23	10	4	1.3×3P	29.5	30.0	19.0
LBTM002901N7-V0E (TM02901N7PBF)	2	1500	900	240	0.6×1P	32.0	32.5	15.5
LBTM002112N7-V0E (TM02112N7PBF)	2	1800	1100	190	0.7×1P	32.5	33.0	16.5
LBTM003481N7-V0E (TM03481N7PBF)	3	820	480	94	0.8×1P	32.5	33.0	16.5
LBTM005141N7-V0E (TM05141N7PBF)	5	240	140	34	1.0×1P	33.0	33.5	16.0
LBTM005211N7-V0E (TM05211N7PBF)	5	390	210	42	1.0×1P	33.0	33.5	17.5
LBTM010300N7-V0E (TM10300N7PBF)	10	45	30	7	1.6×1P	35.5	36.0	18.5
LBTM010500N7-V0E (TM10500N7PBF)	10	100	50	11	1.1×2P	34.0	34.5	18.0
LBTM015260N7-V0E (TM15260N7PBF)	15	65	26	6	1.1×3P	33.5	34.0	18.0
LBTM025100N7-V0E (TM25100N7PBF)	25	25	10	3	1.6×2P	35.5	36.0	19.0
LBTM003501N9-V0E (TM03501N9PBF)	3	840	500	120	0.8×1P	38.5	39.0	18.5
LBTM005281N9-V0E (TM05281N9PBF)	5	530	280	61	1.0×1P	39.5	40.0	19.0
LBTM005301N9-V0E (TM05301N9PBF)	5	550	300	62	1.0×1P	39.5	40.0	19.0
LBTM010600N9-V0E (TM10600N9PBF)	10	110	60	12	1.6×1P	41.5	42.0	20.0
LBTM010800N9-V0E (TM10800N9PBF)	10	170	80	15	1.1×2P	41.0	41.5	20.5
LBTM015400N9-V0E (TM15400N9PBF)	15	93	40	8	1.1×3P	39.5	40.0	20.0
LBTM020130N9-V0E (TM20130N9PBF)	20	21	13	4	1.3×3P	41.0	41.5	19.5
LBTM020200N9-V0E (TM20200N9PBF)	20	41	20	5	1.3×3P	40.5	41.0	20.5

◆ D.C. BIAS CHARACTERISTICS (1)

- Core : LPT100805N, Frequency : 100[kHz]
- Core : LPT130805N, Frequency : 200[kHz]

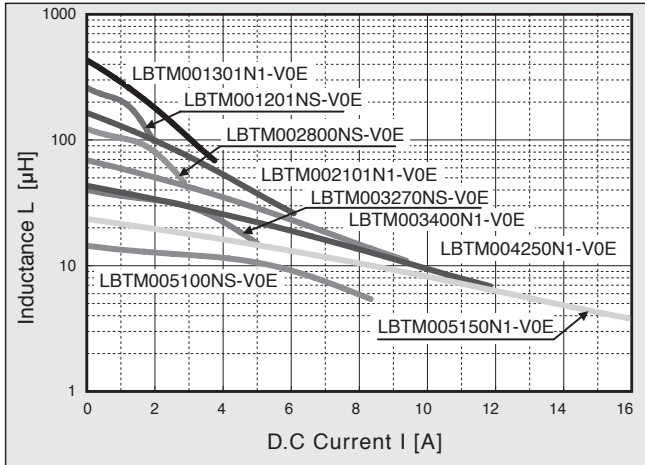

◆ D.C. BIAS CHARACTERISTICS (2)

- Core : LPT150905N, Frequency : 200[kHz]

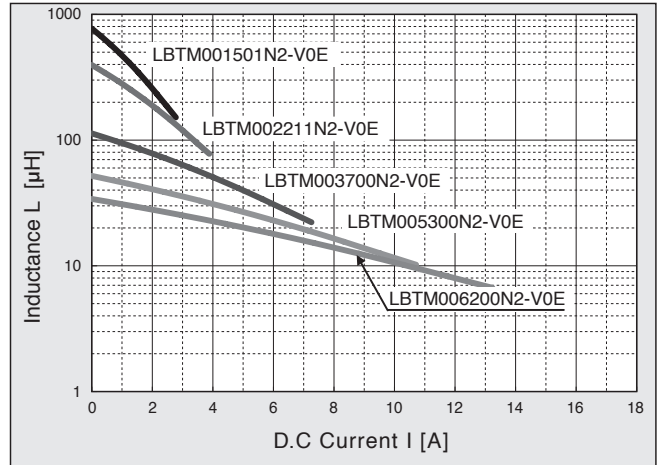

◆ D.C. BIAS CHARACTERISTICS (3)

- Core : LPT211205N, Frequency : 200[kHz]

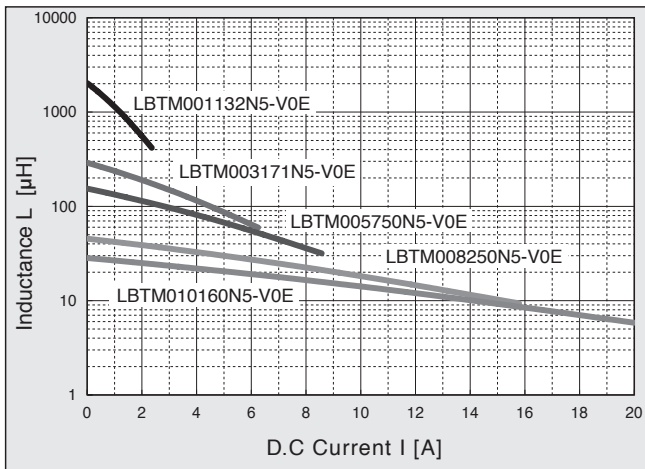

◆ D.C. BIAS CHARACTERISTICS (4)

- Core : LPT160910N, LPT191210N, Frequency : 200[kHz]

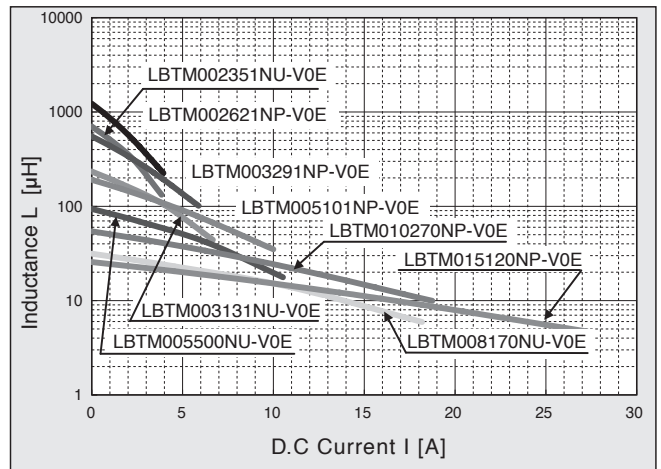

◆ D.C. BIAS CHARACTERISTICS (5)

- Core : LPT221310N, Frequency : 200[kHz]

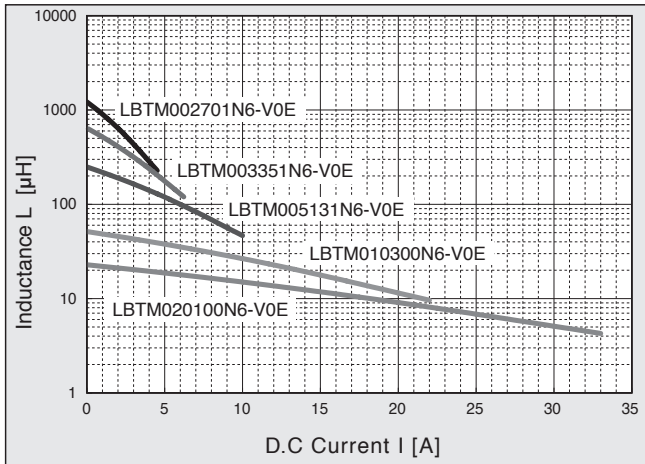

◆ D.C. BIAS CHARACTERISTICS (6)

- Core : LPT271510N, Frequency : 200[kHz]

