

National Semiconductor is now part of
Texas Instruments.

Search <http://www.ti.com/> for the latest technical
information and details on our current products and services.

LM9070

Low-Dropout System Voltage Regulator with Keep-Alive ON/OFF Control

General Description

The LM9070 is a 5V, 3% accurate, 250 mA low-dropout voltage regulator. The regulator features an active low delayed reset output flag which can be used to reset a micro-processor system on turn-ON and in the event that the regulator output falls out of regulation for any reason. An external capacitor programs a delay time interval before the reset output can return high.

Designed for automotive application the LM9070 contains a variety of protection features such as reverse battery, over-voltage shutdown, thermal shutdown, input transient protection and a wide operating temperature range.

A unique two-input logic control scheme is used to enable or disable the regulator output. An ON/OFF input can be provided by an ignition switch derived signal while a second, Keep-Alive input, is generated by a system controller. This allows for a system to remain ON after ignition has been switched OFF. The system controller can then execute a power-down routine and after which command the regulator OFF to a low quiescent current state (60 μ A max).

Design techniques have been employed to allow the regulator to remain operational and not generate false reset signals when subjected to high levels of RF energy (300V/m from 2 MHz to 400 MHz).

Features

- Automotive application reliability
- 3% output voltage tolerance
- Insensitive to radiated RFI
- Dropout voltage less than 800 mV with 250 mA output current
- Externally programmed reset delay interval
- Keep-alive feature with 2 logic control inputs
- 60V Load dump transient protection
- Thermal shutdown
- Short circuit protection and disable safety features
- Reverse battery protection
- Low OFF quiescent current, 50 μ A maximum
- Wide operating temperature range -40°C to $+125^{\circ}\text{C}$
- TO-263 and 20-pin power surface mount packages
- Lead form compatible with TLE4267 TO-220 regulator (package TA07D)

Connection Diagrams and Ordering Information (Top View)

**7-Lead TO-263
Surface Mount Package**

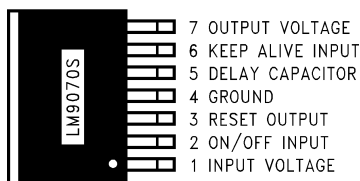

01283101

Backside metal is internally connected to ground.

**Order Number LM9070S
See NS Package Number TS7B**

20-Pin SO Package

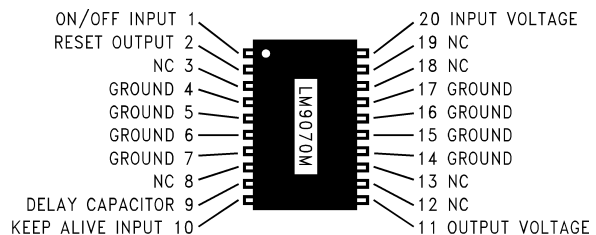

01283102

**Order Number LM9070M
See NS Package Number M20B**

Connection Diagrams and Ordering Information (Top View) (Continued)

7-Lead TO-220 Package
 (Odd numbered pins bent forward
 away from package
 body)

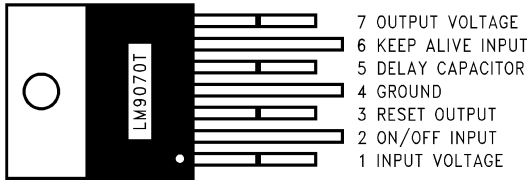

01283103

Tab is internally connected to ground.

Order Number LM9070T
See NS Package Number TA07B

7-Lead TO-220 Package
 (Even numbered pins bent forward
 away from package
 body)

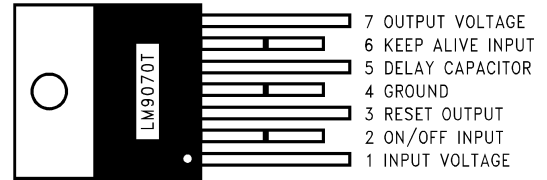

01283104

Tab is internally connected to ground.

Order Number LM9070T/Flow LB09
See NS Package Number TA07D

Absolute Maximum Ratings (Note 1)

Input Voltage, DC	-26V to +40V
ON/OFF, Keep-Alive Inputs (through 1k Ω)	-26V to +26V
Positive Input Transient (t<100 ms)	60V
Negative Input Transient (t<1 ms)	-50V
Reset Output Sink Current	5 mA
Power Dissipation	Internally Limited
Junction Temperature	150°C
ESD Susceptibility (Note 2)	12 kV, 2 kV
Lead Temperature (Soldering, 10 seconds)	260°C
Storage Temperature	-50°C to +150°C

Operating Ratings (Note 1)

Input Voltage	6V to 26V
Ambient Temperature	-40°C to +125°C
TO-220 Thermal Resistance, θ_{J-C}	3°C/W
TO-220 Thermal Resistance, θ_{J-A} (Note 3)	73°C/W
TO-263 Thermal Resistance, θ_{J-C}	3°C/W
TO-263 Thermal Resistance, θ_{J-A} (Note 4)	80°C/W
SO20 Thermal Resistance, θ_{J-PINS}	25°C/W
SO20 Thermal Resistance, θ_{J-A}	85°C/W

Electrical Characteristics (Note 5)

The following specifications apply for $V_{CC}=6V$ to 26V, $-40^{\circ}C \leq T_A \leq 125^{\circ}C$, unless otherwise specified. $C_{OUT}=47\mu F$ with an $ESR < 3\Omega$. $C_{IN}=1\mu F$.

Symbol	Parameter	Conditions	Min	Max	Units
REGULATOR OUTPUT					
V_{OUT}	Output Voltage	$5\text{ mA} \leq I_{OUT} \leq 250\text{ mA}$	4.85	5.15	V
ΔV_{OUT} Line	Line Regulation	$I_{OUT} = 5\text{ mA}$, $9V \leq V_{IN} \leq 16.5V$ $I_{OUT} = 5\text{ mA}$, $6V \leq V_{IN} \leq 26V$		25 50	mV mV
ΔV_{OUT} Load	Load Regulation	$V_{IN} = 14.4V$, $5\text{ mA} \leq I_{OUT} \leq 250\text{ mA}$		50	mV
I_q	Quiescent Current	$V_{ON/OFF} \leq V_{IN}$ $I_{OUT} = 5\text{ mA}$ $I_{OUT} = 250\text{ mA}$, $V_{IN} \geq 8V$ $I_{OUT} = 5\text{ mA}$, $V_{IN} = 5V$ $I_{OUT} = 250\text{ mA}$, $V_{IN} = 6V$		4 25 10 50	mA mA mA mA
I_{off}	OFF Quiescent Current	$V_{IN} \leq 16.5V$, Regulator OFF $-40^{\circ}C \leq T_J \leq 60^{\circ}C$ $60^{\circ}C \leq T_J \leq 135^{\circ}C$		20 60	μA μA
V_{do}	Dropout Voltage	$I_{OUT} = 5\text{ mA}$ $I_{OUT} = 250\text{ mA}$		300 800	mV mV
I_{sc}	Short Circuit Current	$R_L = 1\Omega$	0.4	1.5	A
PSRR	Ripple Rejection	$V_{IN} = (14V_{DC}) + 1V_{RMS} @ 120Hz$ $I_{OUT} = 50\text{ mA}$	60		dB
V_{othOFF}	Safety V_{OUT} Latch-OFF Threshold	In Keep-Alive mode $V_{ON/OFF} = 0V$, $V_{KA} = 0V$	4	4.5	V
OVthr	Overvoltage Shutdown Threshold		27		V
V_o Transient	V_{OUT} during Transients	V_{IN} Peak $\leq 60V$, $R_L = 100\Omega$, $\tau = 100\text{ ms}$		7	V
RESET OUTPUT					
V_{th}	Threshold Voltage	ΔV_{OUT} Required to Generate a Reset Output $4.85V \leq V_{OUT} \leq 5.15V$	-300	-500	mV
V_{low}	Reset Output Low Voltage	$I_{sink} = 1.6\text{ mA}$, $V_{OUT} > 3.2V$ $1.4V \leq V_{OUT} \leq 3.2V$		0.4 0.8	V V
V_{high}	Reset Output High Voltage		$0.9 V_{OUT}$	V_{OUT}	V
t_{DELAY}	Delay Time	$C_{DELAY} = 0.1\mu F$	7	31	ms
I_{DELAY}	Charging Current for C_{DELAY}		10	30	μA
R_{pu}	Internal Pull-up Resistance		12	80	k Ω

Electrical Characteristics (Note 5) (Continued)

The following specifications apply for $V_{CC} = 6V$ to $26V$, $-40^{\circ}C \leq T_A \leq 125^{\circ}C$, unless otherwise specified. $C_{OUT} = 47\mu F$ with an $ESR < 3\Omega$. $C_{IN} = 1\mu F$.

Symbol	Parameter	Conditions	Min	Max	Units
CONTROL LOGIC					
$V_{KA\text{low}}$	Low Input Threshold Voltage, Keep-Alive Input	$3.5V \leq V_{OUT} \leq 5.25V$	$0.3 V_{OUT}$	$0.5 V_{OUT}$	V
$V_{KA\text{high}}$	High Input Threshold Voltage, Keep-Alive Input	$3.5V \leq V_{OUT} \leq 5.25V$	$0.6 V_{OUT}$	$0.8 V_{OUT}$	V
$V_{ON/OFF\text{ low}}$	Low Input Voltage, ON/OFF Input	$R_{series} = 1\text{ k}\Omega$	-2	2	V
$V_{ON/OFF\text{ high}}$	High Input Voltage, ON/OFF Input	$R_{series} = 1\text{ k}\Omega$	4	26	V
$I_{ON/OFF}$	Input Current, ON/OFF Input	$V_{ON/OFF} \leq 4V$ $4V < V_{ON/OFF} < 7V$ $V_{ON/OFF} \geq 7V$		330 670 10	μA μA mA
$R_{pU_{KA}}$	Internal Pull-up Resistance, Keep-Alive Input	$0V \leq V_{IN} \leq 26V$	20	100	$\text{k}\Omega$
$R_{pd_{ON/OFF}}$	Internal Pull-down Resistance ON/OFF Input	$0V \leq V_{ON/OFF} \leq 26V$	50	210	$\text{k}\Omega$

Note 1: Absolute Maximum Ratings indicate limits beyond which damage to the device may occur. **Operating Ratings** indicate conditions for which the device is intended to be functional, but do not guarantee specific performance limits. For guaranteed specifications and conditions, see the **Electrical Characteristics**.

Note 2: All pins will survive an ESD impulse of $\pm 2000V$ using the human body model of 100 pF discharged through a $1.5\text{ k}\Omega$ resistor. In addition, input pins V_{IN} and the ON/OFF input will withstand ten pulses of $\pm 12\text{ kV}$ from a 150 pF capacitor discharged through a 560Ω resistor with each pin bypassed with a 22 nF , $100V$ capacitor.

Note 3: Exceeding the Maximum Allowable power dissipation will cause excessive die temperature, and the device will go into thermal shutdown. The θ_{JA} value for the TO-220 package (still air, no additional heat sink) is $73^{\circ}C/W$. The effective θ_{JA} value of the TO-220 package can be reduced by using conventional heat sink methods.

Note 4: Exceeding the Maximum Allowable power dissipation will cause excessive die temperature, and the device will go into thermal shutdown. The θ_{JA} value for the TO-263 package (still air, no additional heat sink) is $80^{\circ}C/W$. The effective θ_{JA} value of the TO-263 package can be reduced by increasing the printed circuit board area that is connected (soldered) to the package tab. Using 1 ounce (1.4 mils thick) copper clad with no solder mask, an area of 0.5 square inches will reduce θ_{JA} to $50^{\circ}C/W$, an area of 1.0 square inches will reduce θ_{JA} to $37^{\circ}C/W$, and an area of 1.6 square inches will reduce θ_{JA} to $32^{\circ}C/W$. If the printed circuit board uses a solder mask, the copper clad area should be increased by at least 50% to maintain a similar θ_{JA} rating.

Note 5: Datasheet min/max specifications are guaranteed by design, test, and/or statistical analysis.

Reset Operation and Protection Features

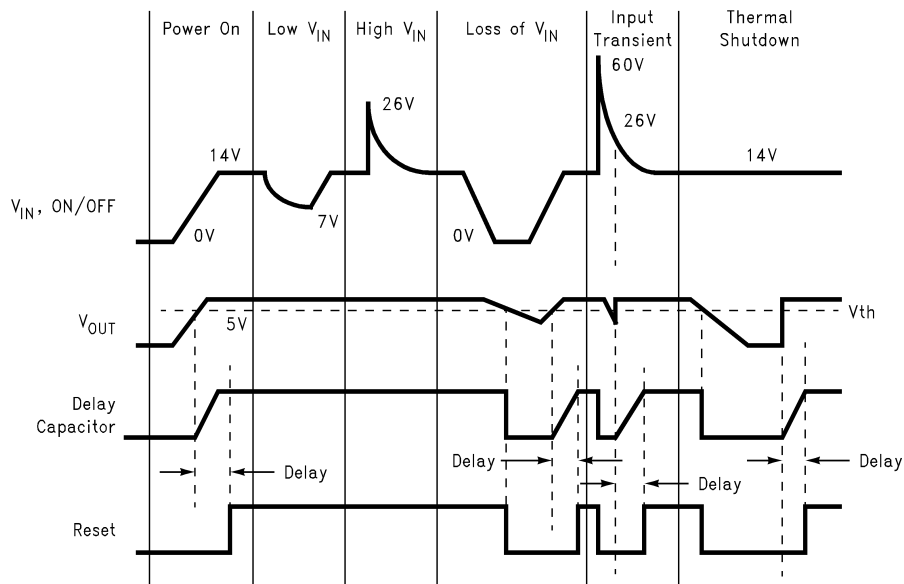

01283105

Typical Performance Characteristics

($T_A = 25^\circ\text{C}$ unless indicated otherwise)

Turn ON Characteristics

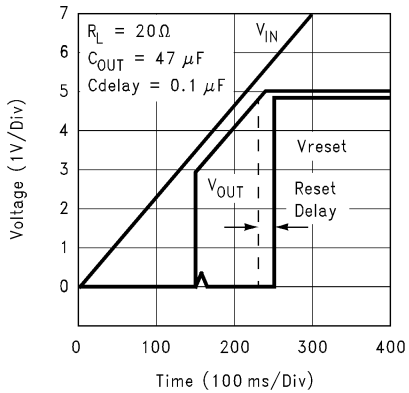

01283106

Turn OFF Characteristics

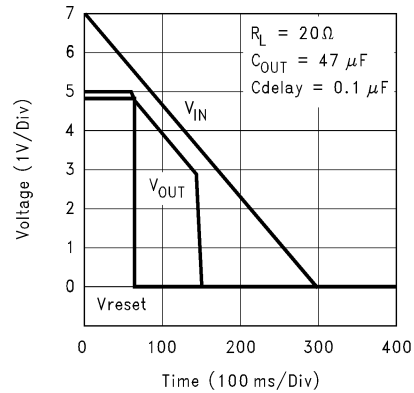

01283107

Normalized Output Voltage vs Temperature

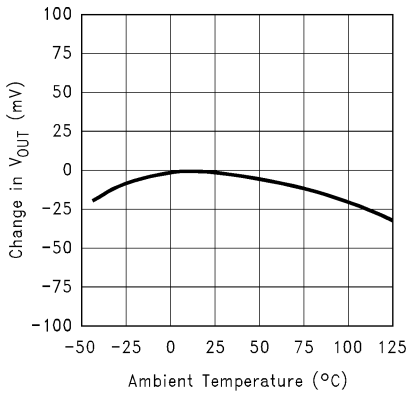

01283108

Output Voltage at Input Voltage Extremes

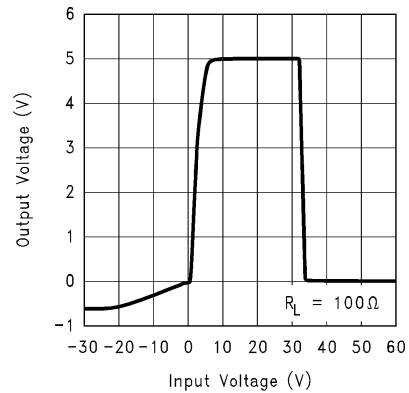

01283109

Quiescent Current vs Input Voltage

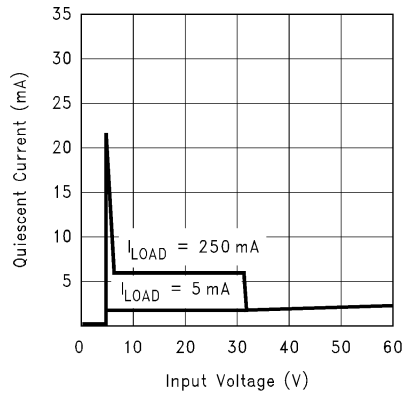

01283110

**Input Current vs Input Voltage
Regulator Switched OFF**

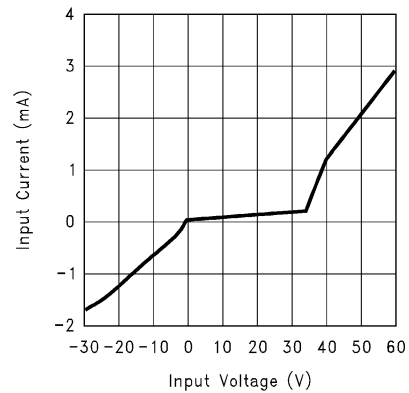

01283111

Typical Performance Characteristics ($T_A = 25^\circ\text{C}$ unless indicated otherwise) (Continued)

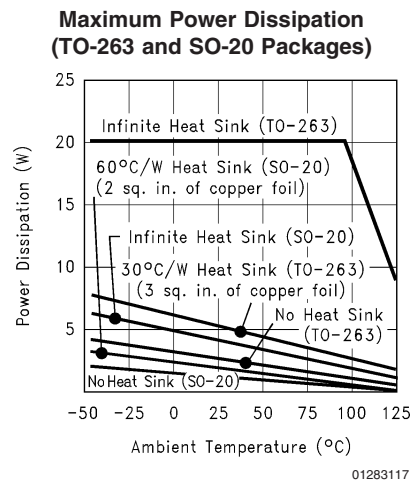
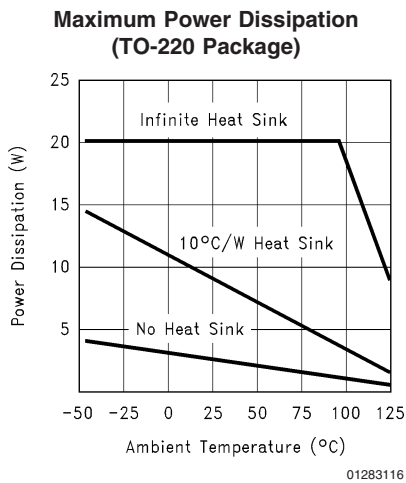
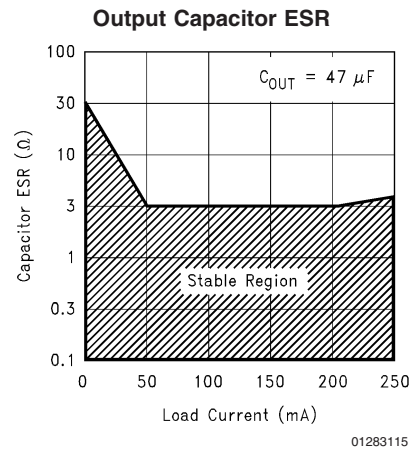
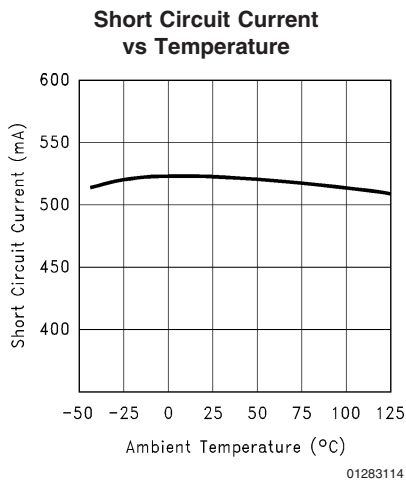
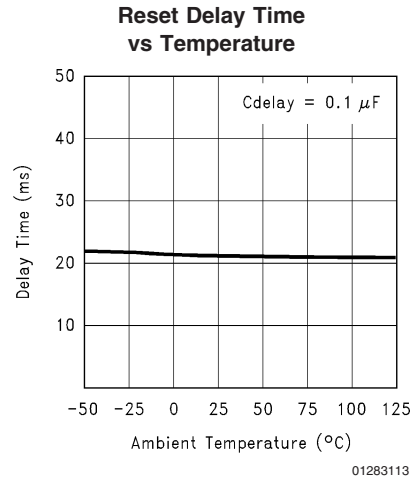
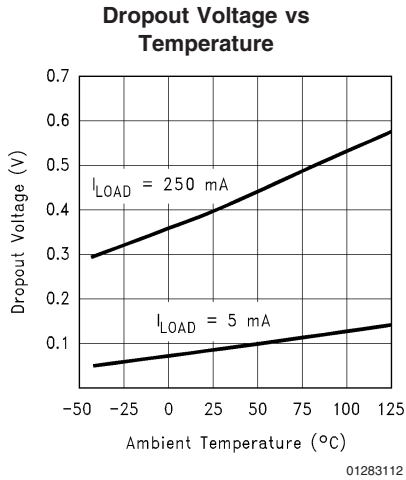

ON/OFF, Keep-Alive and Safety Latch-Off Control Diagrams

Note: If Keep-Alive is provided by a microprocessor powered by the output voltage of the LM9070, the logic "1" voltage level will track V_{OUT} as the regulator turns OFF.

**Simple ON/OFF control
(Keep-Alive input must be high to turn OFF output)**

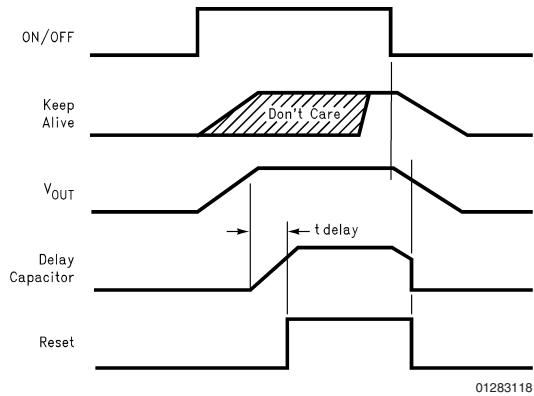

**Keep-Alive Mode; Turn ON with ON/OFF control,
Keep output biased with Keep-Alive input,
Turn OFF with Keep-Alive (Keep-Alive low keeps output ON, Keep-Alive going high turns output OFF)**

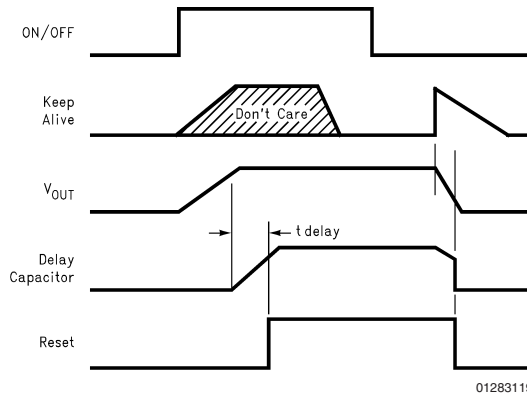

**Switch ON with ON/OFF input; Keep output biased with Keep-Alive; Hold output ON with ON/OFF; Turn OFF with ON/OFF input.
(Temporary Keep-Alive Mode)**

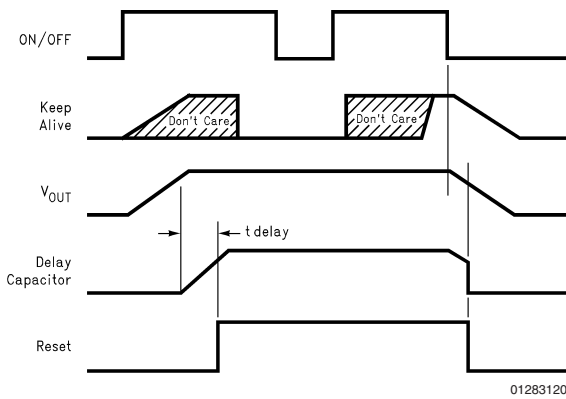

**Safety Latch OFF of V_{OUT} when in Keep-Alive Mode
(ON/OFF going high required to turn Output back ON)**

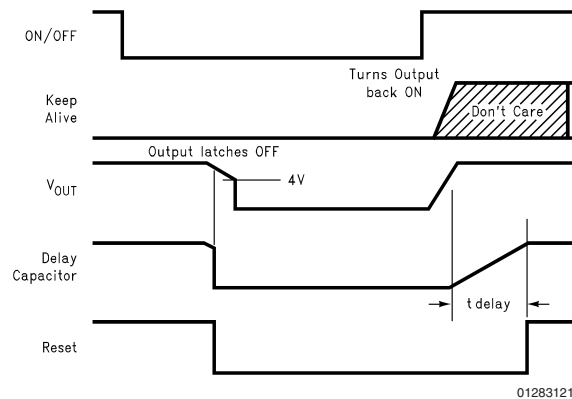

Control Logic Truth Table

ON/OFF Input	Keep-Alive Input	Output Voltage	Reset Output	Operating Condition
L	X	0V	L	Low quiescent current standby (OFF) condition
↑	X	5V	↑ after delay	Output turns ON
H	X	5V	H	Normal ON condition
↓	H	0V	L	Output turns OFF
↓	L	5V	H	Output kept ON by Keep-Alive Input
↑	L	5V	H	Output remains ON (or turns ON)
H	X	$\Delta V_{OUT} \geq -300 \text{ mV}$	L	Output pulled out of regulation, reset flag generated
L	L	$V_{OUT} \leq 4V$	L	Output latches OFF

Block Diagram

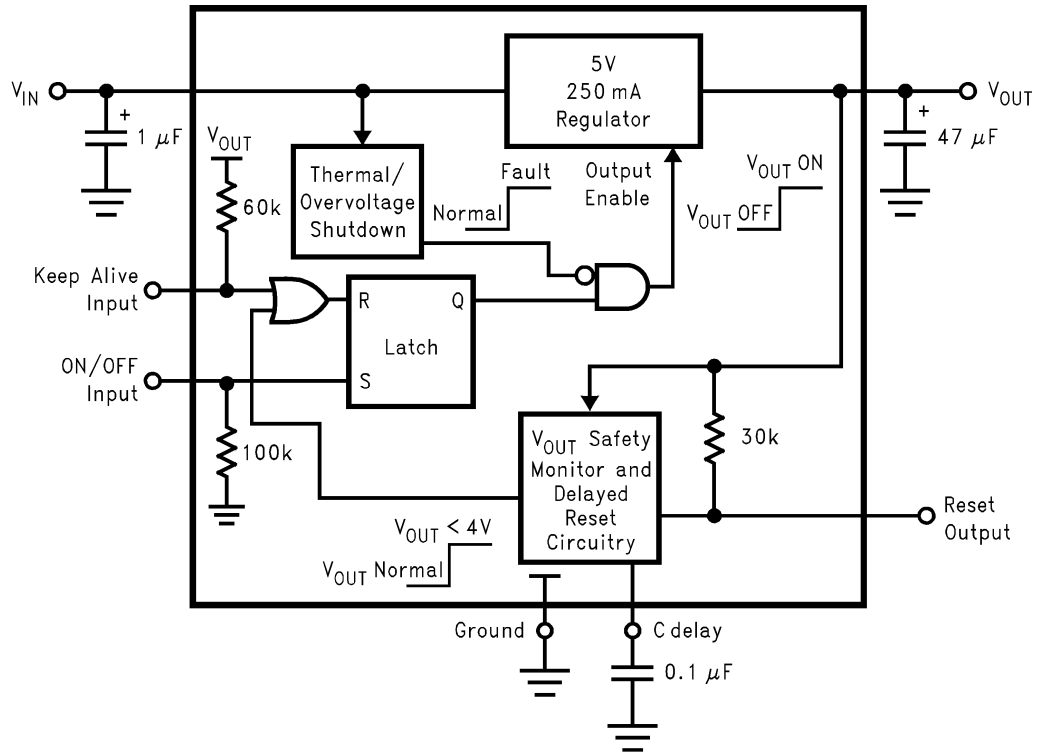

01283122

Application Information

The LM9070 voltage regulator has been optimized for use in microprocessor based automotive systems. Several unique design features have been incorporated to address many FMEA (Failure Mode Effects Analysis) concerns for fail-safe system performance.

FAULT TOLERANT FEATURES

While not specifically guaranteed due to production testing limitations, the LM9070 has been tested and shown to continue to provide a regulated output and, not generate an erroneous system reset signal while subjected to high levels of RF electric field energy (up to 300 V/m signal strength over a 2 MHz to 400 MHz frequency range). This is very important in vehicle safety related applications where the system must continue to operate normally. To maintain this immunity to RFI the output bypass capacitor is important (47 μ F is recommended).

This regulator is suitable for applications where continuous connection to the battery is required (*Refer to the Typical Application Circuit*). ON/OFF control of the regulator and system can be accomplished by switching the ON/OFF input to the battery or ignition supply V_{IN} supply through a SPST switch. If this input becomes open circuited, an internal pull-down resistor ensures that the regulator turns OFF. When the regulator is switched OFF the current load on the battery drops to less than 60 μ A. With the possibility in many applications for V_{IN} and the ON/OFF input pins to be connected in a system through long lengths of wire, the ESD protection of these pins has been increased to 12 kV with the addition of small input bypass capacitors.

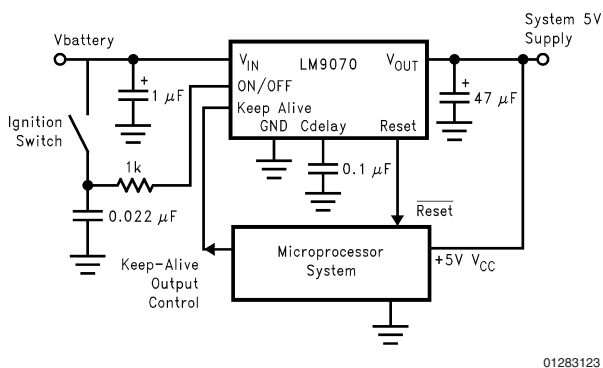

FIGURE 1. Typical Application Circuit

An output bypass capacitor of at least 10 μ F is required for stability (47 μ F is recommended). The ESR of this capacitor should be less than 3 Ω . An input capacitor of 1 μ F or larger is recommended to improve line transient and noise performance.

With the Keep-Alive input, a system microprocessor has the ability to keep the regulator ON (with a logic "0" on Keep-Alive) after the ON/OFF input has been commanded OFF. A power-down sequence, when system variables are typically stored in programmable memory, can be executed and take as much time as necessary. At the end of the operation the micro then pulls Keep-Alive high and the regulator and system turn OFF and revert to the low quiescent current standby mode.

For additional system reliability, consideration has been made for the possibility of a short circuited load at the output of the regulator. When the regulator is switched ON, conven-

tional current limiting and thermal shutdown protect the regulator. When the regulator is switched OFF however, a grounded V_{CC} supply to the micro (due to the shorted regulator output) will force the Keep-Alive input to be low and thus try to maintain the Keep-Alive mode of operation. With a shorted load, the drain on the battery could be as high as 1.5A. A separate internal circuit monitors the output voltage of the regulator. If V_{OUT} is less than 4V, as would be the case with a shorted load, the Keep-Alive function is logically disabled to ensure that the regulator turns OFF and reverts to only a 50 μ A load on the battery.

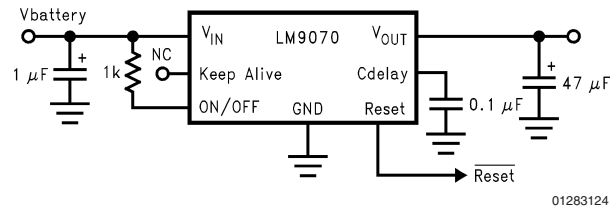

FIGURE 2. Control Logic Not Used

Conventional load dump protection is built in to withstand up to +60V and -50V transients. A 1 k Ω resistor in series with the ON/OFF and Keep-Alive inputs are recommended to provide the same level of transient protection for these pins if required. Protection against reverse polarity battery connections is also built in. With a reversed battery the output of the LM9070 will not go more negative than one diode drop below ground. This will prevent damage to any of the 5V load circuits.

For applications where the control logic is not required the logic pins should be configured as shown in *Figure 2*. A separate device, called the LM9071, can be used. The LM9071 is available in a 5-lead TO-220 package and does not provide control logic functions, but still retains all of the protection features of the LM9070.

RESET FLAG

Excessive loading of the output to the point where the output voltage drops by 300 mV to 500 mV will signal a reset flag to the micro. This will warn of a V_{CC} supply that may produce unpredictable operation of the system. On power-up and recovery from a fault condition the delay capacitor is used to hold the micro in a reset condition for a programmable time interval to allow the system operating voltages and clock to stabilize before executing code. The typical delay time interval can be estimated using the following equation:

$$t_{DELAY} = \frac{3.8V \times C_{DELAY}}{20 \mu A}$$

INPUT STABILITY

Low dropout voltage regulators which utilize a PNP power transistor usually exhibit a large increase in current when in dropout ($V_{IN} < 5.5V$). This increase is caused by the saturation characteristics (β reduction) of the PNP transistor. To significantly minimize this increase in current the LM9070 detects when the PNP enters saturation and reduces the operating current.

This reduction in input current can create a stability problem in applications with higher load current (> 100 mA) where the input voltage is applied through a long length of wire, which in effect adds a significant amount of inductance in

Application Information (Continued)

series with the input. The drop in input current may create a positive input voltage transient which may take the PNP out of saturation. If the input voltage is held constant at the threshold where the PNP is going in and out of saturation, an oscillation may be created.

This is only observed where significant series inductance is present in the input supply line and when the rise and fall time of the input supply is very slow. If the application and removal of the input voltage changes at a rate greater than 500 mV/ μ s, the input voltage moves through the dropout region of operation (V_{IN} of 3V to 5.5V) too quickly for an oscillation to be established.

MICROPROCESSOR SYSTEM REGULATOR WITH KEEP-ALIVE INTERVAL AT TURN-OFF

The following circuit illustrates a system application utilizing both of the logic control inputs of the LM9070. Closing the ON/OFF switch powers ON the system. Once powered, the system controller sets the Keep-Alive line low. The NPN transistor is used only to signal the controller that the ON/OFF switch has been opened and the system is to be turned OFF. Upon detecting this high level at the ON/OFF Sense input line, the controller can then perform a power down routine. The system will remain fully powered until the controller commands total shut down by taking the Keep-Alive line high. The system then shuts OFF and reverts to a very low current drain standby condition until switched back on.

Application Information (Continued)

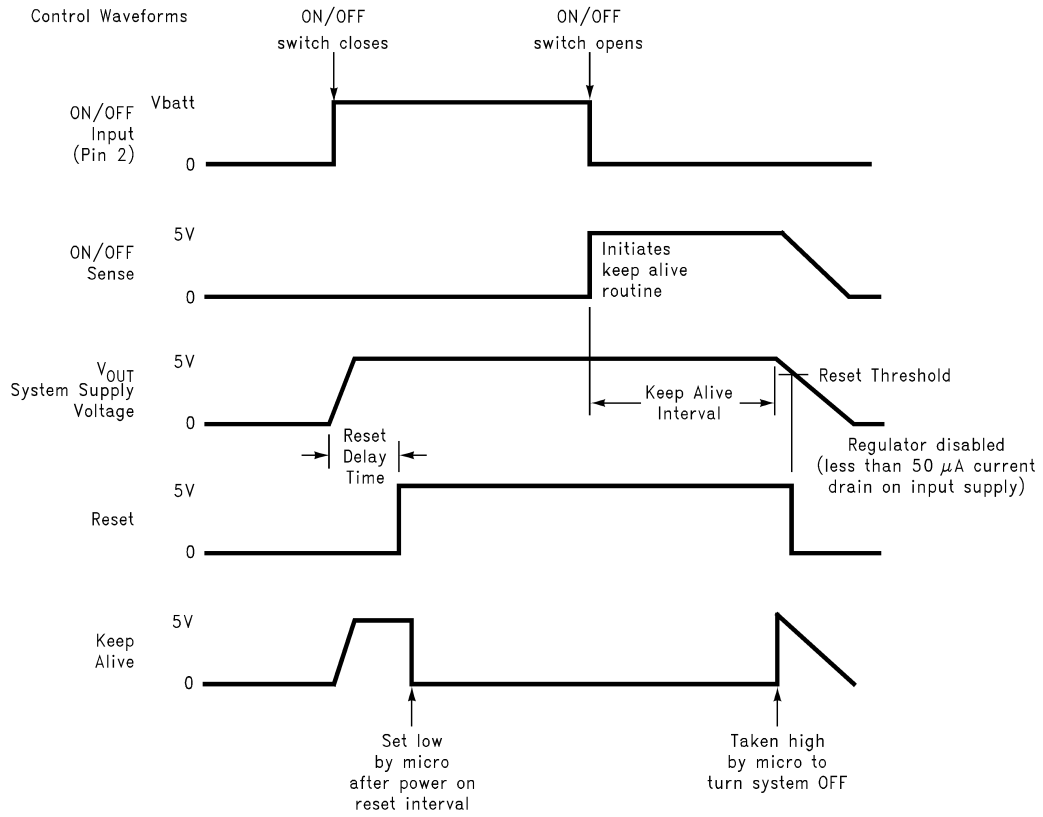
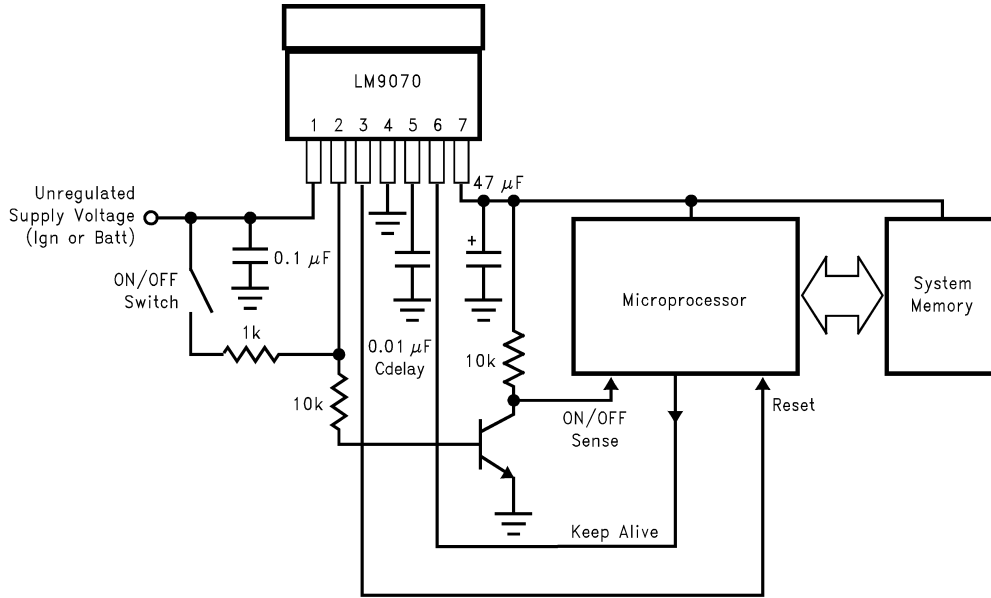

01283125

Application Information (Continued)

THERMAL MANAGEMENT

The LM9070 is packaged in both a TO-263 surface mount power package and a narrow lead-pitch TO-220 package. To obtain operation over the highest possible load current and input voltage ranges, care must be taken to control the operating temperature of the device. Thermal shutdown protection is built in, with a threshold above 150°C. Conventional heat-sinking techniques can be used with the TO-220 package. When applying the TO-263 package, on board heat-sinking is important to prevent premature thermal shutdown. More copper foil area under the tab of the device will directly improve the operating θ_{J-A} of the TO-263 package, which will reduce the junction temperature of the device.

The θ_{J-A} value for the TO-263 package (still air, no additional heat sink) is rated at 80°C/W. The effective θ_{J-A} value of the

TO-263 package can be reduced by increasing the printed circuit board area that is connected (soldered) to the package tab. Using 1 ounce (1.4 mils thick) copper clad with no solder mask, an area of 0.5 square inches will reduce θ_{J-A} to 50°C/W, an area of 1.0 square inches will reduce θ_{J-A} to 37°C/W, and an area of 1.6 square inches will reduce θ_{J-A} to 32°C/W. If the printed circuit board uses a solder mask, the copper clad area under the solder mask should be increased by at least 50% to maintain a similar θ_{J-A} rating.

The use of a double sided PC board with soldered filled vias between two planes of copper, as shown in Figure 3, will improve thermal performance while optimizing the PC board surface area required. Using the double sided PC board arrangement shown in Figure 3, with 1 ounce (1.4 mils thick) copper clad with no solder mask and solder filled vias, an area of 0.5 square inches on both sides will reduce θ_{J-A} to 43°C/W.

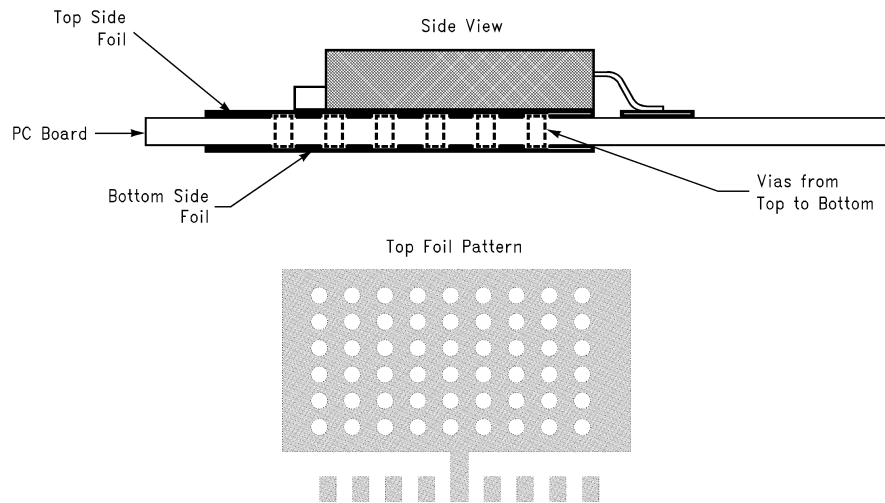

01283127

FIGURE 3. Typical TO-263 PC Board Heatsinking

Notes

National does not assume any responsibility for use of any circuitry described, no circuit patent licenses are implied and National reserves the right at any time without notice to change said circuitry and specifications.

For the most current product information visit us at www.national.com.

LIFE SUPPORT POLICY

NATIONAL'S PRODUCTS ARE NOT AUTHORIZED FOR USE AS CRITICAL COMPONENTS IN LIFE SUPPORT DEVICES OR SYSTEMS WITHOUT THE EXPRESS WRITTEN APPROVAL OF THE PRESIDENT AND GENERAL COUNSEL OF NATIONAL SEMICONDUCTOR CORPORATION. As used herein:

1. Life support devices or systems are devices or systems which, (a) are intended for surgical implant into the body, or (b) support or sustain life, and whose failure to perform when properly used in accordance with instructions for use provided in the labeling, can be reasonably expected to result in a significant injury to the user.
2. A critical component is any component of a life support device or system whose failure to perform can be reasonably expected to cause the failure of the life support device or system, or to affect its safety or effectiveness.

BANNED SUBSTANCE COMPLIANCE

National Semiconductor manufactures products and uses packing materials that meet the provisions of the Customer Products Stewardship Specification (CSP-9-111C2) and the Banned Substances and Materials of Interest Specification (CSP-9-111S2) and contain no "Banned Substances" as defined in CSP-9-111S2.



National Semiconductor
Americas Customer
Support Center
Email: new.feedback@nsc.com
Tel: 1-800-272-9959

National Semiconductor
Europe Customer Support Center
Fax: +49 (0) 180-530 85 86
Email: europe.support@nsc.com
Deutsch Tel: +49 (0) 69 9508 6208
English Tel: +44 (0) 870 24 0 2171
Français Tel: +33 (0) 1 41 91 8790

National Semiconductor
Asia Pacific Customer
Support Center
Email: ap.support@nsc.com

National Semiconductor
Japan Customer Support Center
Fax: 81-3-5639-7507
Email: jpn.feedback@nsc.com
Tel: 81-3-5639-7560

www.national.com