

8-Bit Serial-in/Parallel-out Shift Register

MM74HCT164

Description

The MM74HCT164 utilizes advanced silicon-gate CMOS technology. It has the high noise immunity and low consumption of standard CMOS integrated circuits. It also offers speeds comparable to low power Schottky devices. This 8-bit shift register has gated serial inputs and CLEAR. Each register bit is a D-type master/slave flip-flop. Inputs A & B permit complete control over the incoming data. A LOW at either or both inputs inhibits entry of new data and resets the first flip-flop to the low level at the next clock pulse. A high level on one input enables the other input which will then determine the state of the first flip-flop. Data at the serial inputs may be changed while the clock is HIGH or LOW, but only information meeting the setup and hold time requirements will be entered. Data is serially shifted in and out of the 8-bit register during the positive going transition of the clock pulse. Clear is independent of the clock and accomplished by a low level at the CLEAR input.

The 74HCT logic family is functionally as well as pin-out compatible with the standard 74LS logic family. All inputs are protected from damage due to static discharge by internal diode clamps to V_{CC} and ground.

MM74HCT devices are intended to interface between TTL and NMOS components and standard CMOS devices. These parts are also plug-in replacements for LS-TTL devices and can be used to reduce power consumption in existing designs.

Features

- Typical Propagation Delay: 20 ns
- Low Quiescent Current: 160 μ A Maximum (74HCT Series)
- Low Input Current: 1 μ A Maximum
- Fanout of 10 LS-TTL Loads
- TTL Input Compatible
- These are Pb-Free Devices

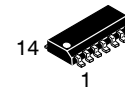

SOIC-14
CASE 751EF

MARKING DIAGRAM

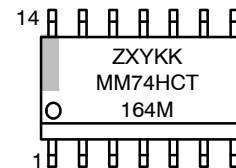

MM74HCT164M = Specific Device Code
Z = Assembly Plant Code
XY = Data Code (Year & Week)
KK = Lot Traceability Code

CONNECTION DIAGRAM

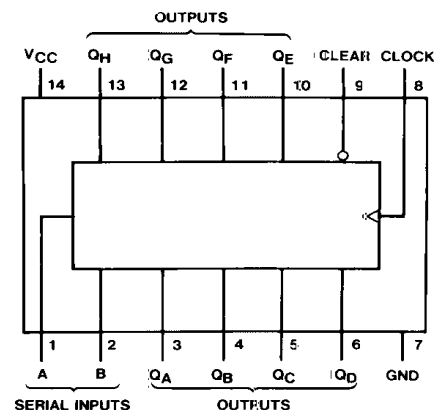

(Top View)

ORDERING INFORMATION

Device	Package	Shipping [†]
MM74HCT164MX	SOIC-14 (Pb-Free)	2500 / Tape & Reel

[†]For information on tape and reel specifications, including part orientation and tape sizes, please refer to our Tape and Reel Packaging Specifications Brochure, [BRD8011/D](#).

MM74HCT164

TRUTH TABLE

Inputs				Outputs			
Clear	Clock	A	B	Q _A	Q _B	...	Q _H
L	X	X	X	L	L		L
H	L	X	X	Q _{AO}	Q _{BO}		Q _{HO}
H	↑	H	H	H	Q _{An}		Q _{Gn}
H	↑	L	X	L	Q _{An}		Q _{Gn}
H	↑	X	L	L	Q _{An}		Q _{Gn}

H = HIGH Level (steady state)

L = LOW Level (steady state)

X = Irrelevant (any input, including transitions)

↑ = Transition from LOW-to-HIGH level

Q_{AO}, Q_{BO}, Q_{HO} = the level of Q_A, Q_B, or Q_H, respectively, before the indicated steady state input conditions were established.

Q_{An}, Q_{Gn} = The level of Q_A or Q_G before the most recent ↑ transition of the clock; indicated a one-bit shift.

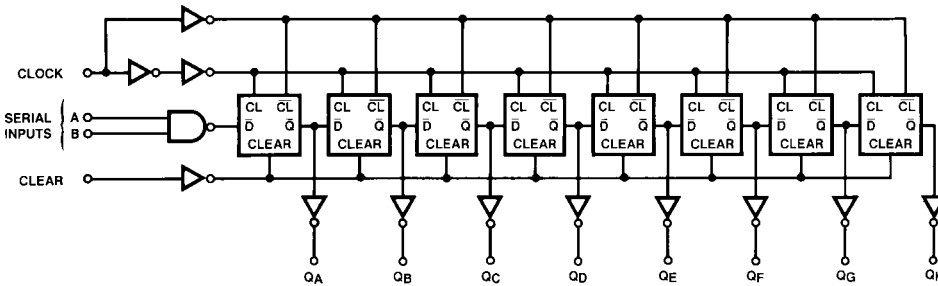

Figure 1. Logic Diagram

ABSOLUTE MAXIMUM RATINGS (Note 1)

Symbol	Parameter	Value	Unit
V _{CC}	Supply Voltage	-0.5 to +6.5	V
V _{IN}	DC Input Voltage	-0.5 to V _{CC} + 0.5	V
V _{OUT}	DC Output Voltage	-0.5 to V _{CC} + 0.5	V
I _{IK} , I _{OK}	Clamp Diode Current	±20	mA
I _{OUT}	DC Output Current, per Pin	±25	mA
I _{CC}	DC V _{CC} or GND Current, per Pin	±50	mA
T _{STG}	Storage Temperature Range	-65 to +150	°C
P _D	Power Dissipation	SOIC-14	1077
		TSSOP-14	833
T _L	Lead Temperature (Soldering 10 seconds)	260	°C

Stresses exceeding those listed in the Maximum Ratings table may damage the device. If any of these limits are exceeded, device functionality should not be assumed, damage may occur and reliability may be affected.

1. Unless otherwise specified all voltages are referenced to ground.

MM74HCT164

RECOMMENDED OPERATING CONDITIONS

Symbol	Parameter	Min	Max	Unit
V_{CC}	Supply Voltage	4.5	5.5	V
V_{IN}, V_{OUT}	DC Input or Output Voltage	0	V_{CC}	V
T_A	Operating Temperature Range	-55	+125	°C
t_r, t_f	Input Rise or Fall Times	-	500	ns

DC ELECTRICAL CHARACTERISTICS ($V_{CC} = 5\text{ V} \pm 10\%$ unless otherwise specified)

Symbol	Parameter	Conditions	$T_A = 25^\circ\text{C}$		$T_A = -40^\circ\text{C}$ to 85°C	$T_A = -55^\circ\text{C}$ to 125°C	Unit
			Typ	Guaranteed Limits			
V_{IH}	Minimum HIGH Level Input Voltage		-	2.0	2.0	2.0	V
V_{IL}	Maximum LOW Level Input Voltage		-	0.8	0.8	0.8	V
V_{OH}	Minimum HIGH Level Output Voltage	$V_{IN} = V_{IH}$ or V_{IL} $ I_{OUT} = 20\ \mu\text{A}$ $ I_{OUT} = 4.0\ \text{mA}, V_{CC} = 4.5\ \text{V}$ $ I_{OUT} = 4.8\ \text{mA}, V_{CC} = 5.5\ \text{V}$	V_{CC} 4.2 5.2	$V_{CC} - 0.1$ 3.98 4.98	$V_{CC} - 0.1$ 3.84 4.84	$V_{CC} - 0.1$ 3.7 4.7	V
V_{OL}	Maximum LOW Level Voltage	$V_{IN} = V_{IH}$ or V_{IL} $ I_{OUT} = 20\ \mu\text{A}$ $ I_{OUT} = 4.0\ \text{mA}, V_{CC} = 4.5\ \text{V}$ $ I_{OUT} = 4.8\ \text{mA}, V_{CC} = 5.5\ \text{V}$	0 0.2 0.2	0.1 0.26 0.26	0.1 0.33 0.33	0.1 0.4 0.4	V
I_{IN}	Maximum Input Current	$V_{IN} = V_{CC}$ or GND	-	± 0.1	± 1.0	± 1.0	μA
I_{CC}	Maximum Quiescent Supply Current	$V_{IN} = V_{CC}$ or GND, $I_{OUT} = 0\ \mu\text{A}$	-	8.0	80	160	μA
		$V_{IN} = 2.4\ \text{V}$ or $0.4\ \text{V}$ (Note 2)	-	1.0	1.3	1.5	mA

2. This is measured per input pin. All other inputs are held at V_{CC} or ground.

AC ELECTRICAL CHARACTERISTICS ($V_{CC} = 5\ \text{V}, T_A = 25^\circ\text{C}, C_L = 15\ \text{pF}, t_r = t_f = 6\ \text{ns}$)

Symbol	Parameter	Conditions	Typ	Guaranteed Limit	Unit
f_{MAX}	Maximum Operating Frequency from Clock to Q	50% Duty Cycle Clock	55	35	MHz
t_{PHL}, t_{PLH}	Maximum Propagation Delay, Clock to Q		17	27	ns
t_{PHL}	Maximum Propagation Delay, from Clear to Q		23	38	ns
t_{REM}	Minimum Removal Time, Clear to Clock		3	6	ns
t_S	Minimum Setup Time, Data to Clock	$t_H \geq 20\ \text{ns}$	6	13	ns
t_H	Minimum Hold Time, Clock to Data	$t_S \geq 20\ \text{ns}$	1.5	5	ns
t_W	Minimum Pulse Width, Preset or Clear		9	16	ns

MM74HCT164

AC ELECTRICAL CHARACTERISTICS ($V_{CC} = 5.0\text{ V}, \pm 10\%$, $C_L = 50\text{ pF}$, $t_r = t_f = 6\text{ ns}$ unless otherwise specified)

Symbol	Parameter	Conditions	$T_A = 25^\circ\text{C}$		$T_A = -40^\circ\text{C to } 85^\circ\text{C}$		$T_A = -55^\circ\text{C to } 125^\circ\text{C}$		Unit
			Typ	Max	Min	Max	Min	Max	
f_{MAX}	Maximum Operating Frequency	50% Duty Cycle Clock	45	30	-	25	-	22	MHz
t_{PHL}, t_{PLH}	Maximum Propagation Delay, from Clock to Q		20	30	-	38	-	45	ns
t_{PHL}	Maximum Propagation Delay, from Clear to Q		26	41	-	51	-	61	ns
t_{REM}	Minimum Removal Time, Clear to Clock		4	8	-	10	-	14	ns
t_S	Minimum Setup Time, Data to Clock	$t_H \geq 20\text{ ns}$	7	15	-	19	-	23	ns
t_H	Minimum Hold Time, Clock to Data	$t_S \geq 20\text{ ns}$	1.5	5	-	5	-	5	ns
t_W	Minimum Pulse Width, Clock or Clear		10	18	-	22	-	27	ns
t_r, t_f	Maximum Input Rise and Fall Time		-	500	-	500	-	500	ns
t_{TLH}, t_{THL}	Maximum Output Rise and Fall Time		-	15	-	19	-	22	ns
C_{PD}	Power Dissipation Capacitance (Note 3)		160	-	-	-	-	-	pF
C_{IN}	Maximum Input Capacitance		5	10	-	10	-	10	pF

3. C_{PD} determines the no load dynamic power consumption, $P_D = C_{PD} V_{CC}^2 f + I_{CC} V_{CC}$, and the no load dynamic current consumption, $I_S = C_{PD} V_{CC} f + I_{CC}$.

MECHANICAL CASE OUTLINE
PACKAGE DIMENSIONS

ON Semiconductor®



SOIC14
CASE 751EF
ISSUE O

DATE 30 SEP 2016

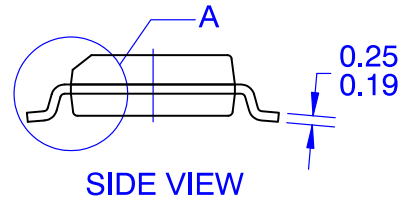
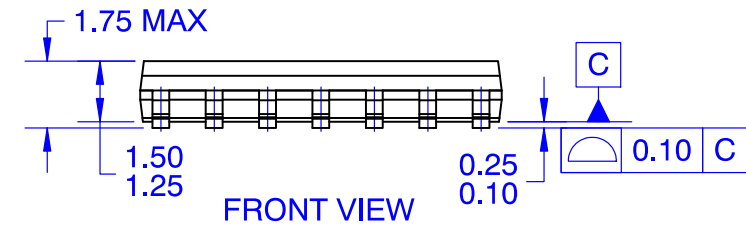
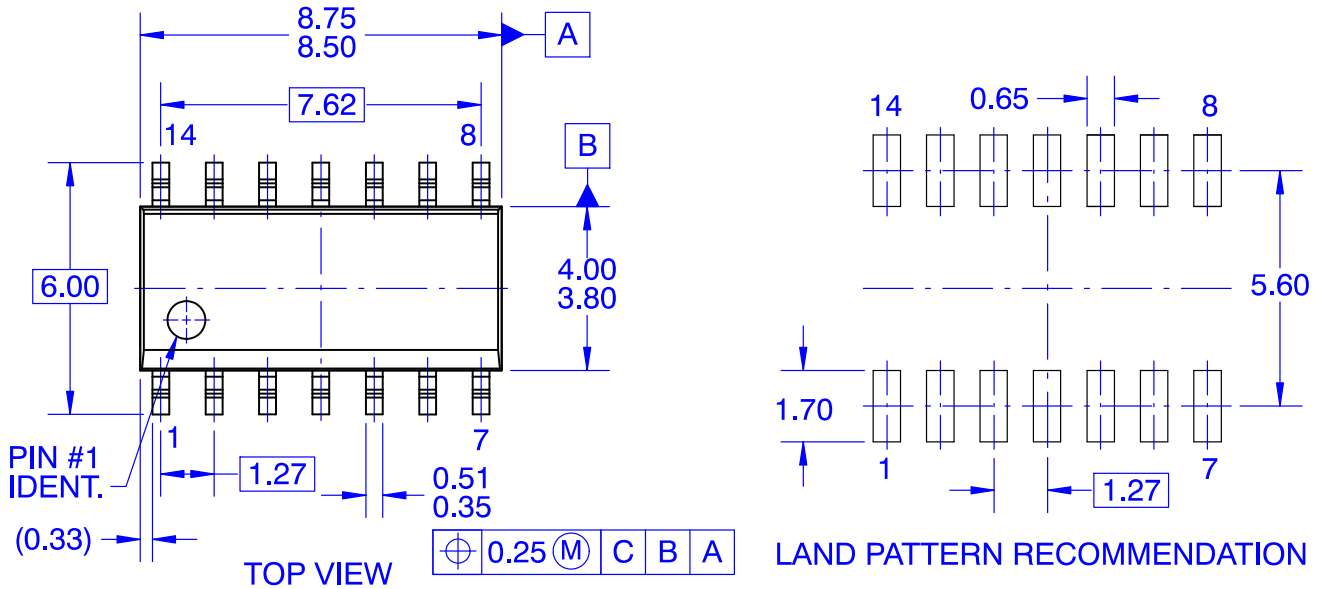

NOTES:

- A. CONFORMS TO JEDEC MS-012, VARIATION AB, ISSUE C
- B. ALL DIMENSIONS ARE IN MILLIMETERS
- C. DIMENSIONS DO NOT INCLUDE MOLD FLASH OR BURRS
- D. LAND PATTERN STANDARD: SOIC127P600X145-14M
- E. CONFORMS TO ASME Y14.5M, 2009

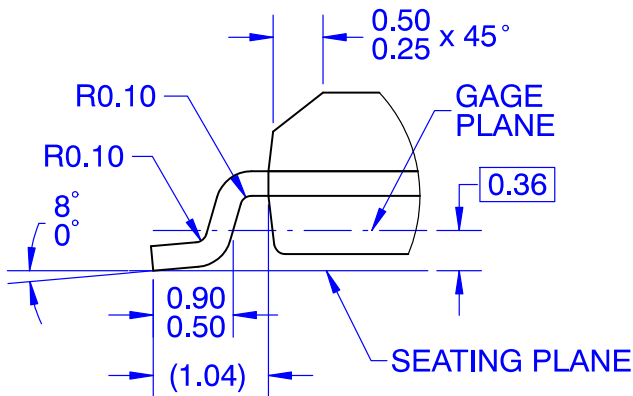

DETAIL A
SCALE 16 : 1

DOCUMENT NUMBER:	98AON13739G	Electronic versions are uncontrolled except when accessed directly from the Document Repository. Printed versions are uncontrolled except when stamped "CONTROLLED COPY" in red.
DESCRIPTION:	SOIC14	PAGE 1 OF 1

ON Semiconductor and are trademarks of Semiconductor Components Industries, LLC dba ON Semiconductor or its subsidiaries in the United States and/or other countries. ON Semiconductor reserves the right to make changes without further notice to any products herein. ON Semiconductor makes no warranty, representation or guarantee regarding the suitability of its products for any particular purpose, nor does ON Semiconductor assume any liability arising out of the application or use of any product or circuit, and specifically disclaims any and all liability, including without limitation special, consequential or incidental damages. ON Semiconductor does not convey any license under its patent rights nor the rights of others.

onsemi, **Onsemi**, and other names, marks, and brands are registered and/or common law trademarks of Semiconductor Components Industries, LLC dba "**onsemi**" or its affiliates and/or subsidiaries in the United States and/or other countries. **onsemi** owns the rights to a number of patents, trademarks, copyrights, trade secrets, and other intellectual property. A listing of **onsemi**'s product/patent coverage may be accessed at www.onsemi.com/site/pdf/Patent-Marking.pdf. **onsemi** reserves the right to make changes at any time to any products or information herein, without notice. The information herein is provided "as-is" and **onsemi** makes no warranty, representation or guarantee regarding the accuracy of the information, product features, availability, functionality, or suitability of its products for any particular purpose, nor does **onsemi** assume any liability arising out of the application or use of any product or circuit, and specifically disclaims any and all liability, including without limitation special, consequential or incidental damages. Buyer is responsible for its products and applications using **onsemi** products, including compliance with all laws, regulations and safety requirements or standards, regardless of any support or applications information provided by **onsemi**. "Typical" parameters which may be provided in **onsemi** data sheets and/or specifications can and do vary in different applications and actual performance may vary over time. All operating parameters, including "Typicals" must be validated for each customer application by customer's technical experts. **onsemi** does not convey any license under any of its intellectual property rights nor the rights of others. **onsemi** products are not designed, intended, or authorized for use as a critical component in life support systems or any FDA Class 3 medical devices or medical devices with a same or similar classification in a foreign jurisdiction or any devices intended for implantation in the human body. Should Buyer purchase or use **onsemi** products for any such unintended or unauthorized application, Buyer shall indemnify and hold **onsemi** and its officers, employees, subsidiaries, affiliates, and distributors harmless against all claims, costs, damages, and expenses, and reasonable attorney fees arising out of, directly or indirectly, any claim of personal injury or death associated with such unintended or unauthorized use, even if such claim alleges that **onsemi** was negligent regarding the design or manufacture of the part. **onsemi** is an Equal Opportunity/Affirmative Action Employer. This literature is subject to all applicable copyright laws and is not for resale in any manner.

ADDITIONAL INFORMATION

TECHNICAL PUBLICATIONS:

Technical Library: www.onsemi.com/design/resources/technical-documentation
onsemi Website: www.onsemi.com

ONLINE SUPPORT: www.onsemi.com/support

For additional information, please contact your local Sales Representative at www.onsemi.com/support/sales