

62429-1 ✓ ACTIVE

MAG-MATE | MAG-MATE 300

TE Internal #: 62429-1

Poke-In, Mating Tab Width 3.4 mm [.135 in], Size 2, 28 – 25 AWG

Aluminum Wire, .32 – .45 mm Aluminum Wire, MAG-MATE 300,

Magnet Wire Terminals

[View on TE.com >](#)



Terminals & Splices > Magnet Wire Terminals

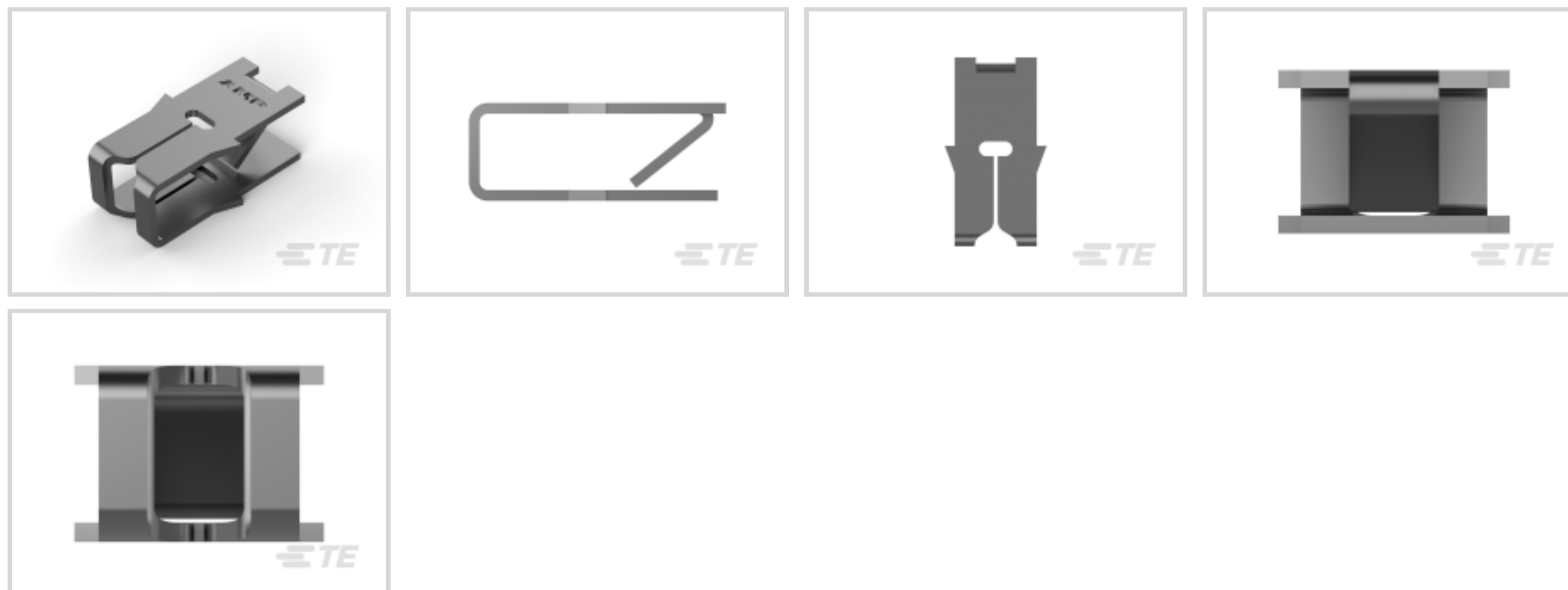

Magnet Wire Terminal Type: **Poke-In**

Mating Tab Width: **3.4 mm [.135 in]**

Mating Tab Thickness: **.5 mm [.02 in]**

Compatible With Cavity Size: **Size 2**

Aluminum Wire Size: **28 – 25 AWG**

Features

Product Type Features

Compatible With Discrete Wire Type	Magnet Wire, Solid
------------------------------------	--------------------

Body Features

Compatible With Cavity Size	Size 2
-----------------------------	--------

Contact Features

Crimp Type	IDC
Magnet Wire Terminal Type	Poke-In
Mating Tab Width	3.4 mm [.135 in]
Mating Tab Thickness	.5 mm [.02 in]
Terminal Plating Material	Tin
Terminal Orientation	Straight

Termination Features

Termination Method to Wire & Cable	Insulation Displacement (IDC)
------------------------------------	-------------------------------

Mechanical Attachment



Mating Retention Type	Locking
-----------------------	---------

Dimensions

Terminal Height	7.62 mm[.3 in]
Aluminum Wire Size	.32 – .45 mm
Lead Wire Size	.5 – .9 mm ²
Magnet Wire Size	.25 – .36 mm
Stock Thickness (Magnet Wire Side)	.3 mm[.012 in]
Product Length	3.43 mm[.135 in]

Usage Conditions

Insulation Option	Uninsulated
Operating Temperature Range	-65 – 150 °C[-85 – 302 °F]

Operation/Application

Compatible With Wire Base Material	Aluminum, Copper
------------------------------------	------------------

Identification Marking

Identification Number	6
-----------------------	---

Packaging Features

Packaging Quantity	12000
Packaging Method	Reel, Reel/Carton

Product Compliance





[For compliance documentation, visit the product page on TE.com>](#)

EU RoHS Directive 2011/65/EU	Compliant
EU ELV Directive 2000/53/EC	Compliant
China RoHS 2 Directive MIIT Order No 32, 2016	No Restricted Materials Above Threshold
EU REACH Regulation (EC) No. 1907/2006	Current ECHA Candidate List: JUNE 2024 (241) Candidate List Declared Against: JUNE 2024 (241) Does not contain REACH SVHC
Halogen Content	Low Halogen - Br, Cl, F, I < 900 ppm per homogenous material. Also BFR/CFR/PVC Free
Solder Process Capability	Not applicable for solder process capability

Product Compliance Disclaimer

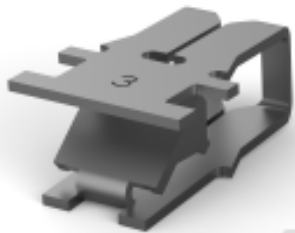
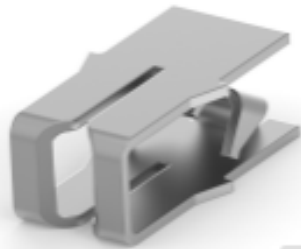
This information is provided based on reasonable inquiry of our suppliers and represents our current actual knowledge based on the information they provided. This information is subject to change. The part numbers that TE has identified as EU RoHS compliant have a maximum concentration of 0.1% by weight in homogenous materials for lead, hexavalent chromium, mercury, PBB, PBDE, DBP, BBP, DEHP, DIBP, and 0.01% for cadmium, or qualify for an exemption to these limits as defined in the Annexes of Directive 2011/65/EU (RoHS2). Finished electrical and electronic equipment products will be CE marked as required by Directive 2011/65/EU. Components may not be CE marked. Additionally, the part numbers that TE has identified as EU ELV compliant have a maximum concentration of 0.1% by weight in homogenous materials for lead, hexavalent chromium, and mercury, and 0.01% for cadmium, or qualify for an exemption to these limits as defined in the Annexes of Directive 2000/53/EC (ELV). Regarding the REACH Regulation, the information TE provides on SVHC in articles for this part number is based on the latest European Chemicals Agency (ECHA) 'Guidance on requirements for substances in articles' posted at this URL: <https://echa.europa.eu/guidance-documents/guidance-on-reach>

Compatible Parts

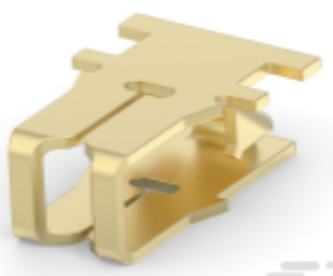
 <p>TE Part # 1217234-1 MAG-MATE TERM 28-31 013TPBR</p>	 <p>TE Part # 1742379-1 TERMINAL,POKE-IN,MAG-MATE</p>	 <p>TE Part # 63590-1 MAG-MATE LEAF CONTACT 0126TPBR</p>	 <p>TE Part # 63590-3 MAG-MATE LEAF CONT 0126 TPPHBZ</p>
 <p>TE Part # 63885-1 TERM MAG-MATE 27-30 013TPBR</p>	 <p>TE Part # 1-62429-2 MAG-MATE TERM 27-30 013TPBR</p>	 <p>TE Part # 926851-2 MAG MATE LEAF KONT</p>	 <p>TE Part # 1-964108-1 MAG-MATE KONTAKT</p>
 <p>TE Part # 160899-4 MAG-MATE POKE-IN</p>	 <p>TE Part # 62429-2 MAG-MATE TERM 27-30 013TPBR</p>	 <p>TE Part # 62429-4 MAG-MATE TERM 27-30 013BR</p>	 <p>TE Part # 63590-2 MAG-MATE LEAF CONTACT 0126TPBR</p>

Also in the Series | **MAG-MATE 300**



Magnet Wire Terminals(78)

Customers Also Bought

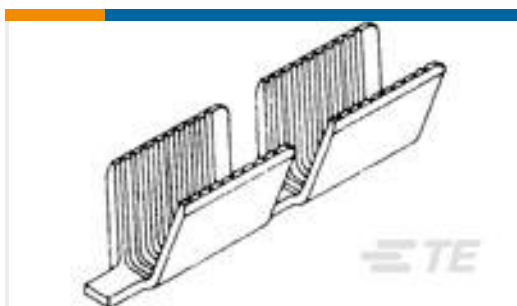
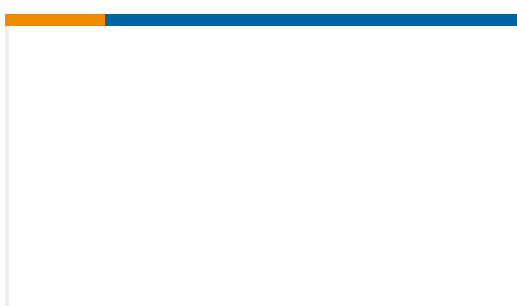
TE Part #170140-2
187 FASTON,FLAG,REC.,16-20 AWG,
TPBRTE Part #63658-1
MAG MATE TERM 25-22 016TPBRTE Part #2443729-5
PLUG HOUSING SDL2.5
WATERPROOF 5PINTE Part #690588-1
INSULATION CRIMPERTE Part #62306-2
AMVAR SPLC 1500-5000 020TPBRTE Part #62306-1
SPLICE, AMPLIVARTE Part #62420-9
MAG-MATE TERM 20-22 016TE Part #3-1983661-1
TAB CONTACT MULTI 6P
CONNECTORTE Part #3-1983666-1
2 POS DOUBLE LOCK PLATE MULTI
6P CONNECTE Part #572280-1
GRAMPEADOR DO FIO

Documents

Product Drawings

[MAG-MATE TERM 27-30 013TPBR](#)

English

CAD Files

[3D PDF](#)

3D

[Customer View Model](#)

[ENG_CVM_CVM_62429-1_CE.2d_dxf.zip](#)



English

Customer View Model

[ENG_CVM_CVM_62429-1_CE.3d_igs.zip](#)

English

Customer View Model

[ENG_CVM_CVM_62429-1_CE.3d_stp.zip](#)

English

By downloading the CAD file I accept and agree to the [Terms and Conditions](#) of use.

Datasheets & Catalog Pages

[Magnet Wire Terminals & Splices](#)

English

Product Specifications

[Application Specification](#)

English

Agency Approvals

[UL Report](#)

English