

# Surface Mount Low Pass Filter

## SCLF-36+

50Ω DC to 36 MHz

### Maximum Ratings

Operating Temperature	-40°C to 85°C
Storage Temperature	-55°C to 100°C
RF Power Input	0.5W max.

Permanent damage may occur if any of these limits are exceeded.

### Pin Connections

INPUT	1
OUTPUT	8
GROUND	2,3,4,5,6,7

### Outline Drawing

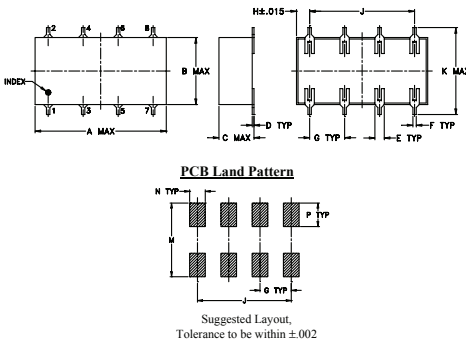

### Outline Dimensions (inch)

A	B	C	D	E	F	G
0.75	0.38	0.28	0.01	0.05	0.02	0.2
19.05	9.65	7.11	0.25	1.27	0.51	5.08

H	J	K	M	N	P	wt
0.075	0.6	0.45	0.47	0.1	0.15	grams
1.91	15.24	11.43	11.94	2.54	3.81	1.60

### Demo Board MCL P/N: TB-187+ Suggested PCB Layout (PL-049)

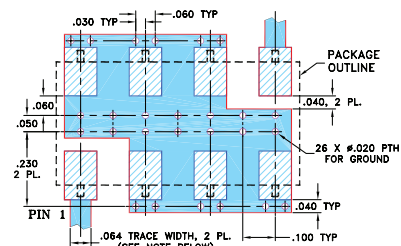

- NOTES:**
- TRACE WIDTH IS SHOWN FOR ROGERS RO4350B WITH DIELECTRIC THICKNESS .030" ± .002"; COPPER: 1/2 OZ. EACH SIDE. FOR OTHER MATERIALS TRACE WIDTH MAY NEED TO BE MODIFIED.
  - BOTTOM SIDE OF THE PCB IS CONTINUOUS GROUND PLANE.
- DENOTES PCB COPPER LAYOUT WITH SMOBC (SOLDER MASK OVER BARE COPPER)
- DENOTES COPPER LAND PATTERN FREE OF SOLDER MASK

#### Notes

- Performance and quality attributes and conditions not expressly stated in this specification document are intended to be excluded and do not form a part of this specification document.
- Electrical specifications and performance data contained in this specification document are based on Mini-Circuit's applicable established test performance criteria and measurement instructions.
- The parts covered by this specification document are subject to Mini-Circuit's standard limited warranty and terms and conditions (collectively, "Standard Terms"); Purchasers of this part are entitled to the rights and benefits contained therein. For a full statement of the Standard Terms and the exclusive rights and remedies thereunder, please visit Mini-Circuit's website at [www.minicircuits.com/MCLStore/terms.jsp](http://www.minicircuits.com/MCLStore/terms.jsp)

### Features

- wide selection of cut-off frequencies
- excellent rejection
- custom models available

### Applications

- defense communications
- receivers/transmitters
- harmonic rejection of VCOs



Generic photo used for illustration purposes only  
CASE STYLE: YY161

### +RoHS Compliant

The +Suffix identifies RoHS Compliance. See our web site for RoHS Compliance methodologies and qualifications

### Electrical Specifications

Parameter	F#	Frequency (MHz)	Min.	Typ.	Max.	Unit	
Pass Band	Insertion Loss	DC-F1	DC-36	—	—	1.0	dB
	Freq. Cut-Off	F2	40	—	3.0	—	dB
	VSWR	DC-F1	DC-36	—	1.3	—	:1
Stop Band	Rejection Loss	F3-F4	50-57	20	—	—	dB
		F4-F5	57-390	40	—	—	dB
	VSWR	F3-F5	50-390	—	18	—	:1

### Typical Frequency Response

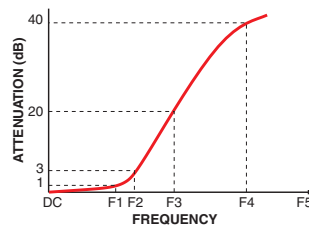

### Electrical Schematic

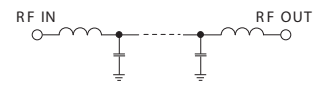

### Typical Performance Data

Frequency (MHz)	Insertion Loss (dB)		Return Loss (dB)
	$\bar{x}$	$\sigma$	
0.5	0.04	0.01	44.37
10.0	0.12	0.01	23.43
21.0	0.19	0.00	37.01
36.0	0.69	0.02	30.06
38.0	1.01	0.09	20.37
40.0	2.15	0.43	9.08
41.0	3.46	0.75	5.67
42.0	5.43	1.10	3.42
47.0	20.04	1.73	0.51
50.0	29.32	1.89	0.31
53.5	40.73	2.28	0.22
57.0	55.47	3.70	0.17
75.0	70.03	1.62	0.10
100.0	64.38	1.98	0.13
250.0	55.42	0.41	0.19
390.0	52.74	0.39	0.23
410.0	45.55	0.30	0.26
475.0	34.55	0.53	0.32
600.0	58.90	4.73	0.40
700.0	13.15	4.92	5.40

### INSERTION LOSS

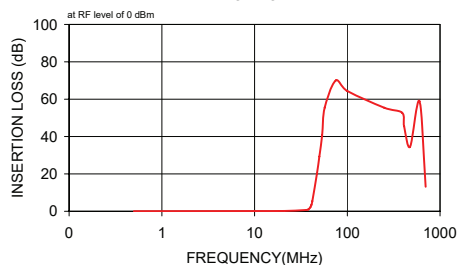

### RETURN LOSS

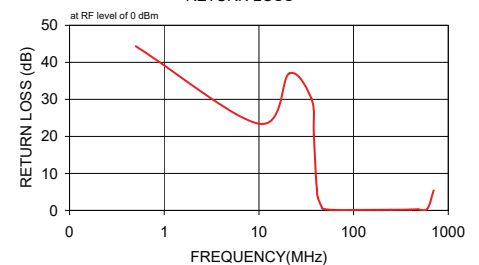

# Surface Mount Low Pass Filter

# SCLF-36+

## Typical Performance Data

FREQ. (MHz)	INSERTION LOSS (dB)			INPUT RETURN LOSS (dB)			OUTPUT RETURN LOSS (dB)		
	@ -40° C	@ +25° C	@ +85° C	@ -40° C	@ +25° C	@ +85° C	@ -40° C	@ +25° C	@ +85° C
0.5	0.02	0.02	0.03	44.46	44.35	43.93	45.04	44.66	44.28
10.0	0.10	0.11	0.12	22.58	22.78	23.06	22.52	22.72	22.96
21.0	0.15	0.17	0.18	38.57	39.69	39.63	38.19	38.88	38.56
30.0	0.33	0.34	0.37	24.93	25.63	26.28	25.46	26.24	27.02
31.0	0.37	0.37	0.41	25.76	26.41	27.13	26.42	27.16	27.98
32.0	0.41	0.42	0.46	26.80	27.34	28.09	27.48	28.08	28.91
33.0	0.45	0.45	0.50	27.75	28.03	28.72	28.24	28.53	29.18
34.0	0.49	0.50	0.55	27.80	27.65	28.07	27.76	27.55	27.86
35.0	0.56	0.56	0.62	25.80	25.18	25.18	25.41	24.80	24.72
36.0	0.66	0.67	0.74	21.81	20.98	20.70	21.53	20.78	20.48
37.0	0.83	0.86	0.95	17.16	16.39	16.04	17.10	16.37	15.99
38.0	1.14	1.21	1.33	12.70	12.04	11.72	12.76	12.12	11.76
39.0	1.77	1.88	2.06	8.78	8.29	8.04	8.89	8.38	8.10
40.0	2.89	3.09	3.33	5.68	5.34	5.17	5.77	5.41	5.24
41.0	4.65	4.93	5.24	3.47	3.26	3.18	3.56	3.35	3.26
42.0	7.03	7.37	7.70	2.08	1.98	1.96	2.16	2.05	2.02
43.0	9.84	10.19	10.55	1.28	1.24	1.26	1.35	1.30	1.30
44.0	12.87	13.21	13.57	0.85	0.83	0.87	0.90	0.88	0.91
45.0	15.99	16.33	16.70	0.60	0.60	0.64	0.65	0.64	0.67
46.0	19.14	19.44	19.79	0.46	0.47	0.51	0.49	0.50	0.53
47.0	22.26	22.58	22.96	0.36	0.38	0.42	0.39	0.41	0.43
48.0	25.40	25.73	26.07	0.30	0.32	0.35	0.32	0.33	0.36
49.0	28.57	28.88	29.24	0.27	0.28	0.32	0.28	0.30	0.32
50.0	31.79	32.14	32.47	0.23	0.24	0.28	0.25	0.26	0.29
51.0	35.07	35.46	35.79	0.20	0.22	0.25	0.22	0.24	0.25
52.0	38.48	38.83	39.25	0.18	0.20	0.23	0.20	0.22	0.23
53.0	42.06	42.49	42.95	0.16	0.18	0.21	0.18	0.19	0.21
53.5	43.95	44.46	44.73	0.16	0.17	0.21	0.17	0.19	0.21
54.0	45.92	46.42	46.82	0.16	0.17	0.20	0.17	0.19	0.20
55.0	50.17	50.86	51.26	0.15	0.17	0.19	0.16	0.17	0.19
56.0	55.17	55.95	56.69	0.14	0.15	0.18	0.14	0.16	0.18
57.0	61.48	63.07	63.90	0.12	0.14	0.17	0.13	0.14	0.16
58.0	73.85	76.14	79.18	0.12	0.13	0.16	0.12	0.14	0.16
59.0	73.70	70.60	71.83	0.11	0.13	0.15	0.12	0.14	0.15
60.0	68.56	67.77	67.00	0.10	0.12	0.15	0.11	0.13	0.14
62.0	65.88	65.24	65.08	0.10	0.12	0.14	0.11	0.13	0.13
64.0	65.82	65.86	66.16	0.10	0.11	0.13	0.10	0.12	0.13
65.0	67.51	68.06	68.33	0.10	0.11	0.13	0.11	0.12	0.13
70.0	78.87	81.48	78.01	0.08	0.10	0.11	0.08	0.10	0.11
75.0	68.76	68.26	67.04	0.08	0.10	0.10	0.08	0.10	0.10
80.0	65.34	65.35	64.30	0.08	0.10	0.11	0.08	0.09	0.10
90.0	63.88	64.03	64.01	0.08	0.09	0.11	0.07	0.08	0.09
100.0	64.18	65.47	64.77	0.07	0.09	0.11	0.07	0.09	0.10
200.0	56.94	58.10	57.73	0.12	0.13	0.14	0.09	0.10	0.11
250.0	54.79	55.77	55.59	0.13	0.15	0.16	0.10	0.11	0.12
390.0	50.71	49.78	49.59	0.15	0.17	0.21	0.14	0.17	0.18
400.0	46.47	45.87	45.42	0.16	0.18	0.23	0.14	0.16	0.18
410.0	42.33	41.92	41.52	0.18	0.21	0.25	0.16	0.19	0.20
475.0	36.39	36.95	36.88	0.19	0.21	0.26	0.17	0.21	0.21
600.0	55.61	58.60	57.35	0.27	0.30	0.35	0.22	0.25	0.27
700.0	10.62	10.74	10.73	3.77	3.64	3.68	2.14	2.22	2.28
800.0	16.66	16.90	16.93	0.45	0.49	0.53	0.50	0.54	0.57
900.0	21.58	21.80	21.70	0.23	0.28	0.33	0.23	0.28	0.30
1000.0	22.59	22.89	22.75	0.19	0.25	0.31	0.17	0.23	0.26

REV. X2  
SCLF-36+  
101110  
Page 1 of 2



IF/RF MICROWAVE COMPONENTS • ISO 9001 ISO 14001 AS 9100 CERTIFIED • RoHS compliant  
P.O. Box 350166, Brooklyn, New York 11235-0003 (718) 934-4500 Fax (718) 332-4661



The Design Engineers Search Engine finds the model you need, Instantly • For detailed performance specs & shopping online see



# Surface Mount Low Pass Filter

# SCLF-36+

## Typical Performance Data

FREQ. (MHz)	GROUP DELAY (nsec)		
	@ -40° C	@ +25° C	@ +85° C
0.1	14.96	15.66	17.52
1	15.93	16.10	15.91
2	15.71	15.70	16.19
3	15.82	15.75	15.78
4	15.89	16.06	15.91
5	16.35	16.08	16.17
6	16.21	16.37	16.19
7	16.25	16.58	16.15
8	16.44	16.22	16.37
9	16.50	16.42	16.25
10	16.65	16.54	16.64
11	16.65	16.52	16.74
12	16.74	16.54	16.93
13	16.90	17.13	17.29
14	17.20	16.88	17.12
15	17.21	17.39	17.32
16	18.05	18.29	18.25
17	18.36	18.28	18.30
18	18.57	18.69	18.59
19	18.87	19.10	19.02
20	19.36	19.68	19.34
21	19.85	19.61	19.84
22	20.31	20.30	20.52
23	20.77	20.95	20.97
24	21.24	21.25	21.26
25	21.89	21.91	22.16
26	22.68	22.75	22.70
27	23.47	23.62	23.59
28	24.70	24.69	24.83
29	25.42	25.61	25.75
30	27.02	27.11	27.14
31	28.13	28.35	28.54
32	30.00	29.93	30.10
33	31.70	31.94	32.24
34	34.07	34.55	34.77
35	36.97	37.30	37.82
36	41.15	41.47	41.73
37	46.70	46.68	47.33
38	52.45	52.77	53.14
39	58.21	58.42	58.75
40	61.54	60.92	60.64
41	59.36	58.54	57.72
42	52.66	51.59	50.96
43	44.61	43.66	43.20
44	36.89	36.48	35.91
45	31.06	30.36	30.55
46	25.84	26.28	25.59
47	22.82	21.97	21.95
48	19.49	19.37	19.25
49	16.59	16.83	17.07
50	14.55	14.54	14.85
52	12.44	11.01	10.95
53	11.19	11.68	9.11
54	8.09	10.30	7.83
55	5.30	9.15	10.13

REV. X2  
SCLF-36+  
101110  
Page 2 of 2



IF/RF MICROWAVE COMPONENTS • ISO 9001 ISO 14001 AS 9100 CERTIFIED • RoHS compliant  
P.O. Box 350166, Brooklyn, New York 11235-0003 (718) 934-4500 Fax (718) 332-4661



The Design Engineers Search Engine finds the model you need, Instantly • For detailed performance specs & shopping online see



## Typical Performance Curves

### INSERTION LOSS vs. TEMPERATURE

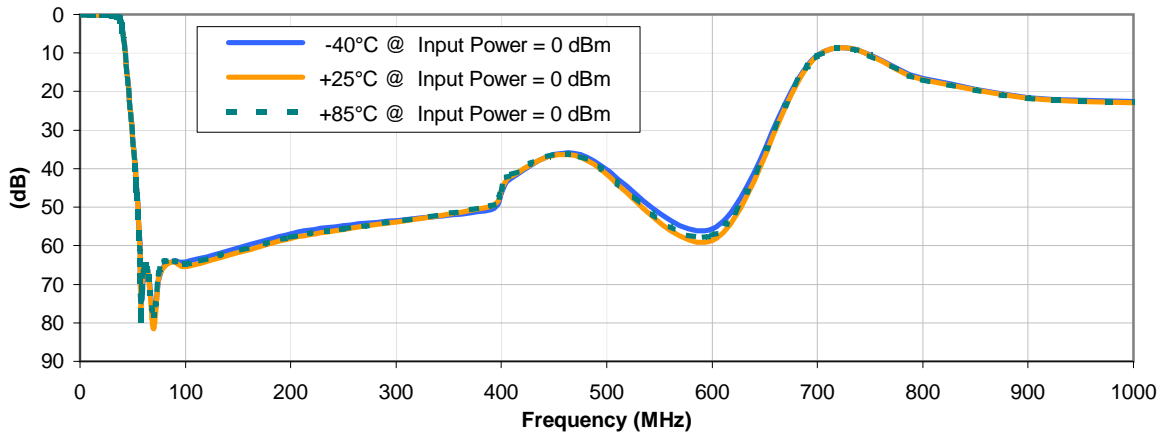

### INPUT RETURN LOSS vs. TEMPERATURE

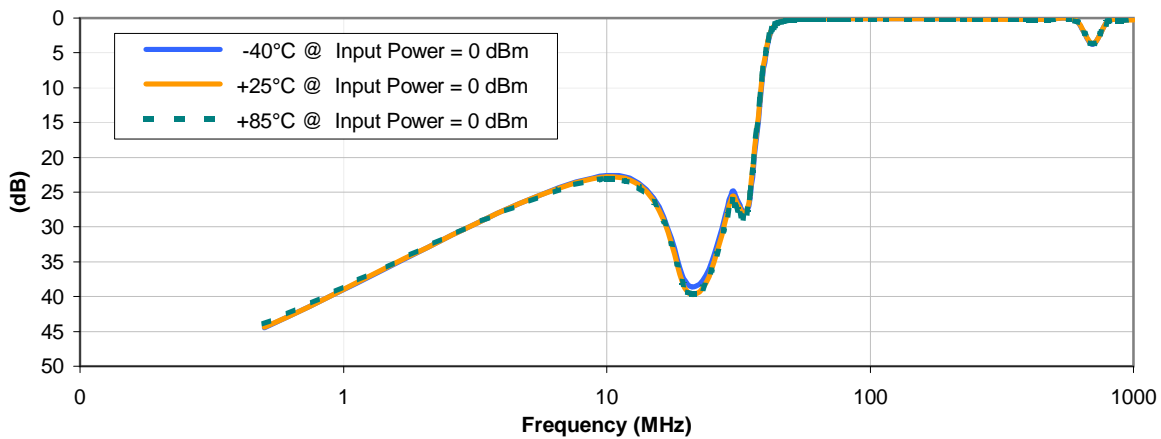

### OUTPUT RETURN LOSS vs. TEMPERATURE

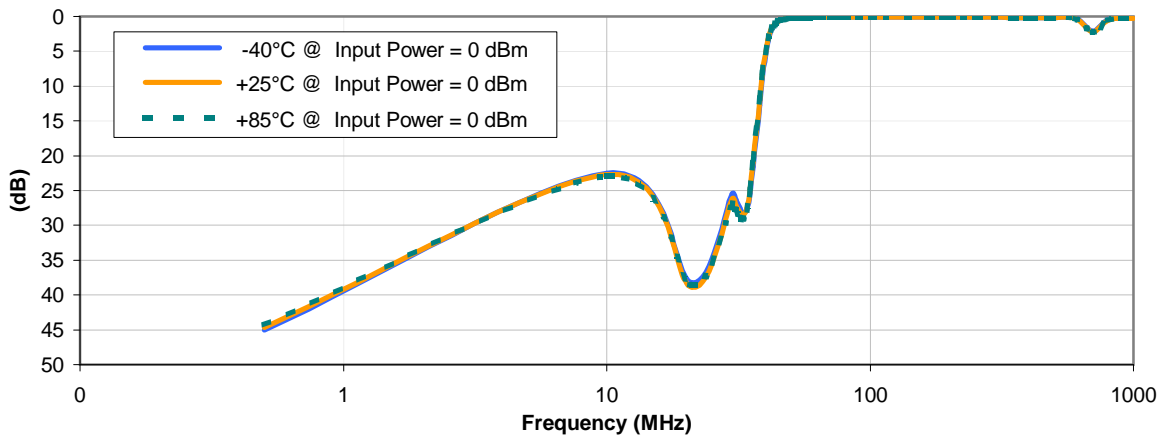

## Typical Performance Curves

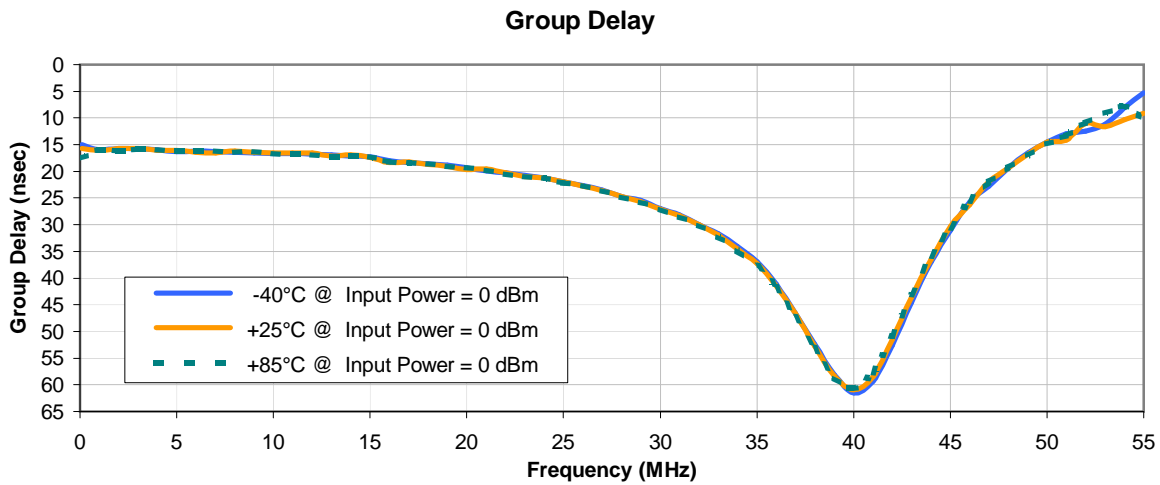

## Outline Dimensions

YY101  
YY109  
YY161

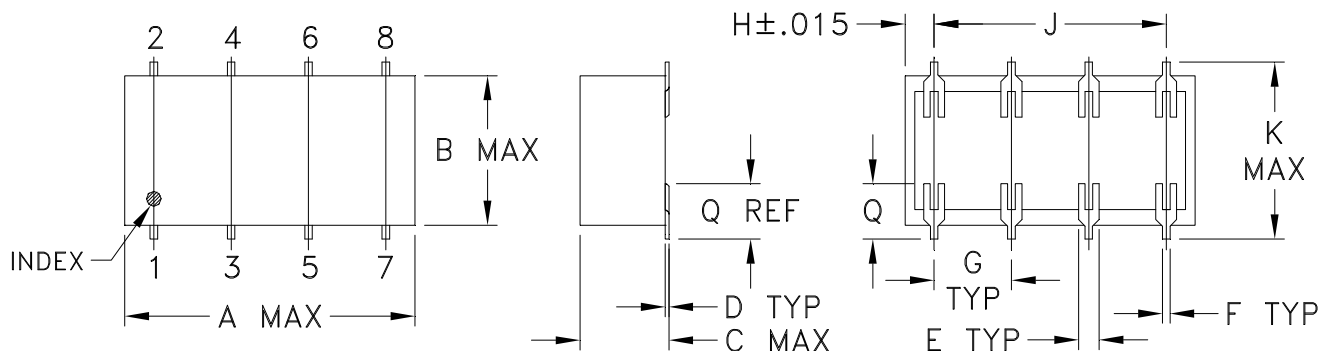

## PCB Land Pattern

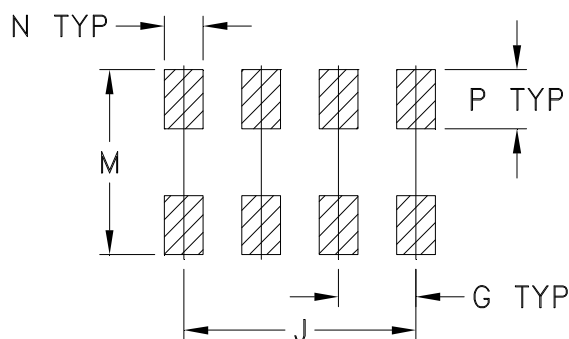

Suggested Layout  
Tolerance to be within  $\pm .002$

CASE#	A	B	C	D	E	F	G	H	J	K	L	M	N	P	Q	WT. GRAMS
YY101*			.20 (5.08)							.450 (11.43)	-- (11.94)	.470 (11.94)				1.6
YY109*	.75 (19.05)	.38 (9.65)	.20 (5.08)	.010 (0.25)	.050 (1.27)	.020 (0.51)	.200 (5.08)	.075 (1.91)	.600 (15.24)	.720 (18.29)	-- (18.80)	.740 (18.80)	.100 (2.54)	.150 (3.81)	.148 (3.76)	1.6
YY161			.28 (7.11)							.450 (11.43)	-- (11.94)	.470 (11.94)				1.6

Dimensions are in inches (mm). Tolerances: 2 Pl.  $\pm .01$ ; 3 Pl.  $\pm .005$

### Notes:

- Case material: Plastic.
- Termination finish:  
For RoHS Case Styles: Tin plate over Nickel plate.  
For RoHS-5 Case Styles: Tin-Lead plate.
- Special Tolerances: Termination thickness  $\pm .003$  inch.
- \* Denotes: For SCM mixers, long termination version (case YY109) is available upon request, consult factory. To order short termination version (case YY101) add -NL suffix.

# Tape & Reel Packaging TR-F5



Tape Width, mm	Device Cavity Pitch, mm	Reel Size, inches	Devices per Reel
32	16	13	500

Mini-Circuits carrier tape materials provide protection from ESD (Electro-Static Discharge) during handling and transportation. Tapes are static dissipative and comply with industry standards EIA-481/EIA-541.

Go to: [www.minicircuits.com/pages/pdfs/tape.pdf](http://www.minicircuits.com/pages/pdfs/tape.pdf)



**Distribution Centers** NORTH AMERICA 800-654-7949 • 417-335-5935 • Fax 417-335-5945 • EUROPE 44-1252-832600 • Fax 44-1252-837010

Mini-Circuits ISO 9001 & ISO 14001 Certified

INTERNET <http://www.minicircuits.com>

P.O. Box 350166, Brooklyn, New York 11235-0003 (718) 934-4500 Fax (718) 332-4661

THIRD ANGLE PROJECTION

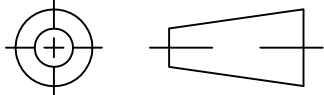

REVISIONS

REV	ECN No.	DESCRIPTION	DATE	DR	AUTH
OR	M81561	NEW RELEASE	09/11/02	GF	ABD
A	M101145	ADDED YY101 CASE STYLE & NOTE 2	10/07/05	MMG	ABD
B	M102713	ADDED "...WITH SMOBC"	01/16/06	GT	IL
C	M165986	TB-187+ (WAS TB-187)	02/01/18	ITG	IL

SUGGESTED MOUNTING CONFIGURATION FOR YY101/YY161 CASE STYLE, "cr" PIN CONNECTION

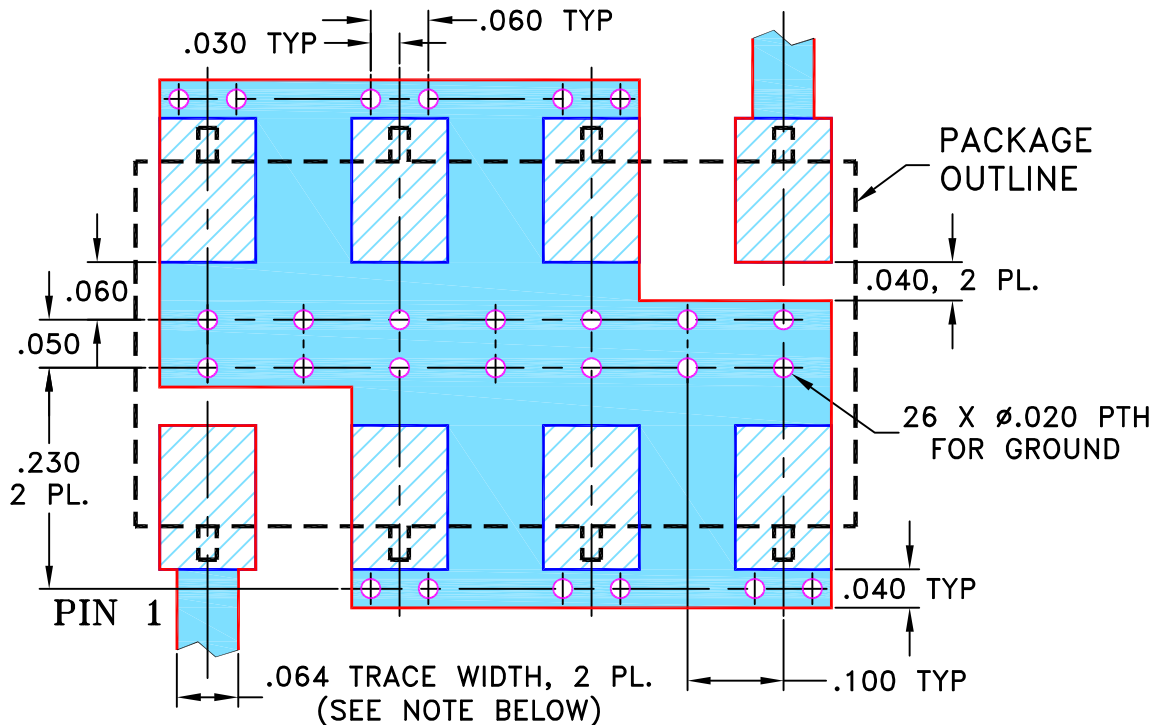

- NOTES:**
- TRACE WIDTH IS SHOWN FOR ROGERS R04350B WITH DIELECTRIC THICKNESS .030" ± .002"; COPPER: 1/2 OZ. EACH SIDE. FOR OTHER MATERIALS TRACE WIDTH MAY NEED TO BE MODIFIED.
  - BOTTOM SIDE OF THE PCB IS CONTINUOUS GROUND PLANE.



DENOTES PCB COPPER LAYOUT WITH SMOBC (SOLDER MASK OVER BARE COPPER)



DENOTES COPPER LAND PATTERN FREE OF SOLDER MASK

UNLESS OTHERWISE SPECIFIED	INITIALS		DATE
DIMENSIONS ARE IN INCHES	DRAWN	GF	08/12/02
TOLERANCES ON:	CHECKED	AV	09/11/02
2 PL DECIMALS ±	APPROVED	ABD	09/11/02
3 PL DECIMALS ± .005			
ANGLES ±			
FRACTIONS ±			



**Mini-Circuits®** 13 Neptune Avenue  
Brooklyn NY 11235

PL, cr, YY101/YY161, SCLF, TB-187+

SIZE	CODE IDENT	DRAWING NO:	REV:
A	15542	98-PL-049	C
FILE:	98PL049	SCALE:	5:1
		SHEET:	1 OF 1

Mini-Circuits®  
THIS DOCUMENT AND ITS CONTENTS ARE THE PROPERTY OF MINI-CIRCUITS. EXCEPT FOR USE EXPRESSLY GRANTED, IN WRITING, TO ITS VENDORS, VENDEE AND THE UNITED STATES GOVERNMENT, MINI-CIRCUITS RESERVES ALL PROPRIETARY DESIGN, USE, MANUFACTURING AND REPRODUCTION RIGHTS THERETO. THESE CONTENTS SHALL NOT BE USED, DUPLICATED OR DISCLOSED TO ANY OUTSIDE PARTY, IN WHOLE OR IN PART, WITHOUT WRITTEN PERMISSION OF MINI-CIRCUITS.



# Evaluation Board and Circuit

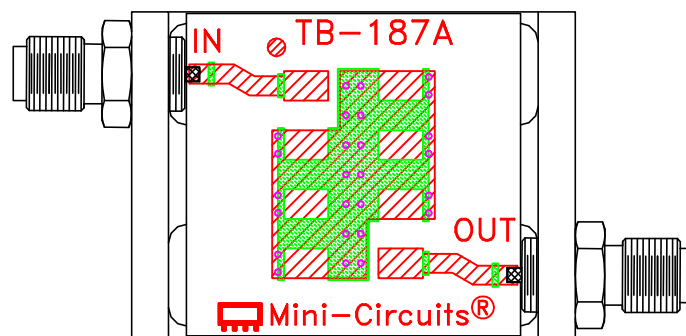

TB-187+

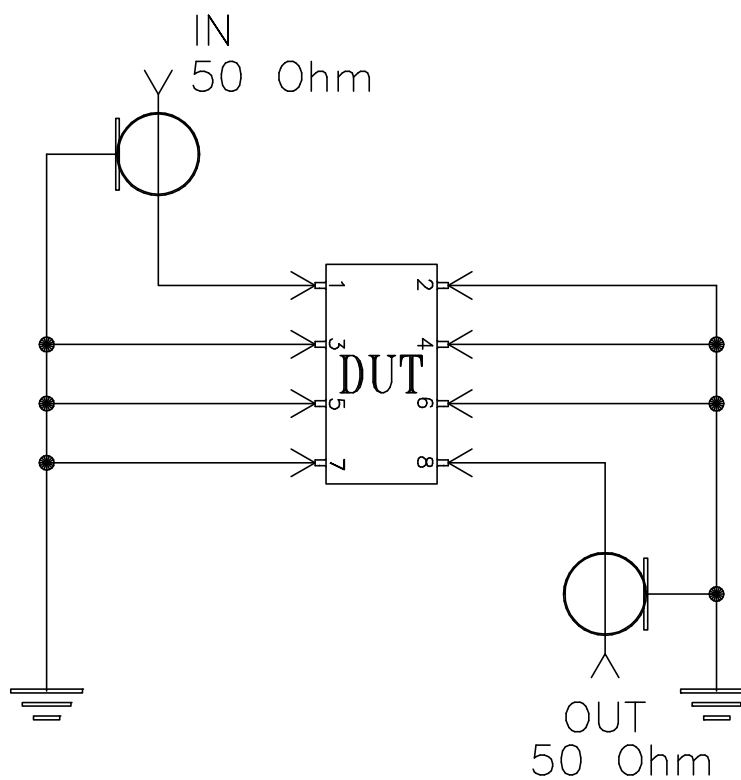

Schematic Diagram

## Notes:

1. SMA Female connectors.
2. PCB Material: Rogers R04350 or equivalent,  
Dielectric Constant=3.5, Thickness=.030 inch.

 **Mini-Circuits®**



All Mini-Circuits products are manufactured under exacting quality assurance and control standards, and are capable of meeting published specifications after being subjected to any or all of the following physical and environmental test.

Specification	Test/Inspection Condition	Reference/Spec
Operating Temperature	-40° to 85°C Ambient Environment	Individual Model Data Sheet
Storage Temperature	-55° to 100° C Ambient Environment	Individual Model Data Sheet
Humidity	90 to 95% RH, 240 hours, 50°C	MIL-STD-202, Method 103, Condition A, Except 50°C and end-point electrical test done within 12 hours
Thermal Shock	-55° to 100°C, 100 cycles	MIL-STD-202, Method 107, Condition A-3, except +100°C
Solder Reflow Heat	Sn-Pb Eutetic Process: 225°C peak Pb-Free Process 245° - 250°C peak	J-STD-020, Table 4-1, 4-2 and 5-2, Figure 5-1
Solderability	10X Magnification	J-STD-002, 95% Coverage
Vibration (High Frequency)	20g peak, 10-2000 Hz, 12 times in each of three perpendicular directions (total 36)	MIL-STD-202, Method 204, Condition D
Mechanical Shock	50g, 11 ms, 1/2-sine, 18 shocks: 3 each direction, each of 3 axes	MIL-STD-202, Method 213, Condition A
Marking Resistance to Solvents	Isopropyl alcohol + mineral spirits at 25°C; terpene defluxer at 25°C; distilled water + proylene glycol monomethyl ether + monoethanolamine at 63°C to 70°C	MIL-STD-202, Method 215