

R516 series: the RAMSES concept merges with the SLIM LINE technology, breaking up the frequency limits of SMT switches :

- FULL SMT TECHNOLOGY COMPATIBLE
- High frequency
- High life span
- High repeatability
- High power applications

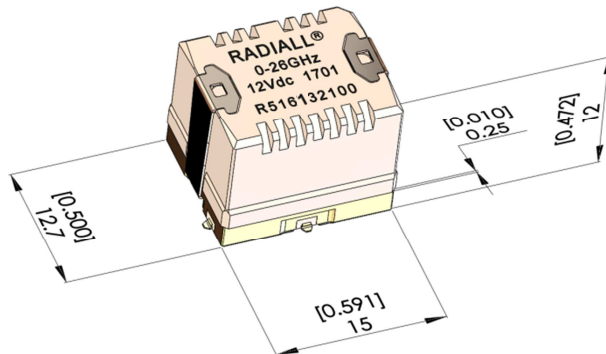

(All dimensions are in mm [inches])

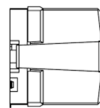
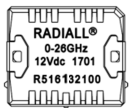
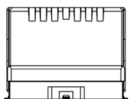

ACTUAL SIZE

TYPICAL OUTLINE DRAWING

PART NUMBER SELECTION

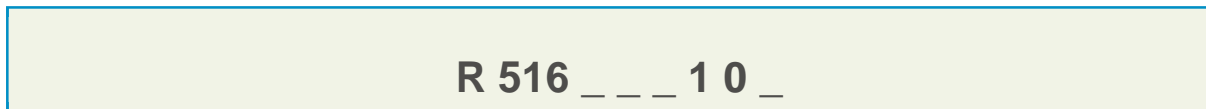

Frequency range :
 3 : DC – 8GHz
 4 : DC – 18GHz
 7 : DC – 26.5GHz

TYPE :
 1 : Failsafe
 9 : Failsafe, inverted RF path (1)

ACTUATOR VOLTAGE (3) :
 2 : 12Vdc
 3 : 24Vdc

Actuator terminals :
 0 : Not soldered
 T : Soldered on a connectorized test fixture (2)

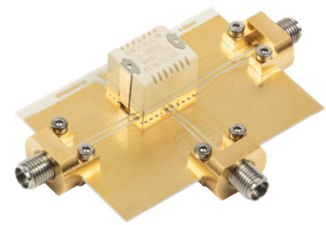

(1): Can be combined with a failsafe model, so as to achieve the "BYPASS" function (see application details on page 5)
 (2): See details about test fixture dimensions on page 3
 (3): 6V version available upon request

GENERAL SPECIFICATION

Operating mode		Failsafe (Type 1 & 9)		
Nominal operating voltage (Vdc) (1) (across operating temperature range)		6 (1) (5.3 to 6.6)	12 (10.5 to 13)	24 (21.5 to 30)
Coil resistance (+/-10%) (Ohms)		49	195	710
Operating current at 23°C (mA)		123	61	34
RF and command ports		gold plated access, infrared reflow, forced air oven or hand soldering (Compatible with "lead free" soldering processes)		
Switching time (Nomial voltage)	Making contacts	Max 5ms, including contact bounce time		
	Breaking contacts	3ms		
Life	Cold switching (Max 120 cycles/min)	1 million cycles		
	Hot switching (Max 20 cycles/min)	500.000 cycles (1W, impedance 50Ω , V.S.W.R. <1.25)		
Insulation		Dielectric test voltage	300Vrms	
		Insulation resistance at 500Vdc	> 100MOhms	
Environmental protection		"LEAD FREE » construction" Waterproofness according to IEC 60529 / IP64		
Mass		7.5g		
Operating temperature range (°C) (With no icing nor condensation)		-25 to +70 (2)		
Storage temperature range (°C)		-55 to +85		
Shocks (According to MIL STD 202, method 213B, Cond C)		100g / 6ms, ½ sine No change of state		
Sine vibration (MIL STD 202, method 204)		Condition D : 10-2000Hz, 20g Operating Condition G : 10-2000Hz, 30g Non operating		

(1) : 6V version available upon request

(2) : If coil remains permanently supplied under -25°C, internal condensation may occur and generate contact failures. For such special applications from -25°C to -40°C, please contact us.

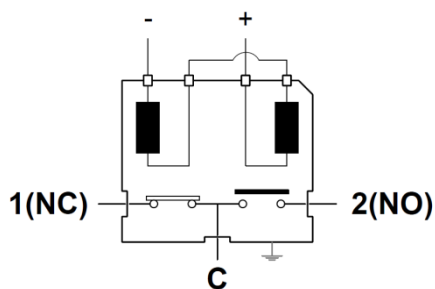
PIN IDENTIFICATION (TOP VIEW)

**Failsafe model
(Type 1)**

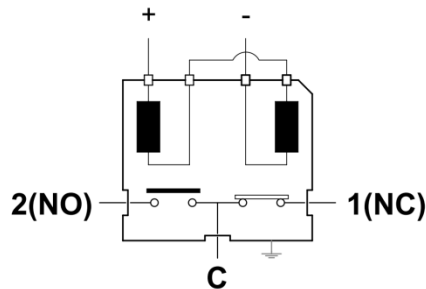
Voltage	RF Continuity
De-energized	C ↔ 1 (NC)
Energized	C ↔ 2 (NO)

**Inverted Failsafe model for Bypass
application (type 9)**

Voltage	RF Continuity
De-energized	C ↔ 1 (NC)
Energized	C ↔ 2 (NO)

RF PERFORMANCES (1)

Frequency Range (GHz)		V.S.W.R	IL	Isolation	Average power W	Third order Inter modulation	Impedance
		(max)	(max) dB	(min) dB	hot switching		Ohms
DC – 8 DC – 18 DC – 26.5	DC – 3	1.20	0.20	50	40	-110 dBc Typical @ 1730 MHz (2 carriers 20W)	50
	3 – 6	1.35	0.40	40	25		
	6 – 8	1.40	0.50	40	5		
	8 – 12.4	1.50	0.60	40	3		
	12.4 – 18	1.70	1.00	40	1		
	18 – 26.5	2.00	1.60	40	1		

(1) : at high frequency, manual soldering may generate spikes and RF characteristics degradation, due to air gaps between PC board and relay ground.

TYPICAL RF PERFORMANCE - MEASUREMENT METHOD USING **UOSM 2.92mm CALIBRATION** (2)

Inputs/Outputs of the calibration board and test fixture are equipped with coaxial type receptacle connectors. The length of the RF tracks is the same on the calibration board and the test fixture circuits. The insertion loss of the relay itself is calculated by subtracting the insertion loss of the "calibration board" to the insertion loss of the "relay welded on the test fixture".

(2): Relay soldered on Test Fixture is available. To order, please use the suffix "T" (part number R516 - - - - T), as explained in page 1.

Relay soldered on test fixture (2)

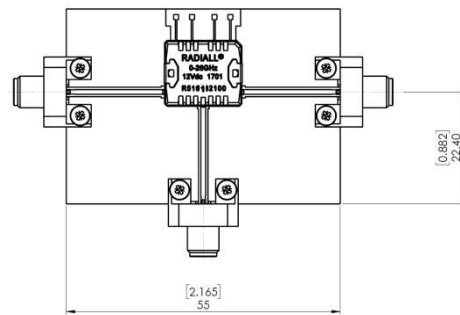

Calibration board

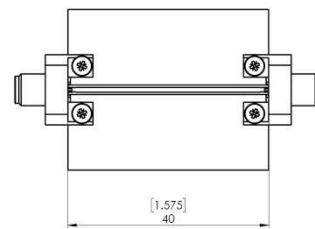

All dimensions are in millimeters [inches]

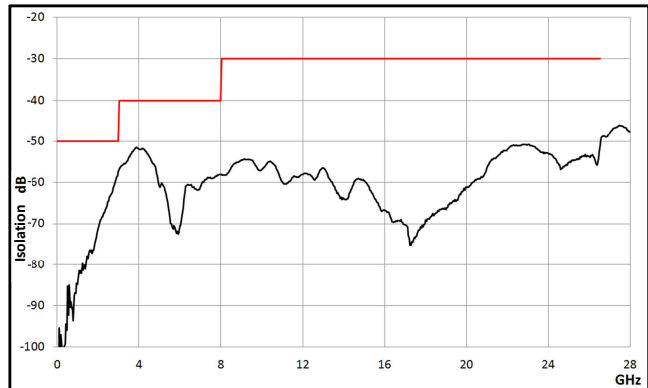
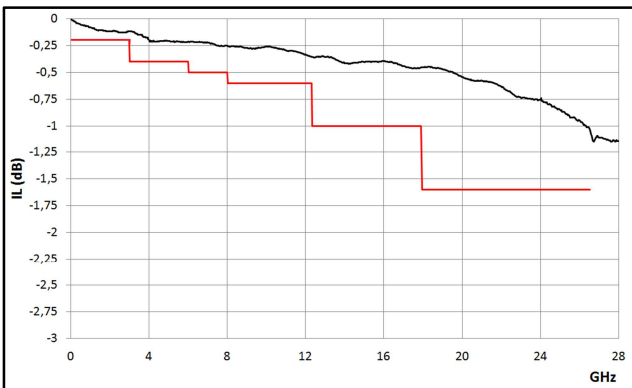
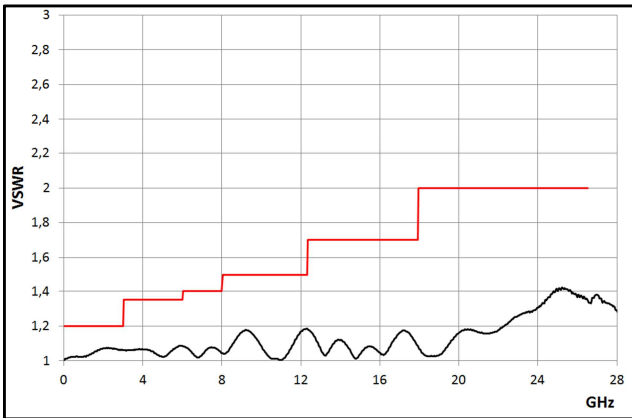

PAGE 4/6	ISSUE 28-01-19	SERIES Micro-SPDT	PART NUMBER R516 XXX 10X
----------	----------------	-------------------	--------------------------

RF POWER RATING FOR COLD SWITCHING USE
 (Impedance 50 Ohms, V.S.W.R. < 1.25)

Power level depends on environmental conditions :

- R516 series have been designed to be used without a cooling fan even for high power applications. However, the power capability may be still improved by using the appropriate cooling fan.
- For failsafe models used with coil permanently supplied (N/O position), the same power level as latching models may be applied.

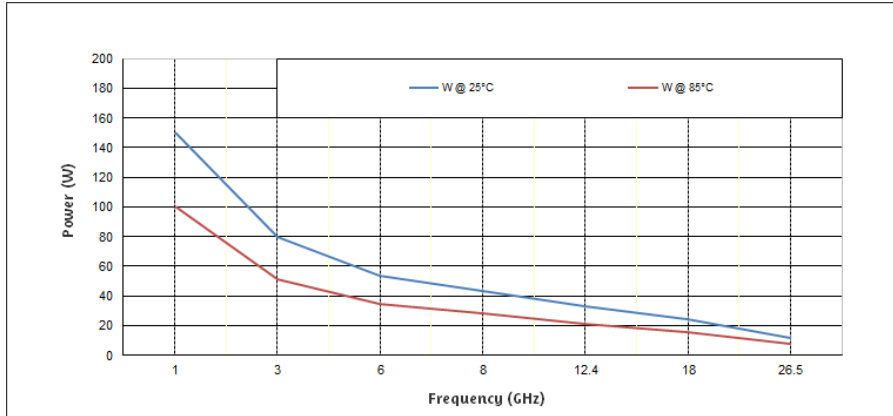

RELAY PACKAGING

According to IEC 286-3 standard

- For quantities up to 50 relays: packaged in tape without reel
- For upper quantities: packaged in tape and reel, maximum **200** relays per reel

MATERIALS

- Reel : polyester
- Carrier tape : PVC
- Cover tape : polyester

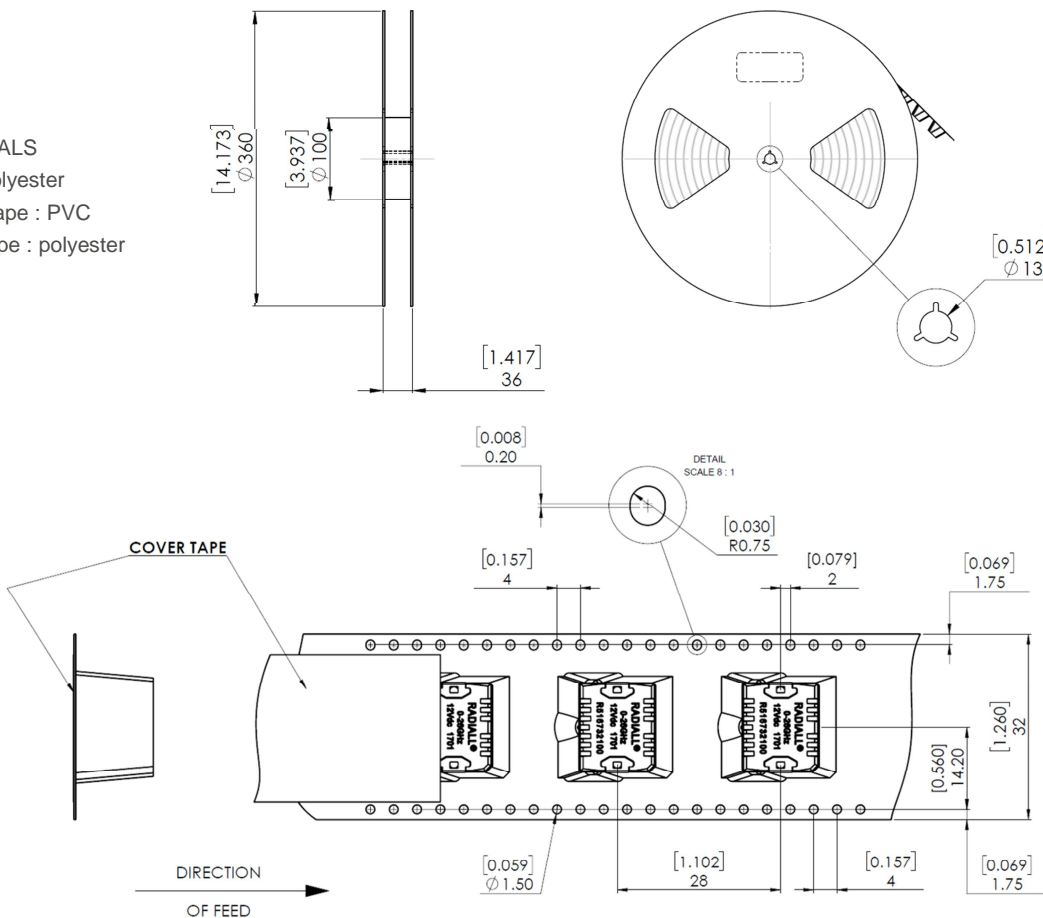

Video shadow of the relay

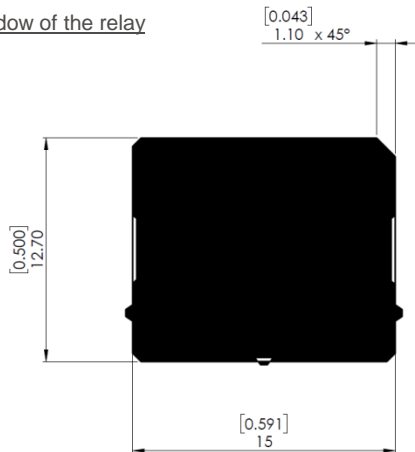

Aspiration area

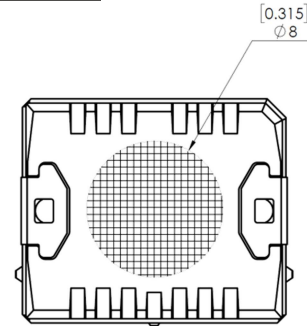

All dimensions are in millimeters [inches].

BYPASS APPLICATION

Failsafe Micro-relay typical implantation

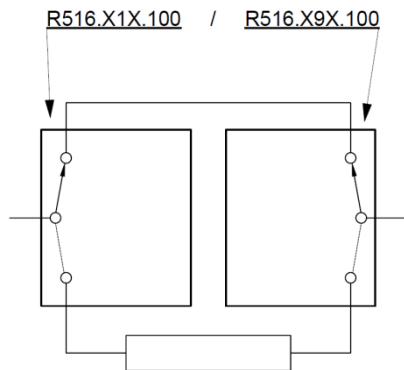

SPDT relays (Single Pole Double Throw) can be used to achieve a bypass switch function. For SMT applications, R516 series, relays are available in two failsafe versions, standard and inverted, to provide symmetric RF ports implantation possibility. The “side by side” implementation of these two versions on a PCB effectively produces the bypass function. The package size is reduced and interconnecting tracks are shortened. Required in order to protect the receiver for transmit/receive applications. RF performances of bypass switch assemblies depend on the distance between the two RF SMT relays.
DXF or GERBER format file available upon request.

PC BOARD MOUNTING

Substrate Types

Recommended substrates are ROGERS RO4003., Thickness 0.508 mm Cu double side 17.5µm. Recommended total thickness of RF tracks (copper over thickness + plating) : 40µm.

Other substrates may be used (1)

Board layout general outline

DXF or GERBER format file available upon request (1)

Relay soldering

DXF format file available upon request (1)

Optionnal fixing system : 2 screws M1.2 (see details on page 7 / B-4)

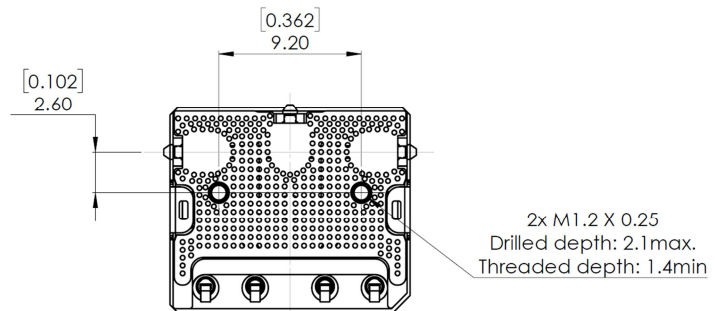
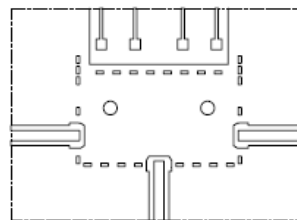

(1) : Please contact us by E-mail : switchingproducts@radiall.com

RECOMMENDED SOLDERING PROCEDURE

A – Soldering procedure using automatic pick and place equipment

1-Solder paste :

R516 series are « Lead Free », and Lead Free Sn-Ag3.5-Cu0.7 solder cream may be used as well as standard Sn63–Pb35–Ag2. RADIALL recommends using a « no clean - low residue » solder cream (5% solid residue of flux quantity) that will permit the elimination of the cleaning operation step after soldering.
 Note : Due to the gold plating of the switch PCB interface, it is important to use a paste made with silver. This will help in avoiding formation of intermetallics as part of the solder joint.

2-Solder paste deposition :

Solder cream may be applied on the board with screen printing or dispenser technologies. For either method, the solder paste must be coated to appropriate thickness and shapes to achieve good solder wetting. Please optically verify that the edges of the zone are clean and without contaminates, and that the PCB zoned areas have not oxydated. The design of the mounting pads and the stenciling area are available upon request, for a thickness of the silk-screen printing of **0.15 mm (0.006 ”)**.

3-Placement of the component :

For small lightweight components such as chip components, a self-alignment effect can be expected if small placement errors exist. However, this effect is not as expected for relays components and they require a accurate positioning on their soldering pads, typically +/- 0.1mm (+/-0.004”).
 Place the relay onto the PCB with automatic pick and place equipment. Various types of suction can be used.
 RADIALL does not recommend using adhesive agents on the component or on the PCB.

4-Soldering : infra-red process

Please follow the RADIALL recommended max temperature profile for infra-red reflow or forced air convection :

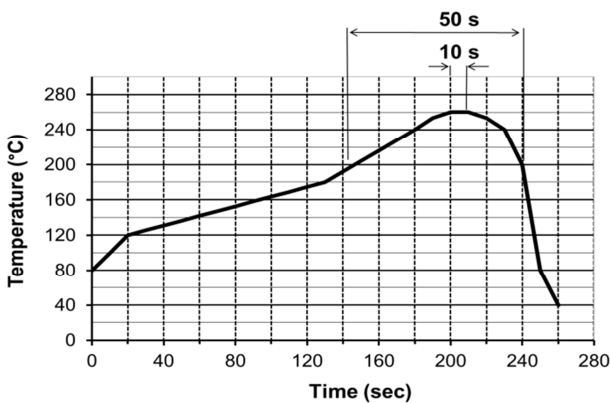

Higher temperature (>260°C) and longer process duration would damage permanently the switches.

5-Cleaning procedure :

On miniature relays, high frequency cleaning may cause the contacts to stick. If cleaning is needed, please avoid ultrasonic cleaning and use alcohol based cleaning solutions.



In-line cleaning process, spraying, immersion, especially under temperature, may cause a risk of degradation of internal contacts. For such cleaning process please contact us.

6-Quality check :

Verify by visual inspection that the component is centred on the mounting pads.
 Solder joints : verify by visual inspection that the formation of meniscus on the pads are proper.

B – Soldering procedure by manual operation



: manual soldering is not recommended for high frequencies, as it generates resonance and lower RF characteristics due to gaps between PC board and relay grounds,.

1-Solder paste and flux deposition :

Refer to procedure A – 1
 Deposit a thin layer of flux on solder paste area.
 Allow the flux to evaporate a few seconds before applying the solder paste, this will prevent dilution of the paste.

2-Solder paste deposition :

RADIALL recommends depositing a small amount of solder paste on solder pad area by syringe, according to the manual soldering pattern (available upon request).
 Be careful, not to apply solder paste outside of the zone area.

3-Placement of the component :

During manipulation, avoid contaminating gold surfaces by contact with fingers.
 Place the component on the mounting zone by pressing on the top of the relay lid.

4-Hand soldering :

Iron wattage 30 to 60 W.
 To keep better RF characteristics, apply pressure on the relay lid during all the soldering stage, so as to reduce the air gap between the PC board and the relay.
 If possible, fix the ground plane of the relay on the board with two M1.2 screws before the soldering stage. On each side of the central RF access, the RF body edge must be soldered to the ground of the PC board. To improve RF characteristics and avoid soldering the RF body on the ground, a conductive gasket may be used (please contact us for detailed application note).

5-Cleaning procedure :

Refer to procedure A – 5.

6-Quality check:

Verify by visual inspection that component is centred on the mounting pads.
 Solder joints : verify by visual inspection that there is no solder excess on the RF pads.