

GENERAL DESCRIPTION

The SGM432x is a precision programmable shunt voltage reference that can be used in many applications. It is a three-terminal adjustable-output device that can keep stable under all capacitive loads. It requires two external capacitors in application to set the output voltage is to any value between V_{REF} and 36V. All versions have a maximum operating current of 100mA.

The SGM432x features low dynamic impedance, low noise, and low temperature coefficient to ensure a stable output voltage over a wide range of operating temperatures and currents. These high performances make it very suitable for multiple applications, such as precision audio components and flyback switching power supplies.

The SGM432x is available in Green SOT-89-3, SOT-23 and SOT-23-5 packages.

FEATURES

- **Adjustable Output Voltage:** V_{REF} to 36V
- **Sink-Current Capability:** 1mA to 100mA
- **Reference Voltage Tolerance at +25°C:**
 - ◆ SGM432: 1% (Standard Grade)
 - ◆ SGM432B: 0.5% (B Grade)
- **Output Impedance:** 0.1Ω (TYP)
- **Temperature Drift:** 5mV (TYP)
- **High Stability under Capacitive Load**
- **Low Output Noise**
- **-40°C to +125°C Operating Temperature Range**
- **Available in Green SOT-89-3, SOT-23 and SOT-23-5 Packages**

APPLICATIONS

- Portable, Battery-Powered Equipment
- Voltage Monitoring
- Flyback Switching Power Supplies
- Instrumentation
- Product Testing
- Precision Audio Components

TYPICAL APPLICATION

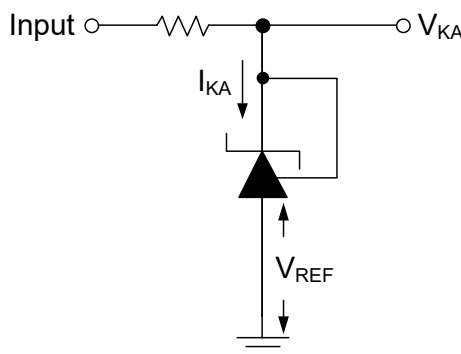

Figure 1. Typical Application Circuit

PACKAGE/ORDERING INFORMATION

MODEL	PACKAGE DESCRIPTION	SPECIFIED TEMPERATURE RANGE	ORDERING NUMBER	PACKAGE MARKING	PACKING OPTION
SGM432	SOT-89-3	-40°C to +125°C	SGM432XK3G/TR	SGM432X XXXXX	Tape and Reel, 1000
	SOT-23	-40°C to +125°C	SGM432XN3LG/TR	CB7XX	Tape and Reel, 3000
	SOT-23-5	-40°C to +125°C	SGM432XN5G/TR	CJCXX	Tape and Reel, 3000
SGM432B	SOT-89-3	-40°C to +125°C	SGM432BXK3G/TR	SGM432BX XXXXX	Tape and Reel, 1000
	SOT-23	-40°C to +125°C	SGM432BXN3LG/TR	CYBXX	Tape and Reel, 3000
	SOT-23-5	-40°C to +125°C	SGM432BXN5G/TR	CY9XX	Tape and Reel, 3000

MARKING INFORMATION

NOTE: XX = Date Code, XXXXX = Date Code, Trace Code and Vendor Code.

SOT-23/SOT-23-5

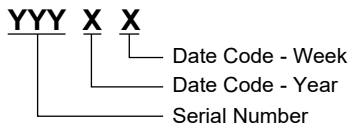

SOT-89-3

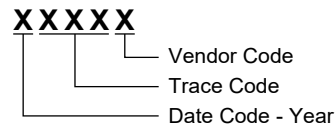

Green (RoHS & HSF): SG Micro Corp defines "Green" to mean Pb-Free (RoHS compatible) and free of halogen substances. If you have additional comments or questions, please contact your SGMICRO representative directly.

ABSOLUTE MAXIMUM RATINGS

- Cathode Voltage ⁽¹⁾, V_{KA}..... 40V
- Package Thermal Resistance
- SOT-89-3, θ_{JA} 71°C/W
- SOT-23, θ_{JA}..... 245°C/W
- SOT-23-5, θ_{JA} 210°C/W
- Junction Temperature+150°C
- Storage Temperature Range.....-65°C to +150°C
- Lead Temperature (Soldering, 10s)+260°C
- ESD Susceptibility
- HBM..... 4000V
- CDM 1000V

RECOMMENDED OPERATING CONDITIONS

- Cathode Voltage, V_{KA} V_{REF} to 36V
- Cathode Current, I_{KA}.....1mA to 100mA
- Operating Junction Temperature Range-40°C to +125°C

NOTE:

1. All voltage values are with respect to ANODE, unless otherwise noted.

OVERSTRESS CAUTION

Stresses beyond those listed in Absolute Maximum Ratings may cause permanent damage to the device. Exposure to absolute maximum rating conditions for extended periods may affect reliability. Functional operation of the device at any conditions beyond those indicated in the Recommended Operating Conditions section is not implied.

ESD SENSITIVITY CAUTION

This integrated circuit can be damaged if ESD protections are not considered carefully. SGMICRO recommends that all integrated circuits be handled with appropriate precautions. Failure to observe proper handling and installation procedures can cause damage. ESD damage can range from subtle performance degradation to complete device failure. Precision integrated circuits may be more susceptible to damage because even small parametric changes could cause the device not to meet the published specifications.

DISCLAIMER

SG Micro Corp reserves the right to make any change in circuit design, or specifications without prior notice.

PIN CONFIGURATIONS

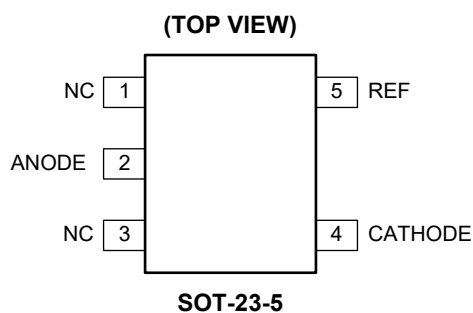
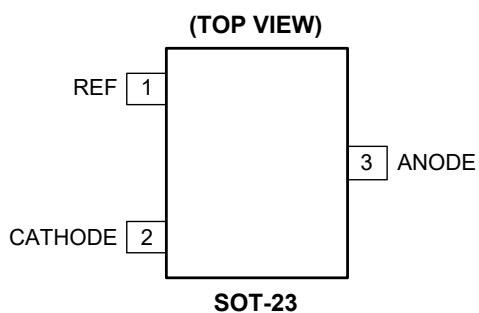
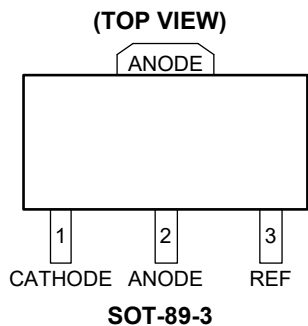

PIN DESCRIPTION

PIN			NAME	TYPE	DESCRIPTION
SOT-89-3	SOT-23	SOT-23-5			
1	2	4	CATHODE	I/O	Cathode Pin. Voltage input and shunts current.
2	3	2	ANODE	O	Anode Pin. Connect to ground normally.
3	1	5	REF	I	REF Input Pin. Threshold Related to the voltage of ANODE Pin.
–	–	1, 3	NC	–	Not Connected.

NOTE: I: input, O: output, I/O: input or output.

FUNCTIONAL BLOCK DIAGRAM

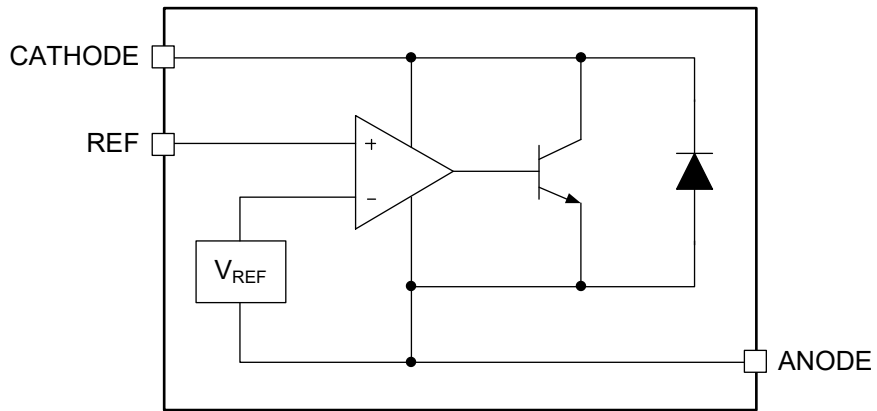

Figure 2. Equivalent Diagram

ELECTRICAL CHARACTERISTICS

(Over recommended operating conditions, $T_J = +25^\circ\text{C}$, unless otherwise noted.)

PARAMETER	SYMBOL	CONDITIONS	MIN	TYP	MAX	UNITS
SGM432						
Reference Voltage	V_{REF}	$V_{KA} = V_{REF}, I_{KA} = 10\text{mA}$	2.475	2.500	2.525	V
Deviation of Reference Input Voltage over Full Temperature Range ⁽¹⁾	$V_{I(DEV)}$	$V_{KA} = V_{REF}, I_{KA} = 10\text{mA}$		5	25	mV
Ratio of Change in Reference Voltage to the Change in Cathode Voltage	$\Delta V_{REF}/\Delta V_{KA}$	$I_{KA} = 10\text{mA}$	$\Delta V_{KA} = 10\text{V} - V_{REF}$	-0.5	-1.0	mV/V
			$\Delta V_{KA} = 36\text{V} - 10\text{V}$	0.1	0.5	
Reference Input Current	I_{REF}	$I_{KA} = 10\text{mA}, R_1 = 10\text{k}\Omega, R_2 = \infty$		1	2	μA
Deviation of Reference Input Current over Full Temperature Range ⁽¹⁾	$I_{I(DEV)}$	$I_{KA} = 10\text{mA}, R_1 = 10\text{k}\Omega, R_2 = \infty$		0.4	0.8	μA
Minimum Cathode Current for Regulation	I_{MIN}	$V_{KA} = V_{REF}$		0.4	0.7	mA
Off-State Cathode Current	I_{OFF}	$V_{KA} = 36\text{V}, V_{REF} = 0$		0.1	1	μA
Dynamic Impedance ⁽²⁾	$ Z_{KA} $	$V_{KA} = V_{REF}, f \leq 1\text{kHz}, I_{KA} = 1\text{mA to } 100\text{mA}$		0.1	0.5	Ω
SGM432B						
Reference Voltage	V_{REF}	$V_{KA} = V_{REF}, I_{KA} = 10\text{mA}$	2.488	2.500	2.512	V
Deviation of Reference Input Voltage over Full Temperature Range ⁽¹⁾	$V_{I(DEV)}$	$V_{KA} = V_{REF}, I_{KA} = 10\text{mA}$		5	25	mV
Ratio of Change in Reference Voltage to the Change in Cathode Voltage	$\Delta V_{REF}/\Delta V_{KA}$	$I_{KA} = 10\text{mA}$	$\Delta V_{KA} = 10\text{V} - V_{REF}$	-0.5	-1.0	mV/V
			$\Delta V_{KA} = 36\text{V} - 10\text{V}$	0.1	0.5	
Reference Input Current	I_{REF}	$I_{KA} = 10\text{mA}, R_1 = 10\text{k}\Omega, R_2 = \infty$		1	2	μA
Deviation of Reference Input Current over Full Temperature Range ⁽¹⁾	$I_{I(DEV)}$	$I_{KA} = 10\text{mA}, R_1 = 10\text{k}\Omega, R_2 = \infty$		0.4	0.8	μA
Minimum Cathode Current for Regulation	I_{MIN}	$V_{KA} = V_{REF}$		0.4	0.7	mA
Off-State Cathode Current	I_{OFF}	$V_{KA} = 36\text{V}, V_{REF} = 0$		0.1	1	μA
Dynamic Impedance ⁽²⁾	$ Z_{KA} $	$V_{KA} = V_{REF}, f \leq 1\text{kHz}, I_{KA} = 1\text{mA to } 100\text{mA}$		0.1	0.5	Ω

NOTES:

1. $V_{I(DEV)}$ and $I_{I(DEV)}$ refer to the difference between the maximum value and the minimum value obtained within the rated temperature range. α_{VREF} is defined as:

$$|\alpha_{VREF}| \left(\frac{\text{ppm}}{^\circ\text{C}} \right) = \left| \frac{\left(\frac{V_{I(DEV)}}{V_{REF} \text{ at } 25^\circ\text{C}} \right) \times 10^6}{\Delta T_J} \right|$$

where,

ΔT_J is the rated operating junction temperature range of the device.

α_{VREF} is the average full-range temperature coefficient of the reference input voltage.

2. $|Z_{KA}| = \Delta V_{KA} / \Delta I_{KA}$, when the device is operating with two external resistors, the total dynamic impedance of the circuit is equal to

$$|Z'| = \frac{\Delta V}{\Delta I}, \text{ which is approximately equal to } |Z_{KA}| \left(1 + \frac{R_1}{R_2} \right)$$

TYPICAL PERFORMANCE CHARACTERISTICS

T_J = +25°C, unless otherwise noted.

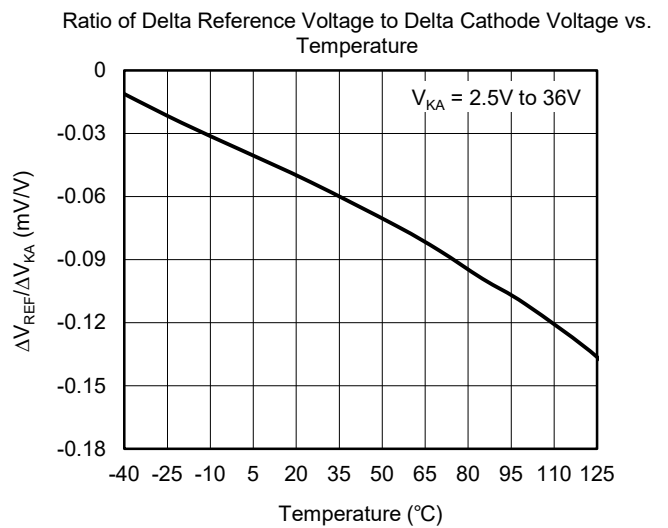
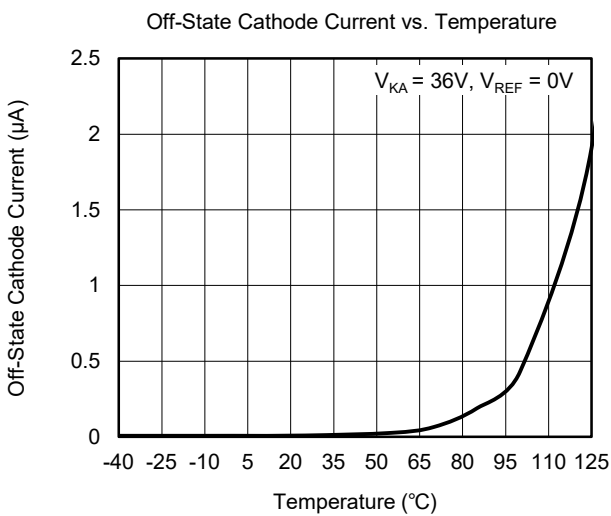
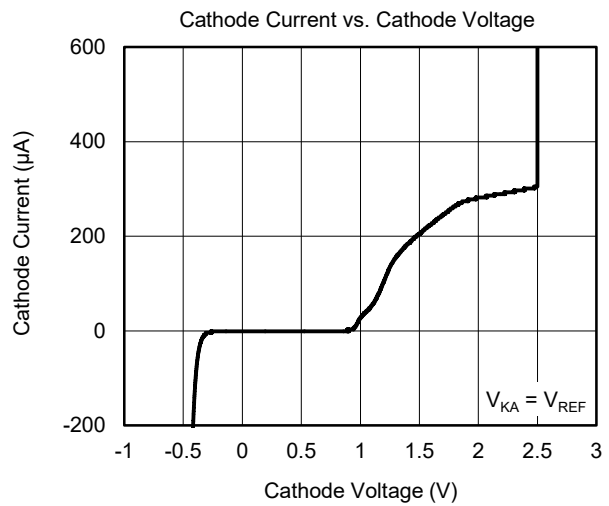
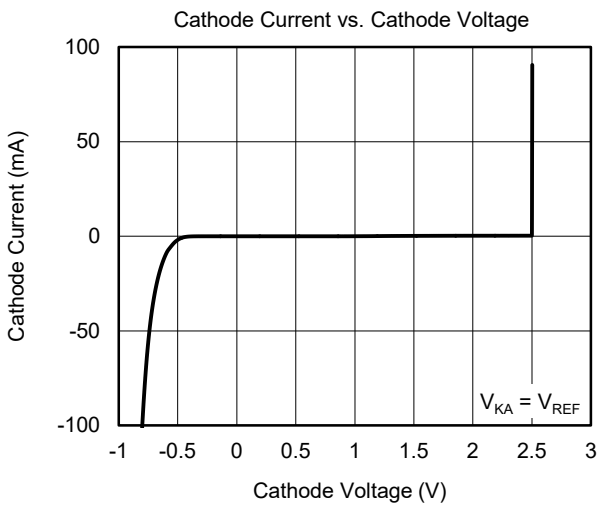
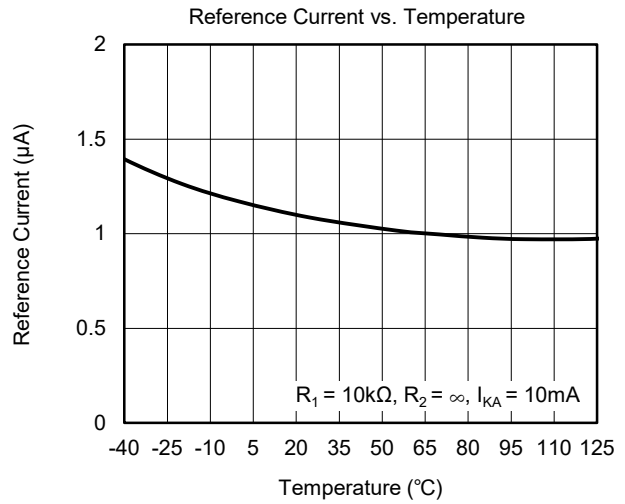
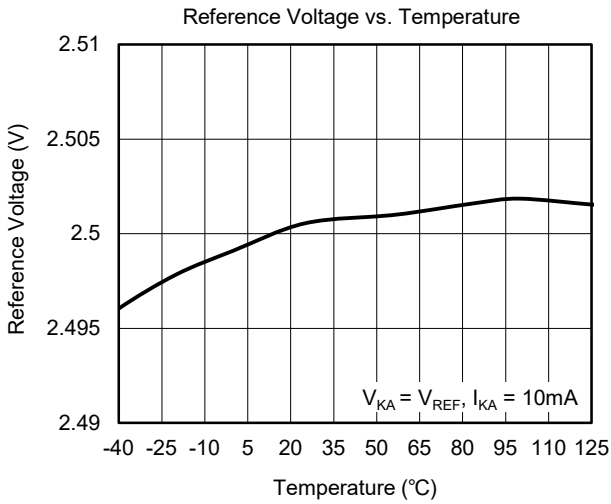

TYPICAL PERFORMANCE CHARACTERISTICS (continued)

T_J = +25°C, unless otherwise noted.

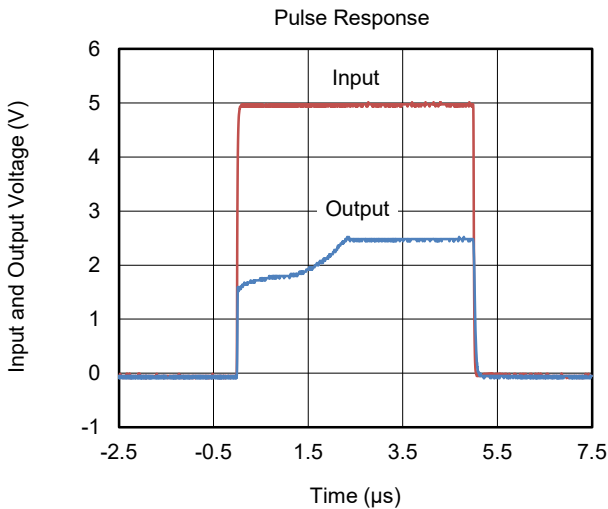
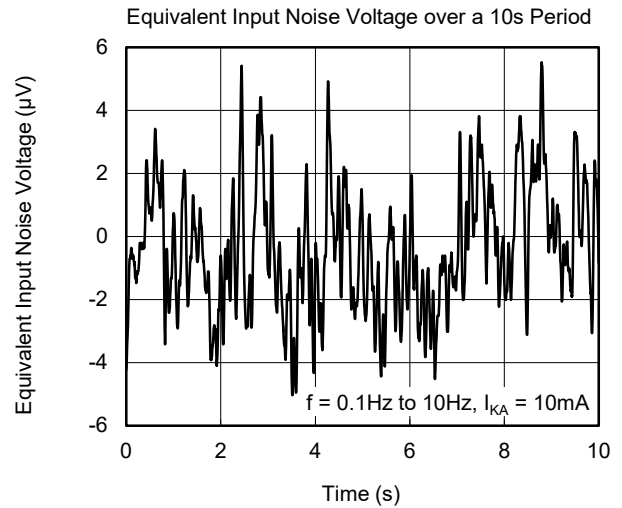
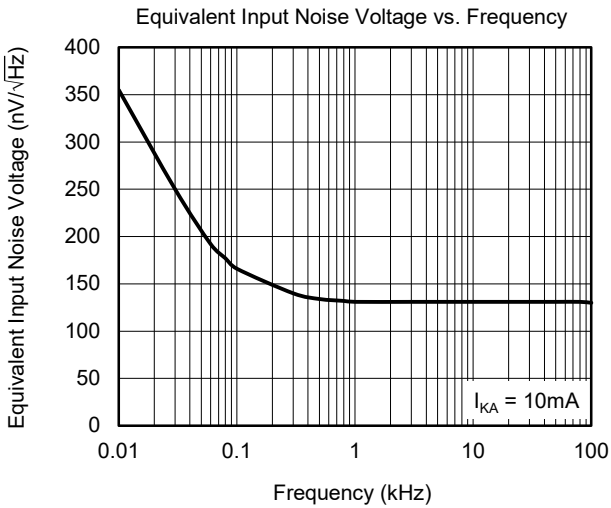
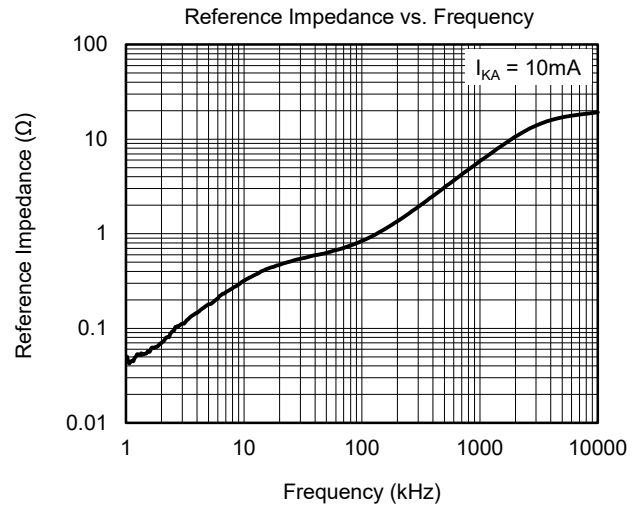
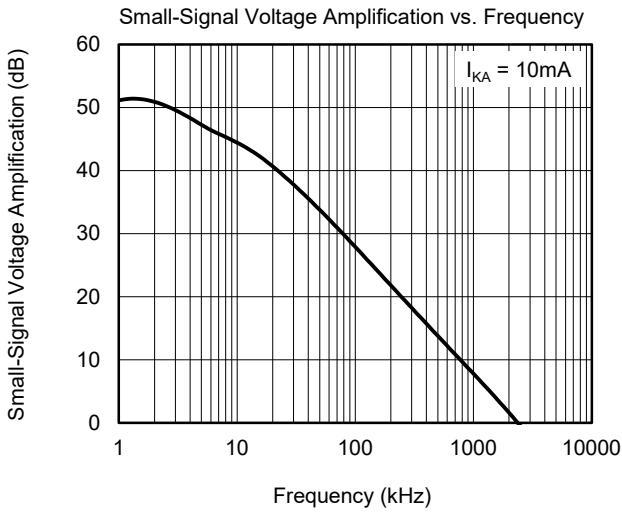

APPLICATION INFORMATION

SGM432x Used as Comparator with Integrated Reference

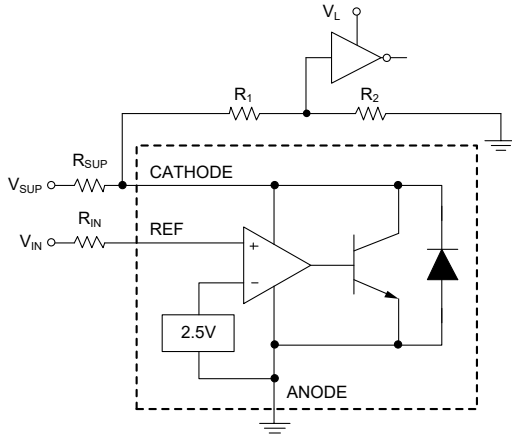

Figure 3. Comparator Application Schematic

Table 1. Design Parameters

Design Parameter	Example Value
Input Voltage Range	0V to 5V
Input Resistance (R_{IN})	10k Ω
Supply Voltage Range (V_{SUP})	5V to 24V
Supply Resistance (R_{SUP})	1k Ω
Output Voltage Level	~ 2V (Logical "Low") ~ V_{SUP} (Logical "High")

As shown in Figure 3, the SGM432x is always used as a comparator with 2.5V integrated reference in application, for this design, the parameters are listed in Table 1. The REF pin voltage is compared with reference inside and is amplified. Also, the SGM432x responds fast if the operation current I_{KA} is large enough. In Figure 4, it is clear to see that the output response with $R_{SUP} = 1k\Omega$ is much faster than $R_{SUP} = 10k\Omega$. The maximum cathode current of I_{MIN} is 0.7mA, any cathode current below this value will cause a low response (low open-loop gain) for the application of comparator.

The overdrive voltage is defined as the voltage over the internal reference voltage (2.5V). If the overdrive voltage is not large enough, the output response will be

inaccurate and slow. On the contrary, the larger overdrive voltage provided at the REF pin, the faster the output response will be. Moreover, if the users desire fast response, the overdrive voltage should be larger than 10% of the internal voltage reference.

The input resistance should be less than 10k Ω in order to minimize the voltage drop between V_{IN} and V_{REF} . The readability of the logic output of the comparator should be guaranteed so that it can be received by the next stage. In Figure 4, the V_{IL} of the comparator logic is 2V, which is sufficient for a 5V supply voltage. However, for the logic stage which is powered by 1.8V or 3.3V, the V_{IL} is hard to be figured out. To accommodate this, a voltage divider should be taken into account. Due to the Open-Collector (OC) output stage, the V_{IH} is equal to the voltage of its power supply. When the voltage divider is used to attenuate V_{IH} , please make sure that the sum of R_1 and R_2 is greater than the resistance R_{SUP} to the power supply.

However, for this application, an external resistor R_{IN} is required to provide the I_{REF} and guarantee the normal operation of the SGM432x. Also, because of the voltage drop across R_{IN} , so that the gap between V_{IN} and V_{REF} is the voltage drop of R_{IN} . To decrease the error, the selected R_{IN} should be small enough as the maximum I_{REF} is 2 μ A.

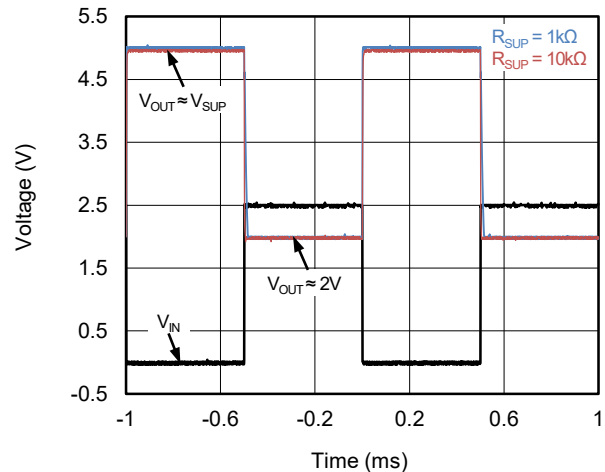

Figure 4. Output Response with Various Cathode Current

APPLICATION INFORMATION (continued)

Shunt Regulator/Reference

Total Accuracy

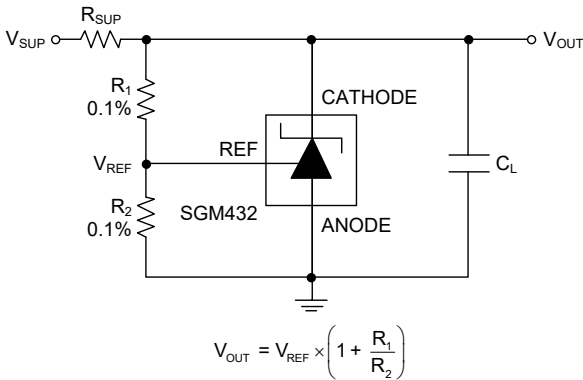

Figure 5. Shunt Regulator Schematic

As shown in Figure 5, for this design, the input parameters are listed in Table 2.

Table 2. Design Parameters

Design Parameter	Example Value
Supply Voltage	40V
Cathode Current (I _{KA})	5mA
Output Voltage Range	2.5V to 36V
Load Capacitance	100nF
Feedback Resistor Values and Accuracy (R ₁ and R ₂)	10kΩ (0.1%)

Programming Output Voltage

The output/cathode voltage of the SGM432x is programmed by resistor R₁ and R₂. The following equation shows the relationship between V_{REF} and V_{OUT}. In accurate applications, the error caused by I_{REF} should also be taken into account:

$$V_{OUT} = V_{REF} \left(1 + \frac{R_1}{R_2} \right) + I_{REF} \times R_1$$

And the users need to ensure that the SGM432x is fully biased, so that this error can be decreased significantly by the enough open-loop gain. This can be qualified by satisfying the minimum cathode current I_{MIN} in Electrical Characteristics.

When the output voltage is set higher than unity gain (2.5V), the behavior of the SGM432x will be influenced by the following possible errors:

- ◆ The accuracy of both R₁ and R₂.
- ◆ The internal reference voltage will be changed by the temperature.
- ◆ ΔV_{REF}/ΔV_{KA}: The change of internal reference voltage will affect the output voltage.
- ◆ |Z_{KA}|: This impedance will be affected by the cathode current.

The above possible errors are the worst cases for the operation of the SGM432x.

Stability

For traditional 431 devices, the reference output stability is affected by output decoupling capacitor which must be selected in a limited range in order to keep 431 devices stable in applications. However, the SGM432x is different from the others. The SGM432x uses a special design to greatly improve output stability when it drives capacitive load. From the curve of the Cathode Current vs. Load Capacitance in Figure 6, the output of the SGM432x is stable in a wider range of capacitive load. If the SGM432x is used as a linear regulator, a bigger decoupling capacitor can be used to improve regulator's load transient or reduce the noise of power supply. If the SGM432x is used to replace the others, the SGM432x will be stable and there is no need to change the output decoupling capacitor in the original design.

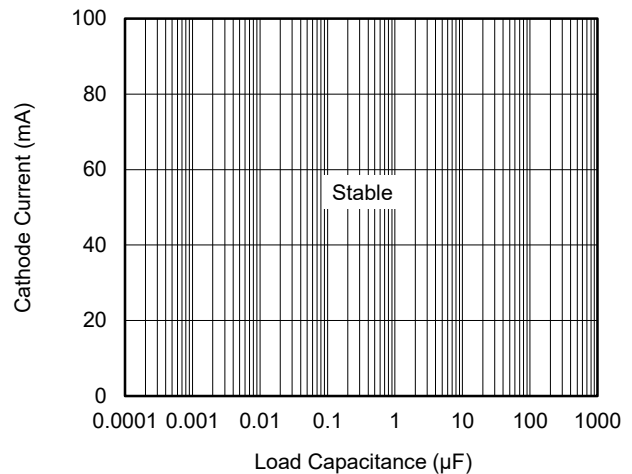

Figure 6. Cathode Current vs. Load Capacitance

APPLICATION INFORMATION (continued)

Start-Up Time

As shown in Figure 7, the SGM432x is suitable for many clamp applications with the fast response.

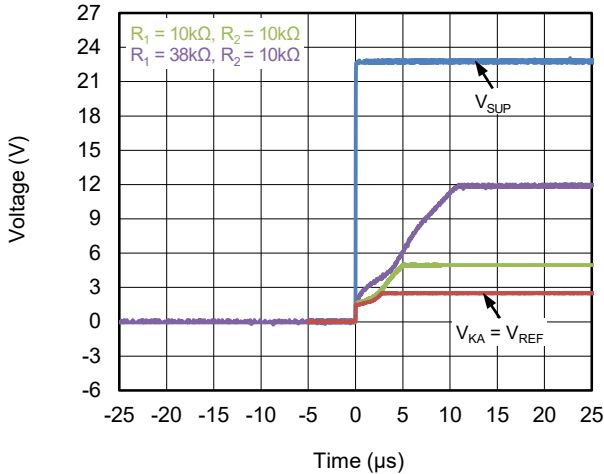

Figure 7. SGM432x Start-Up Response

Power Supply Recommendations

When the SGM432x is used as a shunt regulator, it is necessary to use a bypass capacitor on the CATHODE pin.

Limiting the current of the power supply is necessary for the SGM432x to operate within the maximum cathode current. Also, the current of the REF pin should be limited as well.

When the device shunts high current, adjusting the width and length of traces on the CATHODE pin and ANODE pin is necessary in the PCB board to have a proper density of current.

Layout

Please make sure that the bypass capacitor is close enough to the part. The width of trace on the PCB should be fit for its amount of current flowing. For the SGM432x, these currents will not be large.

REVISION HISTORY

NOTE: Page numbers for previous revisions may differ from page numbers in the current version.

JUNE 2022 – REV.A.3 to REV.A.4		Page
Updated Application Information section.....		8, 9, 10
NOVEMBER 2020 – REV.A.2 to REV.A.3		Page
Updated Package/Ordering Information section.....		2
SEPTEMBER 2020 – REV.A.1 to REV.A.2		Page
Updated Application Information section.....		10
AUGUST 2020 – REV.A to REV.A.1		Page
Updated Electrical Characteristics section.....		4
Updated Application Information section.....		11
Changes from Original (MAY 2020) to REV.A		Page
Changed from product preview to production data.....		All

PACKAGE OUTLINE DIMENSIONS

SOT-89-3

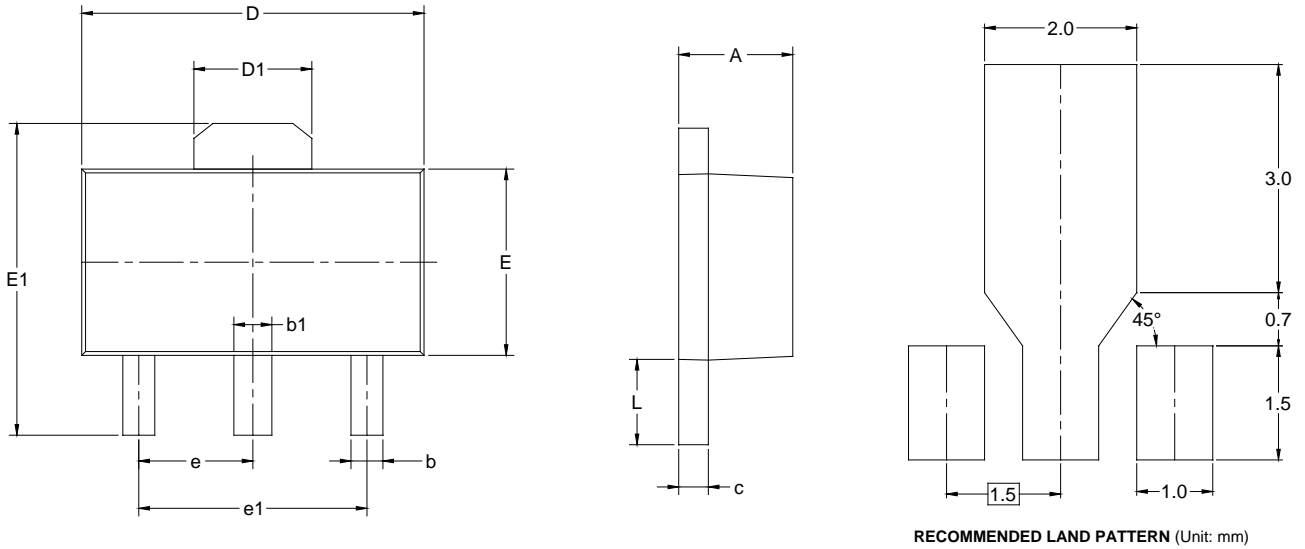

RECOMMENDED LAND PATTERN (Unit: mm)

Symbol	Dimensions In Millimeters		Dimensions In Inches	
	MIN	MAX	MIN	MAX
A	1.400	1.600	0.055	0.063
b	0.320	0.520	0.013	0.020
b1	0.400	0.580	0.016	0.023
c	0.350	0.440	0.014	0.017
D	4.400	4.600	0.173	0.181
D1	1.550 REF		0.061 REF	
E	2.300	2.600	0.091	0.102
E1	3.940	4.250	0.155	0.167
e	1.500 TYP		0.060 TYP	
e1	3.000 TYP		0.118 TYP	
L	0.900	1.200	0.035	0.047

NOTES:

1. Body dimensions do not include mode flash or protrusion.
2. This drawing is subject to change without notice.

PACKAGE OUTLINE DIMENSIONS

SOT-23

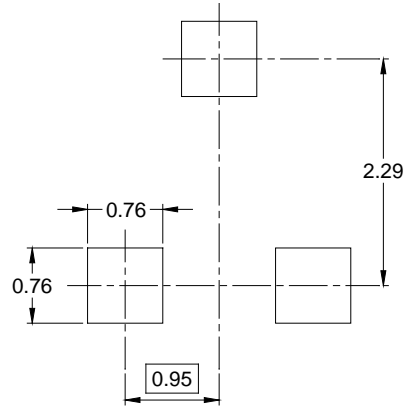
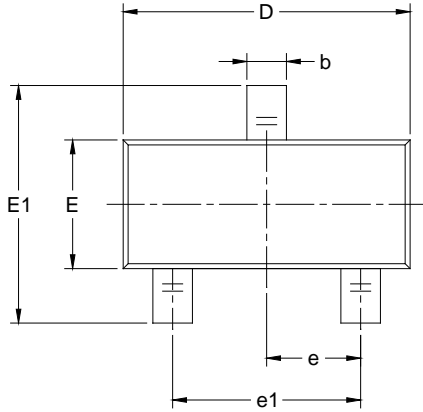

RECOMMENDED LAND PATTERN (Unit: mm)

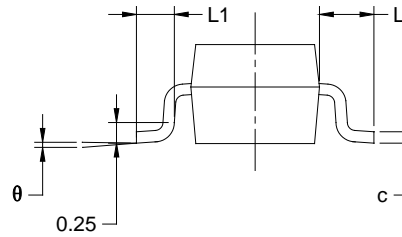
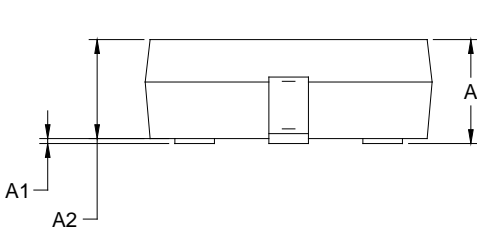

Symbol	Dimensions In Millimeters		Dimensions In Inches	
	MIN	MAX	MIN	MAX
A	0.89	1.12	0.035	0.044
A1	0.01	0.10	0.000	0.004
A2	0.88	1.02	0.035	0.040
b	0.30	0.50	0.012	0.020
c	0.08	0.20	0.003	0.008
D	2.80	3.04	0.110	0.120
E	1.20	1.40	0.047	0.055
E1	2.10	2.64	0.083	0.104
e	0.95 BSC		0.037 BSC	
e1	1.90 BSC		0.075 BSC	
L	0.54 REF		0.021 REF	
L1	0.40	0.60	0.016	0.024
θ	0°	8°	0°	8°

NOTES:

1. Body dimensions do not include mold flash or protrusion.
2. This drawing is subject to change without notice.

PACKAGE OUTLINE DIMENSIONS

SOT-23-5

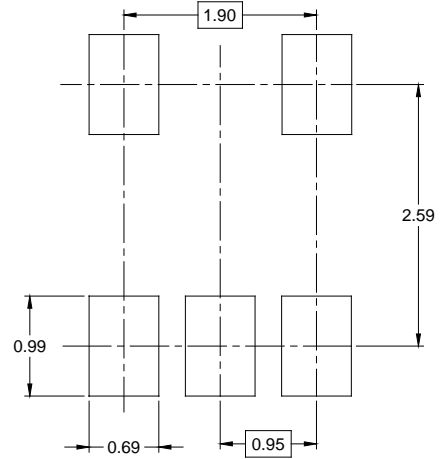
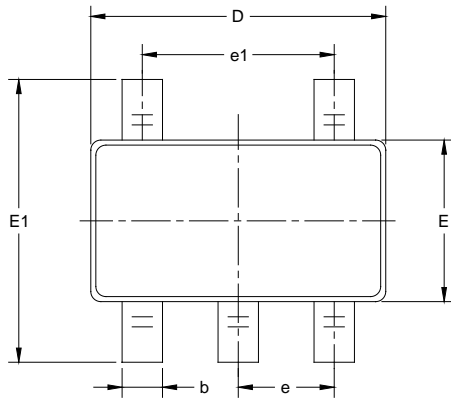

RECOMMENDED LAND PATTERN (Unit: mm)

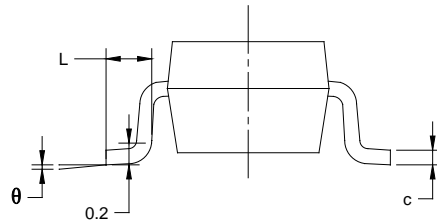
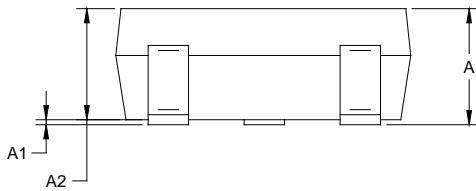

Symbol	Dimensions In Millimeters		Dimensions In Inches	
	MIN	MAX	MIN	MAX
A	1.050	1.250	0.041	0.049
A1	0.000	0.100	0.000	0.004
A2	1.050	1.150	0.041	0.045
b	0.300	0.500	0.012	0.020
c	0.100	0.200	0.004	0.008
D	2.820	3.020	0.111	0.119
E	1.500	1.700	0.059	0.067
E1	2.650	2.950	0.104	0.116
e	0.950 BSC		0.037 BSC	
e1	1.900 BSC		0.075 BSC	
L	0.300	0.600	0.012	0.024
θ	0°	8°	0°	8°

NOTES:

1. Body dimensions do not include mode flash or protrusion.
2. This drawing is subject to change without notice.

PACKAGE INFORMATION

TAPE AND REEL INFORMATION

REEL DIMENSIONS



TAPE DIMENSIONS



NOTE: The picture is only for reference. Please make the object as the standard.

KEY PARAMETER LIST OF TAPE AND REEL

Package Type	Reel Diameter	Reel Width W1 (mm)	A0 (mm)	B0 (mm)	K0 (mm)	P0 (mm)	P1 (mm)	P2 (mm)	W (mm)	Pin1 Quadrant
SOT-89-3	7"	13.2	4.85	4.45	1.85	4.0	8.0	2.0	12.0	Q3
SOT-23	7"	9.5	3.15	2.77	1.22	4.0	4.0	2.0	8.0	Q3
SOT-23-5	7"	9.5	3.20	3.20	1.40	4.0	4.0	2.0	8.0	Q3

DD0001

PACKAGE INFORMATION

CARTON BOX DIMENSIONS



NOTE: The picture is only for reference. Please make the object as the standard.

KEY PARAMETER LIST OF CARTON BOX

Reel Type	Length (mm)	Width (mm)	Height (mm)	Pizza/Carton
7" (Option)	368	227	224	8
7"	442	410	224	18

DD0002