

## DS92LV1023 40-66 MHz 10 Bit Bus LVDS Serializer

Check for Samples: [DS92LV1023](#)

### FEATURES

- 40–66 MHz Single 10:1 Serializer with 400–660 Mb/s Throughput
- Robust Bus LVDS Serial Data Transmission with Embedded Clock for Exceptional Noise Immunity and Low EMI
- Ensured Transition Every Data Transfer Cycle
- Low Power Consumption < 250 mW (typ) @ 66 MHz
- Single Differential Pair Eliminates Multichannel Skew
- Flow-through Pinout for Easy PCB Layout
- Programmable Edge Trigger on Clock
- High Impedance on Driver Outputs When Power is Off
- Bus LVDS Serial Output Rated for 27Ω Load
- Small 28-lead SSOP Package

### DESCRIPTION

The DS92LV1023 is a 400 to 660 Mb/s serializer for high-speed unidirectional serial data transmission over FR-4 printed circuit board backplanes and balanced copper cables. It transforms a 10-bit wide parallel LVCMOS/LVTTL data bus into a single high speed Bus LVDS serial data stream with embedded clock. This single serial data stream simplifies PCB design and reduces PCB cost by narrowing data paths that in turn reduce PCB size and number of layers. The single serial data stream also reduces cable size, the number of connectors, and eliminates clock-to-data and data-to-data skew.

The DS92LV1023 works well with any Texas Instruments' Bus LVDS 10-bit deserializer within its specified frequency operating range. It features low power consumption, pin selectable edge trigger on clock, and high impedance outputs in power down mode.

The DS92LV1023 was designed with the flow-through pinout and is available in a space saving 28-lead SSOP package.

### Block Diagram

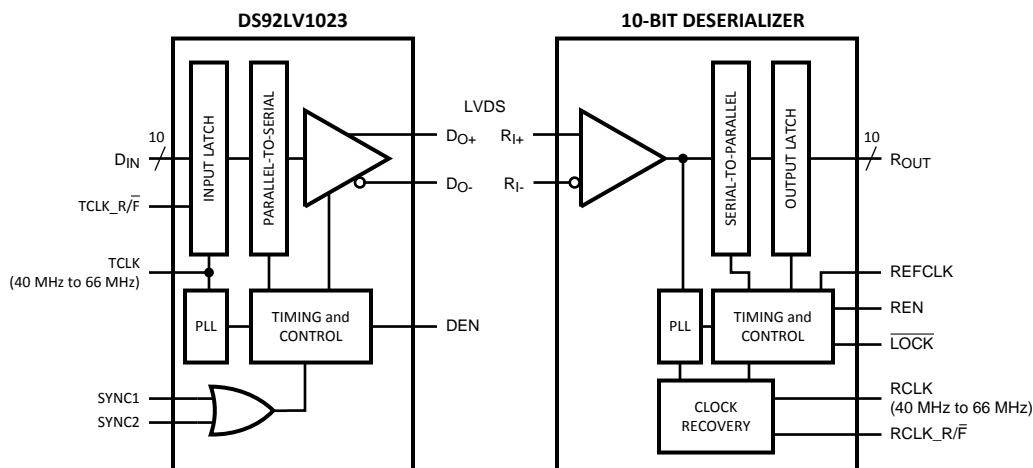

Figure 1.



Please be aware that an important notice concerning availability, standard warranty, and use in critical applications of Texas Instruments semiconductor products and disclaimers thereto appears at the end of this data sheet.

All trademarks are the property of their respective owners.

## Application

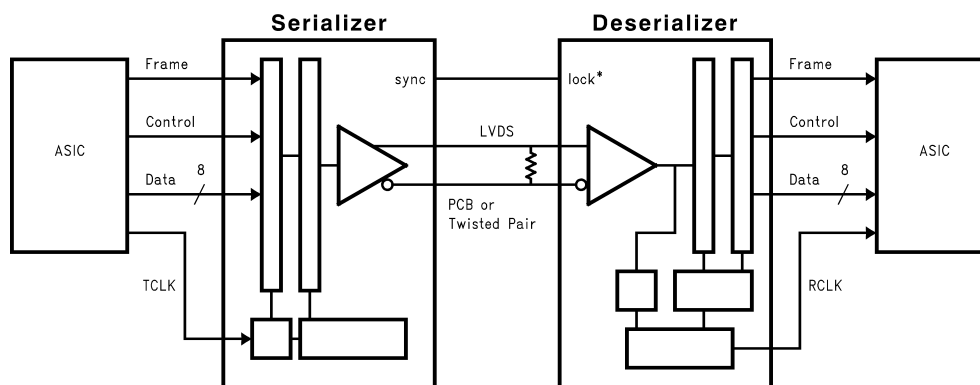

Figure 2.

## Functional Description

The DS92LV1023 is a 10-bit Serializer device which together with a compatible deserializer (i.e. DS92LV1224) forms a chipset designed to transmit data over FR-4 printed circuit board backplanes and balanced copper cables at clock speeds from 40 to 66 MHz.

The chipset has three active states of operation: Initialization, Data Transfer, and Resynchronization; and two passive states: Powerdown and TRI-STATE.

The following sections describe each operation and passive state.

### Initialization

Initialization of both devices must occur before data transmission begins. Initialization refers to synchronization of the Serializer and Deserializer PLL's to local clocks, which may be the same or separate. Afterwards, synchronization of the Deserializer to Serializer occurs.

Step 1: When you apply  $V_{CC}$  to both Serializer and/or Deserializer, the respective outputs enter TRI-STATE, and on-chip power-on circuitry disables internal circuitry. When  $V_{CC}$  reaches  $V_{CCOK}$  (2.5V) the PLL in each device begins locking to a local clock. For the Serializer, the local clock is the transmit clock (TCLK) provided by the source ASIC or other device. For the Deserializer, you must apply a local clock to the REFCLK pin.

The Serializer outputs remain in TRI-STATE while the PLL locks to the TCLK. After locking to TCLK, the Serializer is now ready to send data or SYNC patterns, depending on the levels of the SYNC1 and SYNC2 inputs or a data stream. The SYNC pattern sent by the Serializer consists of six ones and six zeros switching at the input clock rate.

Note that the Deserializer  $\overline{LOCK}$  output will remain high while its PLL locks to the incoming data or to SYNC patterns on the input.

Step 2: The Deserializer PLL must synchronize to the Serializer to complete initialization. The Deserializer will lock to non-repetitive data patterns. However, the transmission of SYNC patterns enables the Deserializer to lock to the Serializer signal within a specified time. See [Figure 9](#).

The user's application determines control of the SYNC1 and SYNC 2 pins. One recommendation is a direct feedback loop from the  $\overline{LOCK}$  pin. Under all circumstances, the Serializer stops sending SYNC patterns after both SYNC inputs return low.

When the Deserializer detects edge transitions at the Bus LVDS input, it will attempt to lock to the embedded clock information. When the Deserializer locks to the Bus LVDS clock, the  $\overline{LOCK}$  output will go low. When  $\overline{LOCK}$  is low, the Deserializer outputs represent incoming Bus LVDS data.

## Data Transfer

After initialization, the Serializer will accept data from inputs DIN0–DIN9. The Serializer uses the TCLK input to latch incoming Data. The TCLK\_R/F pin selects which edge the Serializer uses to strobe incoming data. TCLK\_R/F high selects the rising edge for clocking data and low selects the falling edge. If either of the SYNC inputs is high for 5\*TCLK cycles, the data at DIN0–DIN9 is ignored regardless of clock edge.

After determining which clock edge to use, a start and stop bit, appended internally, frame the data bits in the register. The start bit is always high and the stop bit is always low. The start and stop bits function as the embedded clock bits in the serial stream.

The Serializer transmits serialized data and clock bits (10+2 bits) from the serial data output (DO±) at 12 times the TCLK frequency. For example, if TCLK is 66 MHz, the serial rate is  $66 \times 12 = 792$  Mega-bits-per-second. Since only 10 bits are from input data, the serial “payload” rate is 10 times the TCLK frequency. For instance, if TCLK = 66 MHz, the payload data rate is  $66 \times 10 = 660$  Mbps. The data source provides TCLK and must be in the range of 40 MHz to 66 MHz nominal.

The Serializer outputs (DO±) can drive a point-to-point connection or in limited multi-point or multi-drop backplanes. The outputs transmit data when the enable pin (DEN) is high, PWRDN = high, and SYNC1 and SYNC2 are low. When DEN is driven low, the Serializer output pins will enter TRI-STATE.

When the Deserializer synchronizes to the Serializer, the  $\overline{\text{LOCK}}$  pin is low. The Deserializer locks to the embedded clock and uses it to recover the serialized data. ROUT data is valid when  $\overline{\text{LOCK}}$  is low. Otherwise ROUT0–ROUT9 is invalid.

The ROUT0–ROUT9 pins use the RCLK pin as the reference to data. The polarity of the RCLK edge is controlled by the RCLK\_R/F input.

ROUT(0-9),  $\overline{\text{LOCK}}$  and RCLK outputs will drive a maximum of three CMOS input gates (15 pF load) with a 66 MHz clock.

## Resynchronization

When the Deserializer PLL locks to the embedded clock edge, the Deserializer  $\overline{\text{LOCK}}$  pin asserts a low. If the Deserializer loses lock, the  $\overline{\text{LOCK}}$  pin output will go high and the outputs (including RCLK) will enter TRI-STATE.

The user's system monitors the  $\overline{\text{LOCK}}$  pin to detect a loss of synchronization. Upon detection, the system can arrange to pulse the Serializer SYNC1 or SYNC2 pin to resynchronize. Multiple resynchronization approaches are possible. One recommendation is to provide a feedback loop using the  $\overline{\text{LOCK}}$  pin itself to control the sync request of the Serializer (SYNC1 or SYNC2). Dual SYNC pins are provided for multiple control in a multi-drop application. Sending sync patterns for resynchronization is desirable when lock times within a specific time are critical. However, the Deserializer can lock to random data, which is discussed in the next section.

## Random Lock Initialization and Resynchronization

The initialization and resynchronization methods described in their respective sections are the fastest ways to establish the link between the Serializer and Deserializer. However, the DS92LV1224 can attain lock to a data stream without requiring the Serializer to send special SYNC patterns. This allows the DS92LV1224 to operate in “open-loop” applications. Equally important is the Deserializer's ability to support hot insertion into a running backplane. In the open loop or hot insertion case, we assume the data stream is essentially random. Therefore, because lock time varies due to data stream characteristics, we cannot possibly predict exact lock time. The primary constraint on the “random” lock time is the initial phase relation between the incoming data and the REFCLK when the Deserializer powers up. As described in the next paragraph, the data contained in the data stream can also affect lock time.

If a specific pattern is repetitive, the Deserializer could enter “false lock” - falsely recognizing the data pattern as the clocking bits. We refer to such a pattern as a repetitive multi-transition, RMT. This occurs when more than one Low-High transition takes place in a clock cycle over multiple cycles. This occurs when any bit, except DIN 9, is held at a low state and the adjacent bit is held high, creating a 0-1 transition. In the worst case, the Deserializer could become locked to the data pattern rather than the clock. Circuitry within the DS92LV1224 can detect that the possibility of “false lock” exists. The circuitry accomplishes this by detecting more than one

potential position for clocking bits. Upon detection, the circuitry will prevent the  $\overline{\text{LOCK}}$  output from becoming active until the potential “false lock” pattern changes. The false lock detect circuitry expects the data will eventually change, causing the Deserializer to lose lock to the data pattern and then continue searching for clock bits in the serial data stream. Graphical representations of RMT are shown in Figure 3. Please note that RMT only applies to bits DIN0-DIN8.

## Powerdown

When no data transfer occurs, you can use the Powerdown state. The Serializer and Deserializer use the Powerdown state, a low power sleep mode, to reduce power consumption. The Deserializer enters Powerdown when you drive PWRDN and REN low. The Serializer enters Powerdown when you drive PWRDN low. In Powerdown, the PLL stops and the outputs enter TRI-STATE, which disables load current and reduces supply current to the milliampere range. To exit Powerdown, you must drive the PWRDN pin high.

Before valid data exchanges between the Serializer and Deserializer, you must reinitialize and resynchronize the devices to each other. Initialization of the Serializer takes 510 TCLK cycles. The Deserializer will initialize and assert  $\overline{\text{LOCK}}$  high until lock to the Bus LVDS clock occurs.

## TRI-STATE

The Serializer enters TRI-STATE when the DEN pin is driven low. This puts both driver output pins (DO+ and DO-) into TRI-STATE. When you drive DEN high, the Serializer returns to the previous state, as long as all other control pins remain static (SYNC1, SYNC2, PWRDN, TCLK\_R/F).

When you drive the REN pin low, the Deserializer enters TRI-STATE. Consequently, the receiver output pins (ROUT0–ROUT9) and RCLK will enter TRI-STATE. The  $\overline{\text{LOCK}}$  output remains active, reflecting the state of the PLL.

DIN0 Held Low-DIN1 Held High Creates an RMT Pattern

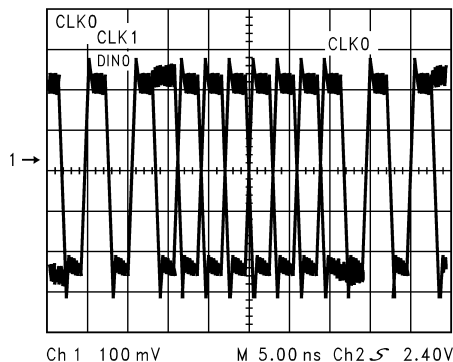

DIN4 Held Low-DIN5 Held High Creates an RMT Pattern

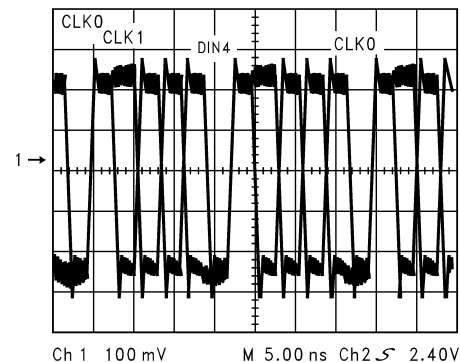

DIN8 Held Low-DIN9 Held High Creates an RMT Pattern

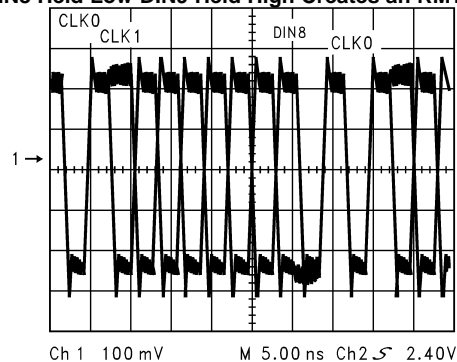

Figure 3. RMT Patterns Seen on the Bus LVDS Serial Output



These devices have limited built-in ESD protection. The leads should be shorted together or the device placed in conductive foam during storage or handling to prevent electrostatic damage to the MOS gates.

## Absolute Maximum Ratings <sup>(1)(2)</sup>

Supply Voltage ( $V_{CC}$ )	-0.3V to +4V
LVC MOS/LVTTL Input Voltage	-0.3V to ( $V_{CC} + 0.3V$ )
LVC MOS/LVTTL Output Voltage	-0.3V to ( $V_{CC} + 0.3V$ )
Bus LVDS Driver Output Voltage	-0.3V to +3.9V
Bus LVDS Output Short Circuit Duration	10mS
Junction Temperature	+150°C
Storage Temperature	-65°C to +150°C
Lead Temperature (Soldering, 4 seconds)	+260°C
Maximum Package Power Dissipation Capacity	
@ 25°C Package: 28L SSOP	1.27 W
Package Derating:	
	10.3 mW/°C above
28L SSOP	+25°C
$\theta_{ja}$	97°C/W
$\theta_{jc}$	27°C/W
ESD Rating	
HBM (1.5kOhm, 100pF)	>1kV
MM	> 250V

- (1) “Absolute Maximum Ratings” are those values beyond which the safety of the device cannot be verified. They are not meant to imply that the devices should be operated at these limits. The table of “Electrical Characteristics” specifies conditions of device operation.
- (2) If Military/Aerospace specified devices are required, please contact the TI Sales Office/ Distributors for availability and specifications.

## Recommended Operating Conditions

	Min	Nom	Max	Units
Supply Voltage ( $V_{CC}$ )	3.0	3.3	3.6	V
Operating Free Air Temperature ( $T_A$ )	-40	+25	+85	°C
Supply Noise Voltage ( $V_{CC}$ )			100	mV <sub>p-p</sub>

## Electrical Characteristics <sup>(1)</sup>

Over recommended operating supply and temperature ranges unless otherwise specified.

Parameter	Test Conditions	Min	Typ <sup>(2)</sup>	Max	Units
<b>SERIALIZER LVC MOS/LVTTL DC SPECIFICATIONS (apply to DIN0-9, TCLK, PWRDN, TCLK_R/F, SYNC1, SYNC2, DEN)</b>					
$V_{IH}$	High Level Input Voltage	2.0		$V_{CC}$	V
$V_{IL}$	Low Level Input Voltage	GND		0.8	V
$V_{CL}$	Input Clamp Voltage		-0.86	-1.5	V
$I_{IN}$	Input Current		$\pm 1$	+10	$\mu A$
<b>SERIALIZER Bus LVDS DC SPECIFICATIONS (apply to pins DO+ and DO-)</b>					
$V_{OD}$	Output Differential Voltage (DO+)-(DO-)	200	290		mV
$\Delta V_{OD}$	Output Differential Voltage Unbalance			35	mV
$V_{OS}$	Offset Voltage	1.05	1.1	1.3	V
$\Delta V_{OS}$	Offset Voltage Unbalance		4.8	35	mV
$I_{OS}$	Output Short Circuit Current		-56	-90	mA
$I_{OZ}$	TRI-STATE Output Current	-10	$\pm 1$	+10	$\mu A$
$I_{OX}$	Power-Off Output Current	-20	$\pm 1$	+25	$\mu A$

- (1) Current into device pins is defined as positive. Current out of device pins is defined as negative. Voltages are referenced to ground except  $V_{OD}$ ,  $\Delta V_{OD}$ ,  $V_{TH}$  and  $V_{TL}$  which are differential voltages.
- (2) Typical values are given for  $V_{CC} = 3.3V$  and  $T_A = +25^\circ C$ .

## Electrical Characteristics<sup>(1)</sup> (continued)

Over recommended operating supply and temperature ranges unless otherwise specified.

Parameter		Test Conditions		Min	Typ <sup>(2)</sup>	Max	Units
<b>SERIALIZER SUPPLY CURRENT (apply to pins DVCC and AVCC)</b>							
I <sub>CCD</sub>	Serializer Supply Current	RL = 27Ω	f = 40 MHz		47	60	mA
	Worst Case	See <a href="#">Figure 4</a>	f = 66 MHz		75	90	mA
I <sub>CCXD</sub>	Serializer Supply Current Powerdown	PWRDN = 0.8V			47	500	μA

## Serializer Timing Requirements for TCLK

Over recommended operating supply and temperature ranges unless otherwise specified.

Parameter		Test Conditions		Min	Typ <sup>(1)</sup>	Max	Units
t <sub>TCP</sub>	Transmit Clock Period			15.15	T	25.0	nS
t <sub>TCH</sub>	Transmit Clock High Time			0.4T	0.5T	0.6T	nS
t <sub>TCL</sub>	Transmit Clock Low Time			0.4T	0.5T	0.6T	nS
t <sub>CLKT</sub>	TCLK Input Transition Time				3	6	nS
t <sub>JIT</sub>	TCLK Input Jitter					150	pS (RMS)

(1) Typical values are given for V<sub>CC</sub> = 3.3V and T<sub>A</sub> = +25°C.

## Serializer Switching Characteristics

Over recommended operating supply and temperature ranges unless otherwise specified.

Parameter		Test Conditions		Min	Typ <sup>(1)</sup>	Max	Units
t <sub>LLHT</sub>	Bus LVDS Low-to-High Transition Time	R <sub>L</sub> = 27Ω C <sub>L</sub> = 10pF to GND			0.2	0.4	nS
t <sub>LHLT</sub>	Bus LVDS High-to-Low Transition Time	See <a href="#">Figure 5</a> See <sup>(2)</sup>			0.25	0.4	nS
t <sub>DIS</sub>	DIN (0-9) Setup to TCLK	R <sub>L</sub> = 27Ω, C <sub>L</sub> = 10pF to GND		0			nS
t <sub>DIH</sub>	DIN (0-9) Hold from TCLK	See <a href="#">Figure 7</a>		4.0			nS
t <sub>HZD</sub>	DO ± HIGH to TRI-STATE Delay	R <sub>L</sub> = 27Ω, C <sub>L</sub> = 10pF to GND			3	10	nS
t <sub>LZD</sub>	DO ± LOW to TRI-STATE Delay	See <a href="#">Figure 8</a> See <sup>(3)</sup>			3	10	nS
t <sub>ZHD</sub>	DO ± TRI-STATE to HIGH Delay				5	10	nS
t <sub>ZLD</sub>	DO ± TRI-STATE to LOW Delay				6.5	10	nS
t <sub>SPW</sub>	SYNC Pulse Width	R <sub>L</sub> = 27Ω <a href="#">Figure 10</a>		5*t <sub>TCP</sub>			nS
t <sub>PLD</sub>	Serializer PLL Lock Time			510*t <sub>TCP</sub>		513*t <sub>TCP</sub>	nS
t <sub>SD</sub>	Serializer Delay	R <sub>L</sub> = 27Ω, <a href="#">Figure 11</a>		t <sub>TCP</sub> + 1.0	t <sub>TCP</sub> + 2.0	t <sub>TCP</sub> + 3.0	nS
t <sub>DJIT</sub>	Deterministic Jitter	R <sub>L</sub> = 27Ω, C <sub>L</sub> = 10pF to GND, <sup>(4)</sup>	40 MHz	-320	-80	150	pS
			66 MHz	-200	-70	80	pS
t <sub>RJIT</sub>	Random Jitter	R <sub>L</sub> = 27Ω, C <sub>L</sub> = 10pF to GND			19	25	pS (RMS)

(1) Typical values are given for V<sub>CC</sub> = 3.3V and T<sub>A</sub> = +25°C.

(2) t<sub>LLHT</sub> and t<sub>LHLT</sub> specifications are Guaranteed By Design (GBD) using statistical analysis.

(3) Because the Serializer is in TRI-STATE mode, the Deserializer will lose PLL lock and have to resynchronize before data transfer.

(4) t<sub>DJIT</sub> specifications are Guaranteed By Design using statistical analysis.

AC TIMING DIAGRAMS AND TEST CIRCUITS

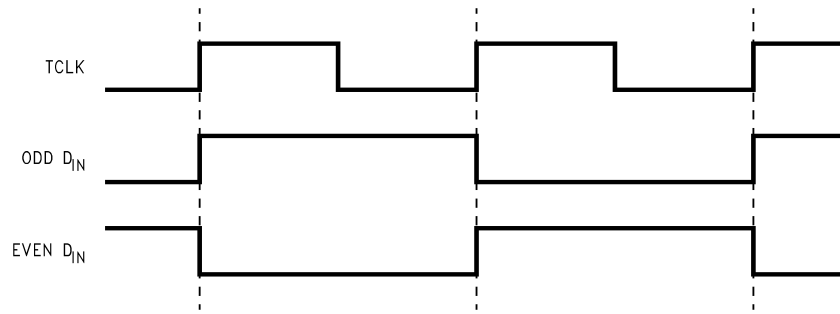

Figure 4. “Worst Case” Serializer ICC Test Pattern

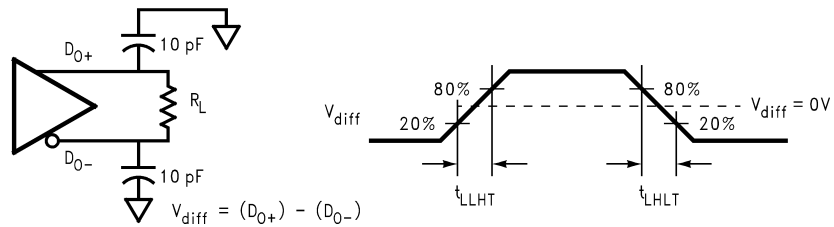

Figure 5. Serializer Bus LVDS Output Load and Transition Times

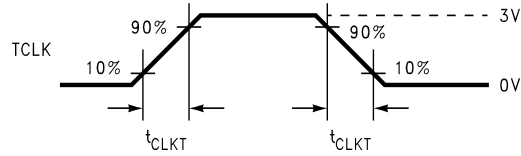
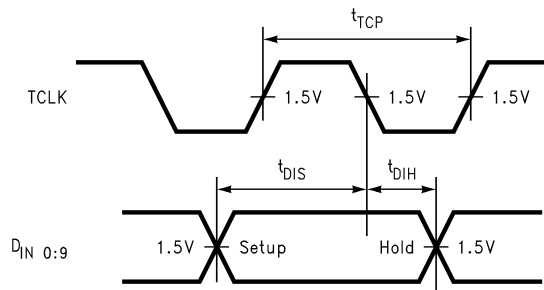
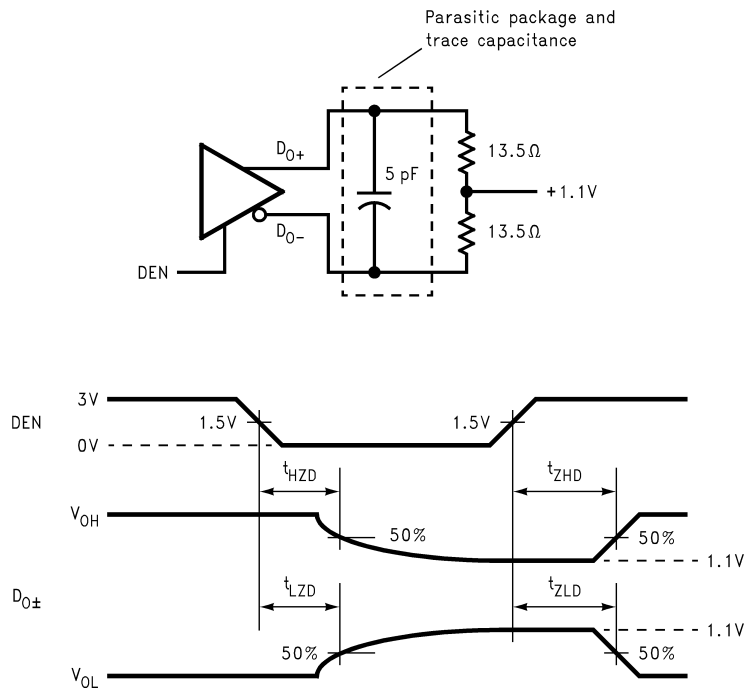

Figure 6. Serializer Input Clock Transition Time



Timing shown for TCLK\_R/F = LOW

Figure 7. Serializer Setup/Hold Times



**Figure 8. Serializer TRI-STATE Test Circuit and Timing**

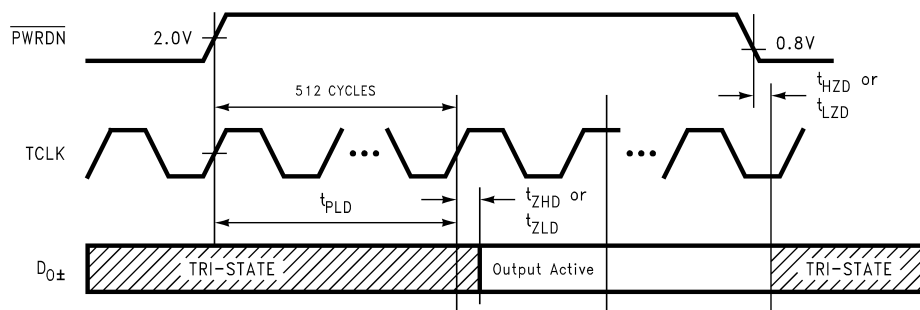

**Figure 9. Serializer PLL Lock Time, and  $\overline{\text{PWRDN}}$  TRI-STATE Delays**



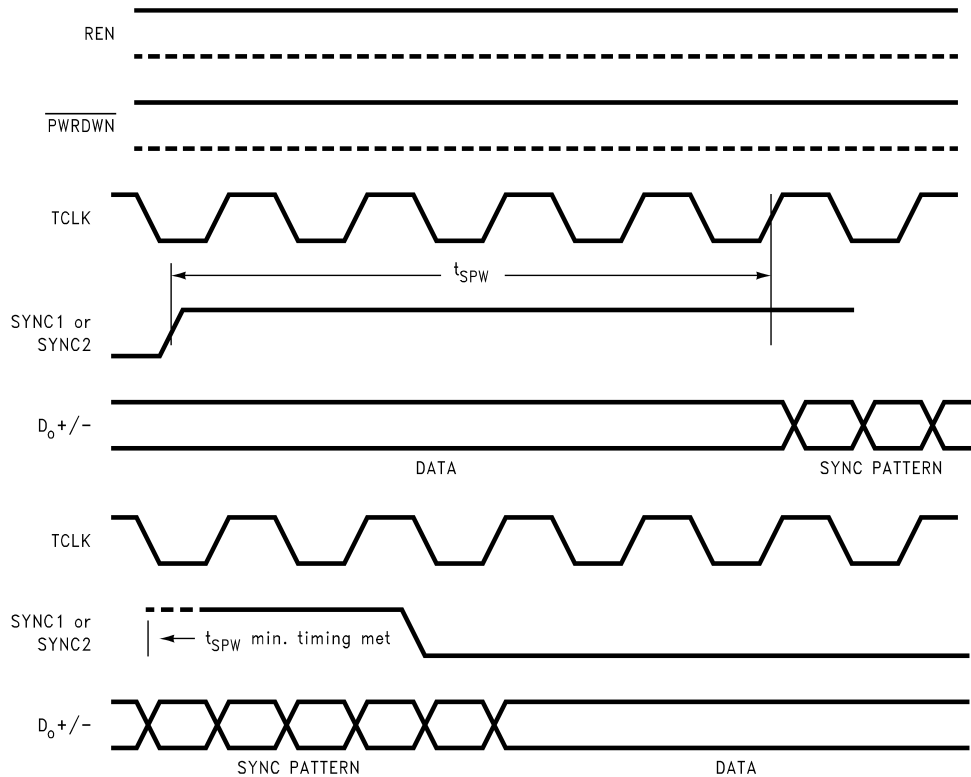

Figure 10. SYNC Timing Delays

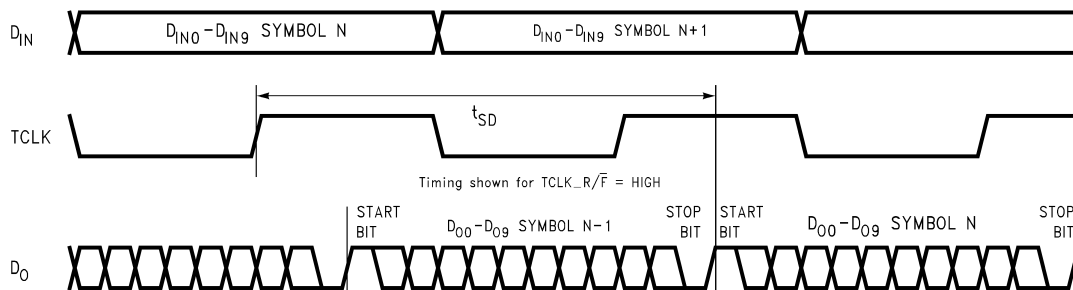
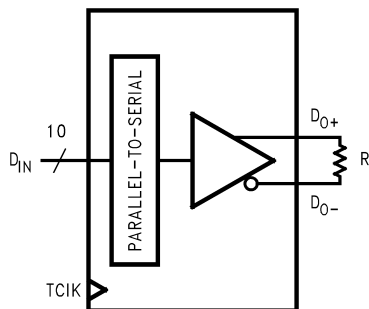

Figure 11. Serializer Delay



$V_{OD} = (DO^+) - (DO^-)$ .  
Differential output signal is shown as  $(DO^+) - (DO^-)$ , device in Data Transfer mode.

Figure 12.  $V_{OD}$  Diagram

## APPLICATION INFORMATION

### USING THE SERIALIZER AND DESERIALIZER CHIPSET

The Serializer and Deserializer chipset is an easy to use transmitter and receiver pair that sends 10 bits of parallel LVTTTL data over a serial Bus LVDS link up to 660 Mbps. An on-board PLL serializes the input data and embeds two clock bits within the data stream. The Deserializer uses a separate reference clock (REFCLK) and an onboard PLL to extract the clock information from the incoming data stream and then deserialize the data. The Deserializer monitors the incoming clock information, determines lock status, and asserts the  $\overline{\text{LOCK}}$  output high when loss of lock occurs.

### POWER CONSIDERATIONS

An all CMOS design of the Serializer and Deserializer makes them inherently low power devices. In addition, the constant current source nature of the Bus LVDS outputs minimizes the slope of the speed vs.  $I_{CC}$  curve of conventional CMOS designs.

### TRANSMITTING DATA

Once you power up the Serializer and Deserializer, they must be phase locked to each other to transmit data. Phase locking occurs when the Deserializer locks to incoming data or when the Serializer sends patterns. The Serializer sends SYNC patterns whenever the SYNC1 or SYNC2 inputs are high. The  $\overline{\text{LOCK}}$  output of the Deserializer remains high until it has locked to the incoming data stream. Connecting the  $\overline{\text{LOCK}}$  output of the Deserializer to one of the SYNC inputs of the Serializer will ensure that enough SYNC patterns are sent to achieve Deserializer lock.

The Deserializer can also lock to incoming data by simply powering up the device and allowing the “random lock” circuitry to find and lock to the data stream.

While the Deserializer  $\overline{\text{LOCK}}$  output is low, data at the Deserializer outputs (ROUT0-9) is valid, except for the specific case of loss of lock during transmission.

### HOT INSERTION

All the BLVDS devices are hot pluggable if you follow a few rules. When inserting, ensure the Ground pin(s) makes contact first, then the VCC pin(s), and then the I/O pins. When removing, the I/O pins should be unplugged first, then the VCC, then the Ground. Random lock hot insertion is illustrated in [Figure 13](#).

### PCB CONSIDERATIONS

The Bus LVDS Serializer and Deserializer should be placed as close to the edge connector as possible. In multiple Deserializer applications, the distance from the Deserializer to the slot connector appears as a stub to the Serializer driving the backplane traces. Longer stubs lower the impedance of the bus, increase the load on the Serializer, and lower the threshold margin at the Deserializers. Deserializer devices should be placed much less than one inch from slot connectors. Because transition times are very fast on the Serializer Bus LVDS outputs, reducing stub lengths as much as possible is the best method to ensure signal integrity.

### TRANSMISSION MEDIA

The Serializer and Deserializer can also be used in point-to-point configuration of a backplane, through a PCB trace, or through twisted pair cable. In point-to-point configuration, the transmission media need only be terminated at the receiver end. Please note that in point-to-point configuration, the potential of offsetting the ground levels of the Serializer vs. the Deserializer must be considered. Also, Bus LVDS provides a +/- 1.2V common mode range at the receiver inputs.

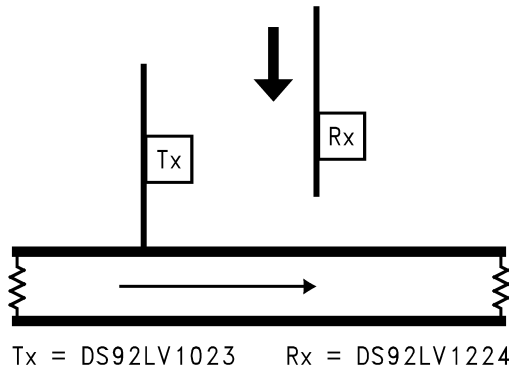

Figure 13. Random Lock Hot Insertion

Pin Diagram

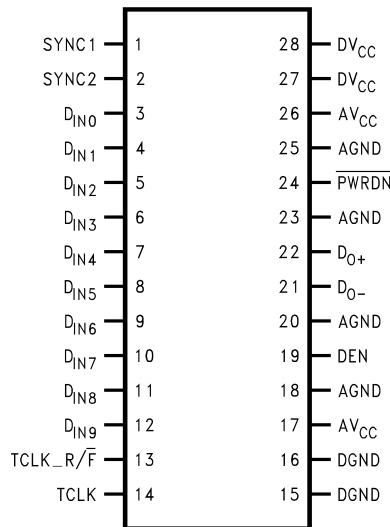

Figure 14. DS92LV1023TMSA - Serializer SSOP Package  
See Package Number DB0028A

SERIALIZER PIN DESCRIPTIONS

Pin Name	No.	I/O	Description
DIN	3–12	I	Data Input. LVTTTL levels inputs. Data on these pins are loaded into a 10-bit input register.
TCLK_R/ $\overline{\text{F}}$	13	I	Transmit Clock Rising/Falling strobe select. LVTTTL level input. Selects TCLK active edge for strobing of DIN data. High selects rising edge. Low selects falling edge.
DO+	22	O	+ Serial Data Output. Non-inverting Bus LVDS differential output.
DO-	21	O	- Serial Data Output. Inverting Bus LVDS differential output.
DEN	19	I	Serial Data Output Enable. LVTTTL level input. A low, puts the Bus LVDS outputs in TRI-STATE.
$\overline{\text{PWRDN}}$	24	I	Powerdown. LVTTTL level input. $\overline{\text{PWRDN}}$ driven low shuts down the PLL and TRI-STATEs outputs putting the device into a low power sleep mode.
TCLK	14	I	Transmit Clock. LVTTTL level input. Input for 40 MHz–66 MHz (nominal) system clock.
SYNC	1, 2	I	Assertion of SYNC (high) for at least 1024 synchronization symbols to be transmitted on the Bus LVDS serial output. Synchronization symbols continue to be sent if SYNC continues asserted. TTL level input. The two SYNC pins are ORed.
DVCC	27, 28	I	Digital Circuit power supply.
DGND	15, 16	I	Digital Circuit ground.

**SERIALIZER PIN DESCRIPTIONS (continued)**

Pin Name	No.	I/O	Description
AVCC	17, 26	I	Analog power supply (PLL and Analog Circuits).
AGND	18, 25, 20, 23	I	Analog ground (PLL and Analog Circuits).

---

**REVISION HISTORY**

<b>Changes from Revision C (April 2013) to Revision D</b>	<b>Page</b>
• Changed layout of National Data Sheet to TI format .....	<a href="#">12</a>

---

**PACKAGING INFORMATION**

Orderable Device	Status (1)	Package Type	Package Drawing	Pins	Package Qty	Eco Plan (2)	Lead/Ball Finish (6)	MSL Peak Temp (3)	Op Temp (°C)	Device Marking (4/5)	Samples
DS92LV1023TMSA	LIFEBUY	SSOP	DB	28	47	TBD	Call TI	Call TI		DS92LV1023T MSA	
DS92LV1023TMSA/NOPB	LIFEBUY	SSOP	DB	28	47	Green (RoHS & no Sb/Br)	CU SN	Level-3-260C-168 HR		DS92LV1023T MSA	
DS92LV1023TMSAX/NOPB	LIFEBUY	SSOP	DB	28	2000	Green (RoHS & no Sb/Br)	CU SN	Level-3-260C-168 HR		DS92LV1023T MSA	

(1) The marketing status values are defined as follows:

**ACTIVE:** Product device recommended for new designs.

**LIFEBUY:** TI has announced that the device will be discontinued, and a lifetime-buy period is in effect.

**NRND:** Not recommended for new designs. Device is in production to support existing customers, but TI does not recommend using this part in a new design.

**PREVIEW:** Device has been announced but is not in production. Samples may or may not be available.

**OBsolete:** TI has discontinued the production of the device.

(2) **RoHS:** TI defines "RoHS" to mean semiconductor products that are compliant with the current EU RoHS requirements for all 10 RoHS substances, including the requirement that RoHS substance do not exceed 0.1% by weight in homogeneous materials. Where designed to be soldered at high temperatures, "RoHS" products are suitable for use in specified lead-free processes. TI may reference these types of products as "Pb-Free".

**RoHS Exempt:** TI defines "RoHS Exempt" to mean products that contain lead but are compliant with EU RoHS pursuant to a specific EU RoHS exemption.

**Green:** TI defines "Green" to mean the content of Chlorine (Cl) and Bromine (Br) based flame retardants meet JS709B low halogen requirements of <=1000ppm threshold. Antimony trioxide based flame retardants must also meet the <=1000ppm threshold requirement.

(3) MSL, Peak Temp. - The Moisture Sensitivity Level rating according to the JEDEC industry standard classifications, and peak solder temperature.

(4) There may be additional marking, which relates to the logo, the lot trace code information, or the environmental category on the device.

(5) Multiple Device Markings will be inside parentheses. Only one Device Marking contained in parentheses and separated by a "-" will appear on a device. If a line is indented then it is a continuation of the previous line and the two combined represent the entire Device Marking for that device.

(6) Lead/Ball Finish - Orderable Devices may have multiple material finish options. Finish options are separated by a vertical ruled line. Lead/Ball Finish values may wrap to two lines if the finish value exceeds the maximum column width.

**Important Information and Disclaimer:** The information provided on this page represents TI's knowledge and belief as of the date that it is provided. TI bases its knowledge and belief on information provided by third parties, and makes no representation or warranty as to the accuracy of such information. Efforts are underway to better integrate information from third parties. TI has taken and continues to take reasonable steps to provide representative and accurate information but may not have conducted destructive testing or chemical analysis on incoming materials and chemicals. TI and TI suppliers consider certain information to be proprietary, and thus CAS numbers and other limited information may not be available for release.

In no event shall TI's liability arising out of such information exceed the total purchase price of the TI part(s) at issue in this document sold by TI to Customer on an annual basis.

## TAPE AND REEL INFORMATION



### QUADRANT ASSIGNMENTS FOR PIN 1 ORIENTATION IN TAPE



\*All dimensions are nominal

Device	Package Type	Package Drawing	Pins	SPQ	Reel Diameter (mm)	Reel Width W1 (mm)	A0 (mm)	B0 (mm)	K0 (mm)	P1 (mm)	W (mm)	Pin1 Quadrant
DS92LV1023TMSAX/NOPB	SSOP	DB	28	2000	330.0	16.4	8.4	10.7	2.4	12.0	16.0	Q1



TAPE AND REEL BOX DIMENSIONS



\*All dimensions are nominal

Device	Package Type	Package Drawing	Pins	SPQ	Length (mm)	Width (mm)	Height (mm)
DS92LV1023TMSAX/NOP B	SSOP	DB	28	2000	367.0	367.0	38.0

DB (R-PDSO-G\*\*)

PLASTIC SMALL-OUTLINE

28 PINS SHOWN



- NOTES: A. All linear dimensions are in millimeters.  
 B. This drawing is subject to change without notice.  
 C. Body dimensions do not include mold flash or protrusion not to exceed 0,15.  
 D. Falls within JEDEC MO-150

## IMPORTANT NOTICE

Texas Instruments Incorporated (TI) reserves the right to make corrections, enhancements, improvements and other changes to its semiconductor products and services per JESD46, latest issue, and to discontinue any product or service per JESD48, latest issue. Buyers should obtain the latest relevant information before placing orders and should verify that such information is current and complete.

TI's published terms of sale for semiconductor products (<http://www.ti.com/sc/docs/stdterms.htm>) apply to the sale of packaged integrated circuit products that TI has qualified and released to market. Additional terms may apply to the use or sale of other types of TI products and services.

Reproduction of significant portions of TI information in TI data sheets is permissible only if reproduction is without alteration and is accompanied by all associated warranties, conditions, limitations, and notices. TI is not responsible or liable for such reproduced documentation. Information of third parties may be subject to additional restrictions. Resale of TI products or services with statements different from or beyond the parameters stated by TI for that product or service voids all express and any implied warranties for the associated TI product or service and is an unfair and deceptive business practice. TI is not responsible or liable for any such statements.

Buyers and others who are developing systems that incorporate TI products (collectively, "Designers") understand and agree that Designers remain responsible for using their independent analysis, evaluation and judgment in designing their applications and that Designers have full and exclusive responsibility to assure the safety of Designers' applications and compliance of their applications (and of all TI products used in or for Designers' applications) with all applicable regulations, laws and other applicable requirements. Designer represents that, with respect to their applications, Designer has all the necessary expertise to create and implement safeguards that (1) anticipate dangerous consequences of failures, (2) monitor failures and their consequences, and (3) lessen the likelihood of failures that might cause harm and take appropriate actions. Designer agrees that prior to using or distributing any applications that include TI products, Designer will thoroughly test such applications and the functionality of such TI products as used in such applications.

TI's provision of technical, application or other design advice, quality characterization, reliability data or other services or information, including, but not limited to, reference designs and materials relating to evaluation modules, (collectively, "TI Resources") are intended to assist designers who are developing applications that incorporate TI products; by downloading, accessing or using TI Resources in any way, Designer (individually or, if Designer is acting on behalf of a company, Designer's company) agrees to use any particular TI Resource solely for this purpose and subject to the terms of this Notice.

TI's provision of TI Resources does not expand or otherwise alter TI's applicable published warranties or warranty disclaimers for TI products, and no additional obligations or liabilities arise from TI providing such TI Resources. TI reserves the right to make corrections, enhancements, improvements and other changes to its TI Resources. TI has not conducted any testing other than that specifically described in the published documentation for a particular TI Resource.

Designer is authorized to use, copy and modify any individual TI Resource only in connection with the development of applications that include the TI product(s) identified in such TI Resource. NO OTHER LICENSE, EXPRESS OR IMPLIED, BY ESTOPPEL OR OTHERWISE TO ANY OTHER TI INTELLECTUAL PROPERTY RIGHT, AND NO LICENSE TO ANY TECHNOLOGY OR INTELLECTUAL PROPERTY RIGHT OF TI OR ANY THIRD PARTY IS GRANTED HEREIN, including but not limited to any patent right, copyright, mask work right, or other intellectual property right relating to any combination, machine, or process in which TI products or services are used. Information regarding or referencing third-party products or services does not constitute a license to use such products or services, or a warranty or endorsement thereof. Use of TI Resources may require a license from a third party under the patents or other intellectual property of the third party, or a license from TI under the patents or other intellectual property of TI.

TI RESOURCES ARE PROVIDED "AS IS" AND WITH ALL FAULTS. TI DISCLAIMS ALL OTHER WARRANTIES OR REPRESENTATIONS, EXPRESS OR IMPLIED, REGARDING RESOURCES OR USE THEREOF, INCLUDING BUT NOT LIMITED TO ACCURACY OR COMPLETENESS, TITLE, ANY EPIDEMIC FAILURE WARRANTY AND ANY IMPLIED WARRANTIES OF MERCHANTABILITY, FITNESS FOR A PARTICULAR PURPOSE, AND NON-INFRINGEMENT OF ANY THIRD PARTY INTELLECTUAL PROPERTY RIGHTS. TI SHALL NOT BE LIABLE FOR AND SHALL NOT DEFEND OR INDEMNIFY DESIGNER AGAINST ANY CLAIM, INCLUDING BUT NOT LIMITED TO ANY INFRINGEMENT CLAIM THAT RELATES TO OR IS BASED ON ANY COMBINATION OF PRODUCTS EVEN IF DESCRIBED IN TI RESOURCES OR OTHERWISE. IN NO EVENT SHALL TI BE LIABLE FOR ANY ACTUAL, DIRECT, SPECIAL, COLLATERAL, INDIRECT, PUNITIVE, INCIDENTAL, CONSEQUENTIAL OR EXEMPLARY DAMAGES IN CONNECTION WITH OR ARISING OUT OF TI RESOURCES OR USE THEREOF, AND REGARDLESS OF WHETHER TI HAS BEEN ADVISED OF THE POSSIBILITY OF SUCH DAMAGES.

Unless TI has explicitly designated an individual product as meeting the requirements of a particular industry standard (e.g., ISO/TS 16949 and ISO 26262), TI is not responsible for any failure to meet such industry standard requirements.

Where TI specifically promotes products as facilitating functional safety or as compliant with industry functional safety standards, such products are intended to help enable customers to design and create their own applications that meet applicable functional safety standards and requirements. Using products in an application does not by itself establish any safety features in the application. Designers must ensure compliance with safety-related requirements and standards applicable to their applications. Designer may not use any TI products in life-critical medical equipment unless authorized officers of the parties have executed a special contract specifically governing such use. Life-critical medical equipment is medical equipment where failure of such equipment would cause serious bodily injury or death (e.g., life support, pacemakers, defibrillators, heart pumps, neurostimulators, and implantables). Such equipment includes, without limitation, all medical devices identified by the U.S. Food and Drug Administration as Class III devices and equivalent classifications outside the U.S.

TI may expressly designate certain products as completing a particular qualification (e.g., Q100, Military Grade, or Enhanced Product). Designers agree that it has the necessary expertise to select the product with the appropriate qualification designation for their applications and that proper product selection is at Designers' own risk. Designers are solely responsible for compliance with all legal and regulatory requirements in connection with such selection.

Designer will fully indemnify TI and its representatives against any damages, costs, losses, and/or liabilities arising out of Designer's non-compliance with the terms and provisions of this Notice.