

## TPS22929D Ultra-Small, Low on Resistance Load Switch With Controlled Turn-on

### 1 Features

- Integrated Single Load Switch
- Small SOT23-6 Package
- Input Voltage Range: 1.4 V to 5.5 V
- Low ON-Resistance
  - $r_{ON} = 115 \text{ m}\Omega$  at  $V_{IN} = 5 \text{ V}$
  - $r_{ON} = 115 \text{ m}\Omega$  at  $V_{IN} = 3.3 \text{ V}$
  - $r_{ON} = 118 \text{ m}\Omega$  at  $V_{IN} = 2.5 \text{ V}$
  - $r_{ON} = 129 \text{ m}\Omega$  at  $V_{IN} = 1.5 \text{ V}$
- 1.8-A Continuous Switch Current (25°C)
- Low Threshold Control Input
- Controlled Slew-rate
- Under-Voltage Lock Out
- Quick Output Discharge
- Reverse Current Protection

### 2 Applications

- Portable Industrial Equipment
- Portable Medical Equipment
- Portable Media Players
- Point Of Sales Terminal
- GPS Devices
- Digital Cameras
- Portable Instrumentation
- Smartphones

### 3 Description

The TPS22929D is a small, low  $r_{ON}$  load switch with controlled turn on. The device contains a P-channel MOSFET that can operate over an input voltage range of 1.4 V to 5.5 V. The switch is controlled by an on/off input (ON), which is capable of interfacing directly with low-voltage control signals. The TPS22929D is active high enable.

The TPS22929D contains a 150- $\Omega$  on-chip load resistor for quick output discharge when the switch is turned off. The rise time of the device is internally controlled in order to avoid inrush current.

The TPS22929D device provides circuit breaker functionality by latching off the power-switch during reverse voltage situations. An internal reverse voltage comparator disables the power-switch when the output voltage ( $V_{OUT}$ ) is driven higher than the input ( $V_{IN}$ ) to quickly (10  $\mu\text{s}$  typ) stop the flow of current towards the input side of the switch. Reverse current is always active, even when the power-switch is disabled. Additionally, under-voltage lockout (UVLO) protection turns the switch off if the input voltage is too low.

The TPS22929D is available in a small, space-saving 6-pin SOT23 package and is characterized for operation over the free-air temperature range of  $-40^\circ\text{C}$  to  $85^\circ\text{C}$ .

#### Device Information<sup>(1)</sup>

PART NUMBER	PACKAGE	BODY SIZE (NOM)
TPS22929D	SOT23 (6)	2.90 mm x 1.60 mm

(1) For all available packages, see the orderable addendum at the end of the datasheet.

### 4 Simplified Schematic

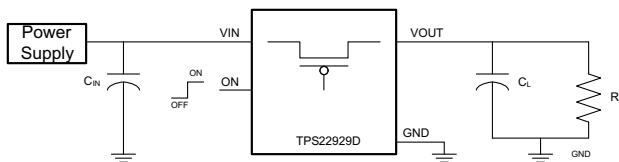

#### On-State Resistance vs Input Voltage

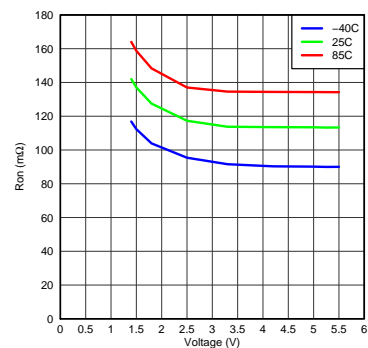

## Table of Contents

<b>1</b>	<b>Features</b> .....	<b>1</b>	9.1	Overview .....	<b>12</b>
<b>2</b>	<b>Applications</b> .....	<b>1</b>	9.2	Functional Block Diagram .....	<b>12</b>
<b>3</b>	<b>Description</b> .....	<b>1</b>	9.3	Feature Description .....	<b>12</b>
<b>4</b>	<b>Simplified Schematic</b> .....	<b>1</b>	9.4	Device Functional Modes .....	<b>13</b>
<b>5</b>	<b>Revision History</b> .....	<b>2</b>	<b>10</b>	<b>Application and Implementation</b> .....	<b>14</b>
<b>6</b>	<b>Pin Configuration and Functions</b> .....	<b>3</b>	10.1	Application Information .....	<b>14</b>
<b>7</b>	<b>Specifications</b> .....	<b>3</b>	10.2	Typical Application .....	<b>14</b>
7.1	Absolute Maximum Ratings .....	<b>3</b>	<b>11</b>	<b>Power Supply Recommendations</b> .....	<b>18</b>
7.2	Handling Ratings .....	<b>4</b>	<b>12</b>	<b>Layout</b> .....	<b>18</b>
7.3	Recommended Operating Conditions .....	<b>4</b>	12.1	Layout Guidelines .....	<b>18</b>
7.4	Thermal Information .....	<b>4</b>	12.2	Layout Example .....	<b>19</b>
7.5	Electrical Characteristics .....	<b>5</b>	<b>13</b>	<b>Device and Documentation Support</b> .....	<b>19</b>
7.6	Switching Characteristics .....	<b>6</b>	13.1	Trademarks .....	<b>19</b>
7.7	Typical Characteristics .....	<b>7</b>	13.2	Electrostatic Discharge Caution .....	<b>19</b>
<b>8</b>	<b>Parametric Measurement Information</b> .....	<b>10</b>	13.3	Glossary .....	<b>19</b>
<b>9</b>	<b>Detailed Description</b> .....	<b>12</b>	<b>14</b>	<b>Mechanical, Packaging, and Orderable Information</b> .....	<b>19</b>

## 5 Revision History

### Changes from Original (December 2011) to Revision A

**Page**

• Updated to enhanced datasheet standards .....	<b>1</b>
• Added Handling Ratings table. ....	<b>4</b>
• Added Thermal Information table. ....	<b>4</b>
• Added Detailed Description section. ....	<b>12</b>
• Added Application and Implementation section. ....	<b>14</b>
• Added Power Supply Recommendations section. ....	<b>18</b>
• Added Layout section. ....	<b>18</b>

## 6 Pin Configuration and Functions

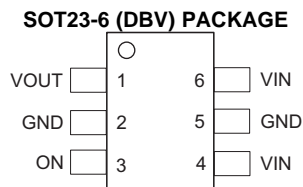

### Pin Functions

PIN		DESCRIPTION
NAME	DBV	
GND	2, 5	Ground
ON	3	Switch control input, active high. Do not leave floating
VOUT	1	Switch output
VIN	4, 6	Switch input, bypass this input with a ceramic capacitor to ground

## 7 Specifications

### 7.1 Absolute Maximum Ratings

over operating free-air temperature range (unless otherwise noted)

		MIN	MAX	UNIT
$V_{IN}$	Input voltage range	-0.3	6	V
$V_{OUT}$	Output voltage range	-0.3	6	V
$V_{ON}$	Input voltage range	-0.3	6	V
$P_{MAX}$	Maximum continuous power dissipation at 25°C		463	mW
	Maximum continuous power dissipation at 70°C		254	
	Maximum continuous power dissipation at 85°C		185	
$I_{MAX}$	Maximum continuous operating current		2	A
$T_A$	Operating free-air temperature range	-40	85	°C
$T_J$	Maximum junction temperature		125	°C

## 7.2 Handling Ratings

		MIN	MAX	UNIT
$T_{stg}$	Storage temperature range	-65	150	°C
$V_{(ESD)}$	Electrostatic discharge	Human body model (HBM), per ANSI/ESDA/JEDEC JS-001, all pins <sup>(1)</sup>		kV
		Charged device model (CDM), per JEDEC specification JESD22-C101, all pins <sup>(2)</sup>		
		-2	2	
		-1	1	

- (1) JEDEC document JEP155 states that 500-V HBM allows safe manufacturing with a standard ESD control process. Pins listed as 2 kV may actually have higher performance.
- (2) JEDEC document JEP157 states that 250-V CDM allows safe manufacturing with a standard ESD control process. Pins listed as 1 kV may actually have higher performance.

## 7.3 Recommended Operating Conditions

		MIN	MAX	UNIT
$V_{IN}$	Input voltage range	1.4	5.5	V
$V_{ON}$	ON voltage range	0	5.5	V
$V_{OUT}$	Output voltage range		$V_{IN}$	
$V_{IH}$	High-level input voltage, ON	$V_{IN} = 1.4 \text{ V to } 5.5 \text{ V}$		V
$V_{IL}$	Low-level input voltage, ON	$V_{IN} = 3.61 \text{ V to } 5.5 \text{ V}$		0.6
		$V_{IN} = 1.4 \text{ V to } 3.6 \text{ V}$		0.4
$C_{IN}$	Input Capacitor	1 <sup>(1)</sup>		μF

- (1) Refer to the application section.

## 7.4 Thermal Information

THERMAL METRIC <sup>(1)</sup>		TPS22929D	UNITS
		DBV	
		6 PINS	
$R_{\theta JA}$	Junction-to-ambient thermal resistance	216	°C/W
$R_{\theta Jctop}$	Junction-to-case (top) thermal resistance	209	
$R_{\theta JB}$	Junction-to-board thermal resistance	131	
$\Psi_{JT}$	Junction-to-top characterization parameter	52	
$\Psi_{JB}$	Junction-to-board characterization parameter	110	

- (1) For more information about traditional and new thermal metrics, see the *IC Package Thermal Metrics* application report, [SPRA953](#).

## 7.5 Electrical Characteristics

VIN = 1.4 V to 5.5 V, TA = –40°C to 85°C (unless otherwise noted)

PARAMETER	TEST CONDITIONS	TA	MIN	TYP	MAX	UNIT							
I <sub>IN</sub>	Quiescent current	Full			I <sub>OUT</sub> = 0, V <sub>IN</sub> = V <sub>ON</sub> = 5.25 V	2.2	10	μA					
					I <sub>OUT</sub> = 0, V <sub>IN</sub> = V <sub>ON</sub> = 4.2 V	2.1	7.0						
					I <sub>OUT</sub> = 0, V <sub>IN</sub> = V <sub>ON</sub> = 3.6 V	2.0	7.0						
					I <sub>OUT</sub> = 0, V <sub>IN</sub> = V <sub>ON</sub> = 2.5 V	1.0	5.0						
					I <sub>OUT</sub> = 0, V <sub>IN</sub> = V <sub>ON</sub> = 1.5 V	0.8	5.0						
I <sub>IN(off)</sub>	Off supply current	Full			V <sub>ON</sub> = GND, V <sub>OUT</sub> = Open, V <sub>IN</sub> = 5.25 V	0.8	10	μA					
					V <sub>ON</sub> = GND, V <sub>OUT</sub> = Open, V <sub>IN</sub> = 4.2 V	0.3	7.0						
					V <sub>ON</sub> = GND, V <sub>OUT</sub> = Open, V <sub>IN</sub> = 3.6 V	0.2	7.0						
					V <sub>ON</sub> = GND, V <sub>OUT</sub> = Open, V <sub>IN</sub> = 2.5 V	0.2	5.0						
					V <sub>ON</sub> = GND, V <sub>OUT</sub> = Open, V <sub>IN</sub> = 1.5 V	0.1	5.0						
I <sub>IN(Leakage)</sub>	Leakage current	Full			V <sub>ON</sub> = GND, V <sub>OUT</sub> = 0, V <sub>IN</sub> = 5.25 V	0.8	10	μA					
					V <sub>ON</sub> = GND, V <sub>OUT</sub> = 0, V <sub>IN</sub> = 4.2 V	0.3	7.0						
					V <sub>ON</sub> = GND, V <sub>OUT</sub> = 0, V <sub>IN</sub> = 3.6 V	0.2	7.0						
					V <sub>ON</sub> = GND, V <sub>OUT</sub> = 0, V <sub>IN</sub> = 2.5 V	0.2	5.0						
					V <sub>ON</sub> = GND, V <sub>OUT</sub> = 0, V <sub>IN</sub> = 1.5 V	0.1	5.0						
r <sub>ON</sub>	On-resistance	25°C	Full			V <sub>IN</sub> = 5.25 V, I <sub>OUT</sub> = –200 mA	115	150	mΩ				
						V <sub>IN</sub> = 5.0 V, I <sub>OUT</sub> = –200 mA	115	150					
		25°C	Full				V <sub>IN</sub> = 4.2 V, I <sub>OUT</sub> = –200 mA	115		150			
							V <sub>IN</sub> = 3.3 V, I <sub>OUT</sub> = –200 mA	115		150			
		25°C	Full				V <sub>IN</sub> = 2.5 V, I <sub>OUT</sub> = –200 mA	118		155			
							V <sub>IN</sub> = 1.5 V, I <sub>OUT</sub> = –200 mA	129		170			
		25°C	Full					175		200			
								175		200			
		25°C											
		RPD	Output pull down resistance					V <sub>IN</sub> = 3.3 V, V <sub>ON</sub> = 0, I <sub>OUT</sub> = 30 mA		25°C	150	200	Ω
		UVLO	Under voltage lockout	Full				V <sub>IN</sub> increasing, V <sub>ON</sub> = 3.6 V, I <sub>OUT</sub> = –100 mA				1.4	V
								V <sub>IN</sub> decreasing, V <sub>ON</sub> 3.6 V, R <sub>L</sub> = 10 Ω		0.50			
I <sub>ON</sub>	ON input leakage current	Full				V <sub>ON</sub> = 1.4 V to 5.25 V or GND			1	μA			
V <sub>RVP</sub>	Reverse Current Voltage Threshold							77		mV			
t <sub>DELAY</sub>	Reverse Current Response Delay					V <sub>IN</sub> = 5V		10		μs			

## 7.6 Switching Characteristics

PARAMETER		TEST CONDITION	TPS22929D	UNIT
			TYP	
<b>VIN = 5 V, TA = 25°C (unless otherwise noted)</b>				
t <sub>ON</sub>	Turn-ON time	R <sub>L</sub> = 10 Ω, C <sub>L</sub> = 0.1 μF	3315	μs
t <sub>OFF</sub>	Turn-OFF time	R <sub>L</sub> = 10 Ω, C <sub>L</sub> = 0.1 μF	7.4	
t <sub>R</sub>	VOUT rise time	R <sub>L</sub> = 10 Ω, C <sub>L</sub> = 0.1 μF	3660	
t <sub>F</sub>	VOUT fall time	R <sub>L</sub> = 10 Ω, C <sub>L</sub> = 0.1 μF	6.1	
<b>VIN = 3.3 V, TA = 25°C (unless otherwise noted)</b>				
t <sub>ON</sub>	Turn-ON time	R <sub>L</sub> = 10 Ω, C <sub>L</sub> = 0.1 μF	4655	μs
t <sub>OFF</sub>	Turn-OFF time	R <sub>L</sub> = 10 Ω, C <sub>L</sub> = 0.1 μF	9.5	
t <sub>R</sub>	VOUT rise time	R <sub>L</sub> = 10 Ω, C <sub>L</sub> = 0.1 μF	4150	
t <sub>F</sub>	VOUT fall time	R <sub>L</sub> = 10 Ω, C <sub>L</sub> = 0.1 μF	3.0	
<b>VIN = 1.5 V, TA = 25°C (unless otherwise noted)</b>				
t <sub>ON</sub>	Turn-ON time	R <sub>L</sub> = 10 Ω, C <sub>L</sub> = 0.1 μF	10175	μs
t <sub>OFF</sub>	Turn-OFF time	R <sub>L</sub> = 10 Ω, C <sub>L</sub> = 0.1 μF	18.3	
t <sub>R</sub>	VOUT rise time	R <sub>L</sub> = 10 Ω, C <sub>L</sub> = 0.1 μF	7812	
t <sub>F</sub>	VOUT fall time	R <sub>L</sub> = 10 Ω, C <sub>L</sub> = 0.1 μF	3.0	

## 7.7 Typical Characteristics

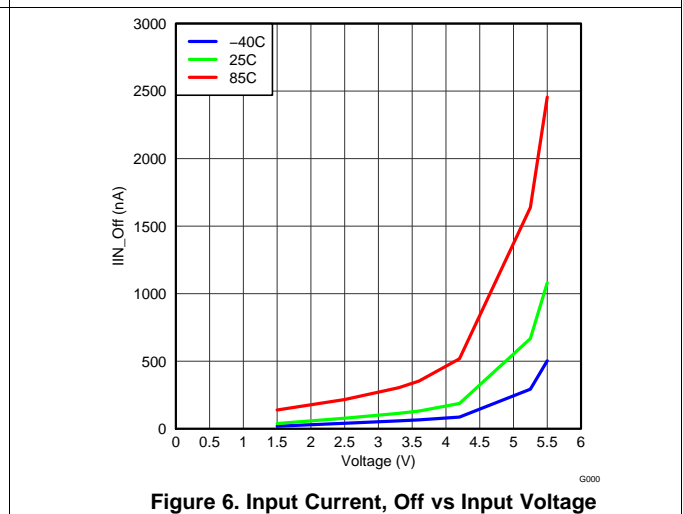
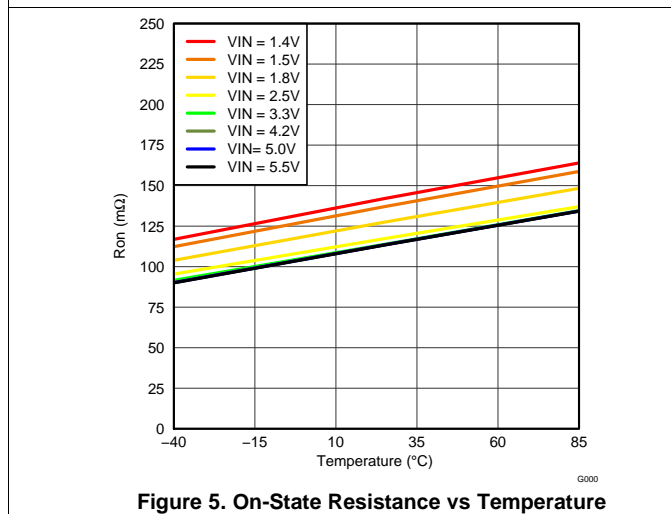
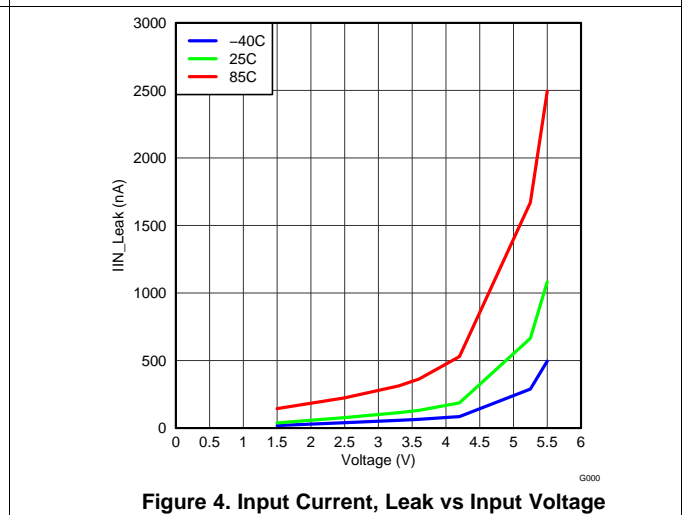
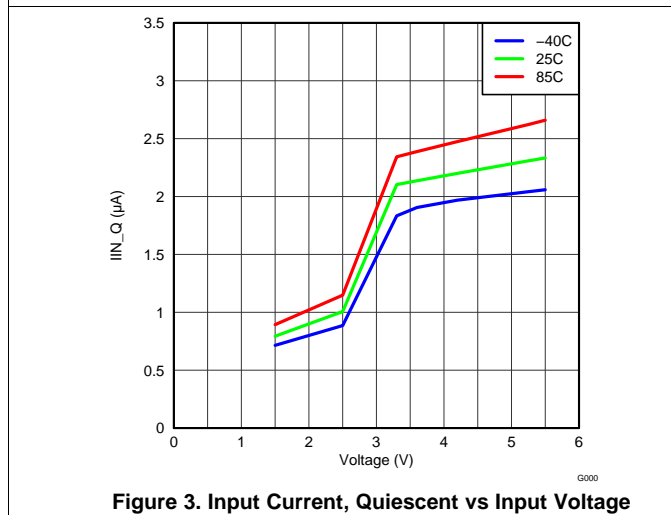
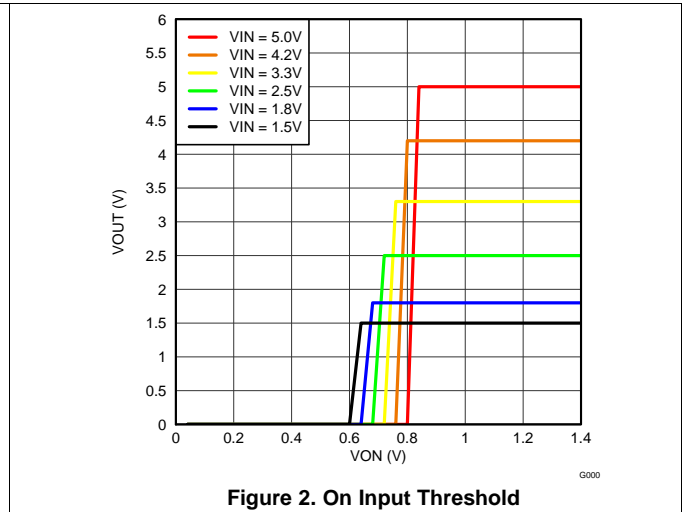
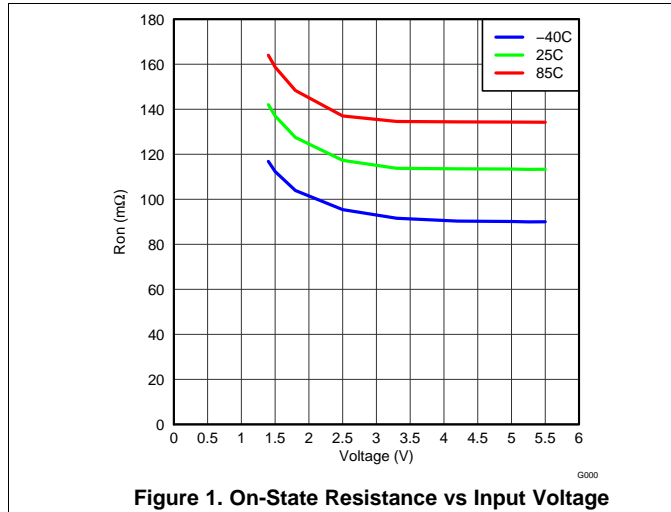

Typical Characteristics (continued)

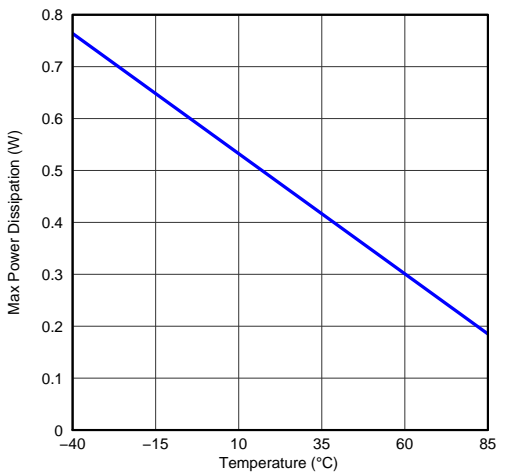

Figure 7. Allowable Power Dissipation

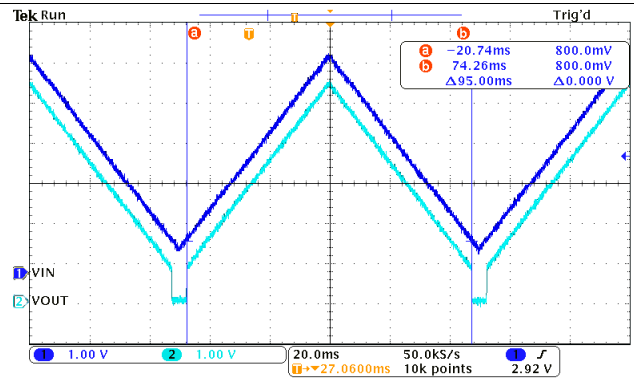

Figure 8. Under-Voltage Lockout Response (IOUT = -100mA)

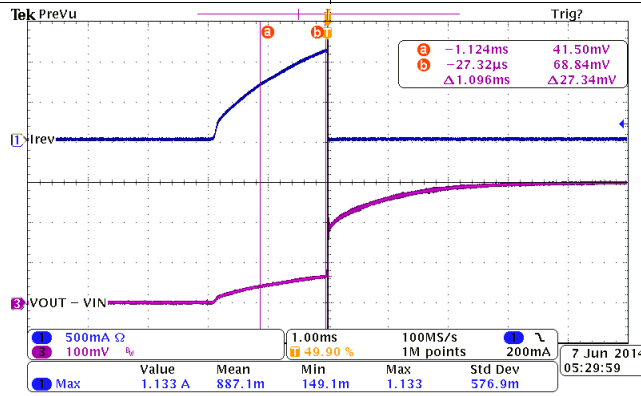

Figure 9. Reverse Current Protection (VIN = 3.0 V, VOUT Ramp up From 3.0 V to 3.3 V)



7.7.1 Typical AC Characteristics

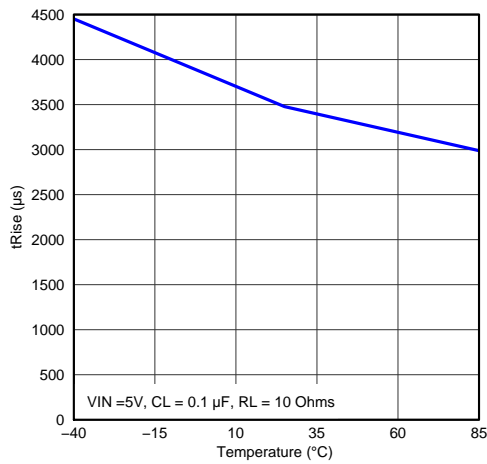

Figure 10. Rise Time vs Temperature

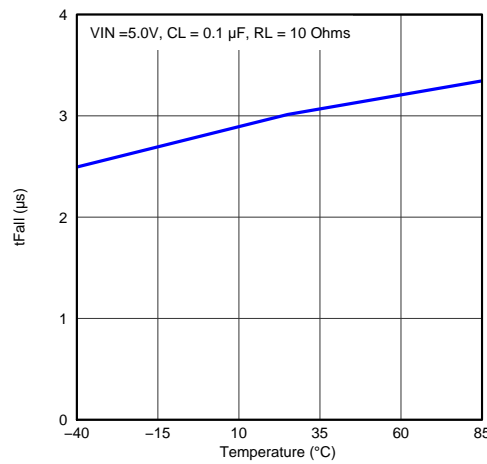

Figure 11. Fall Time vs Temperature

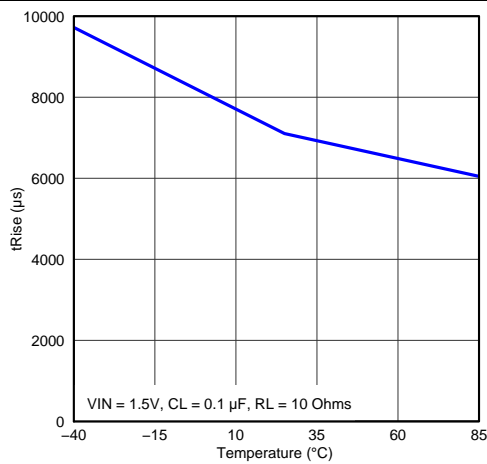

Figure 12. Rise Time vs Temperature

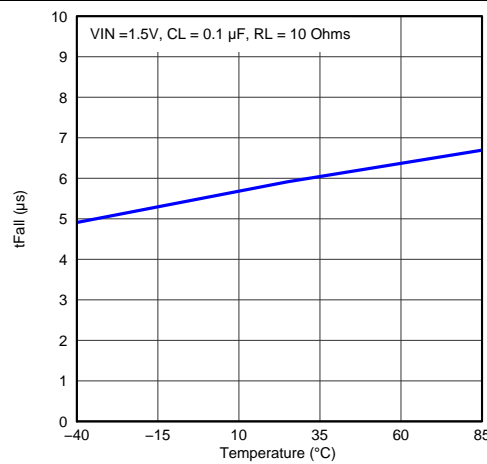

Figure 13. Fall Time vs Temperature

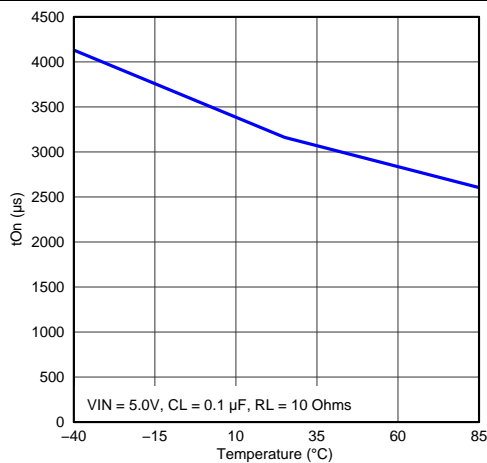

Figure 14. Turn-On Time vs Temperature

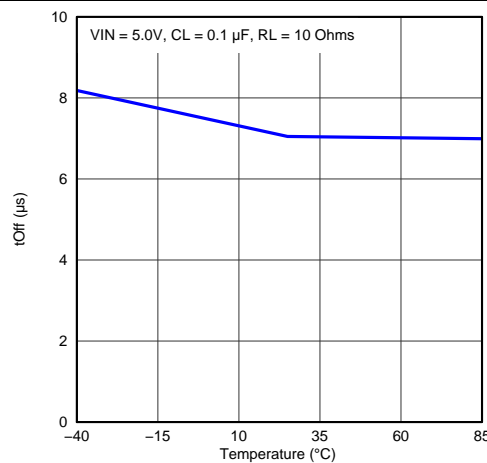

Figure 15. Turn-Off Time vs Temperature

Typical AC Characteristics (continued)

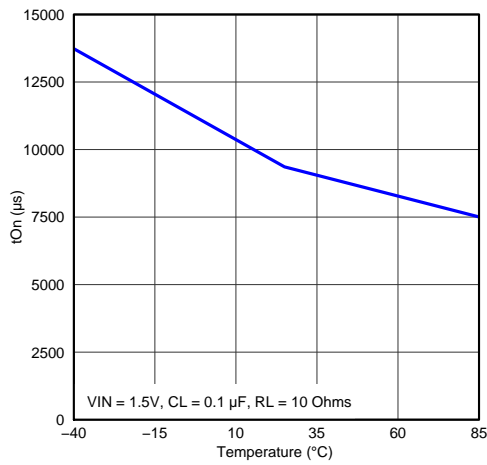

Figure 16. Turn-On Time vs Temperature

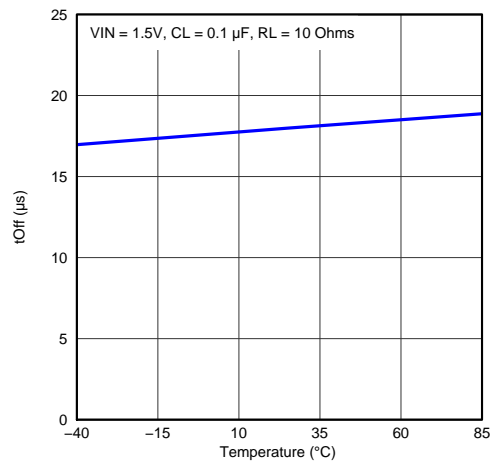

Figure 17. Turn-Off Time vs Temperature

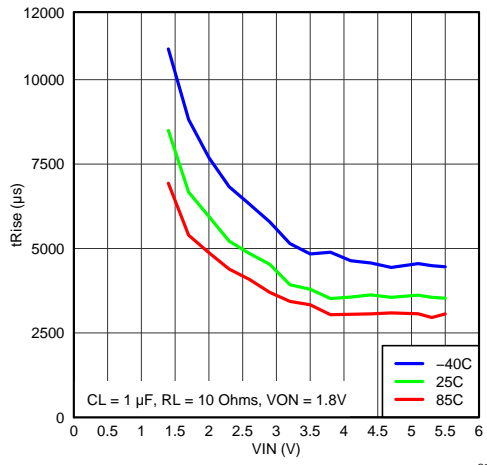

Figure 18. Rise Time vs Input Voltage

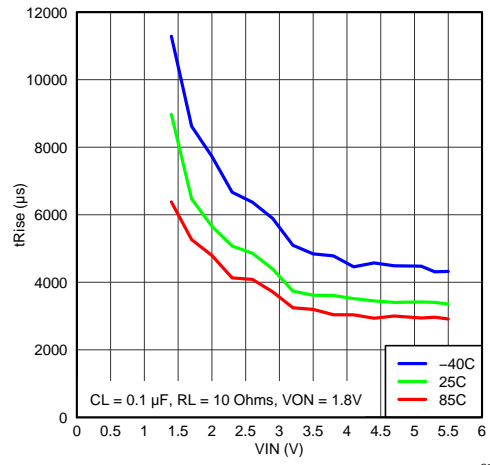
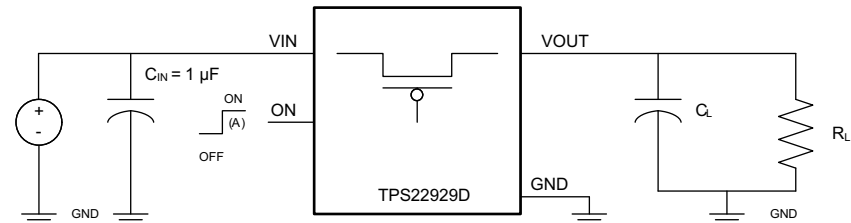

Figure 19. Rise Time vs Input Voltage

8 Parametric Measurement Information



A. Rise and fall times of the control signal is 100 ns.

Figure 20. Test Circuit

**Parametric Measurement Information (continued)**

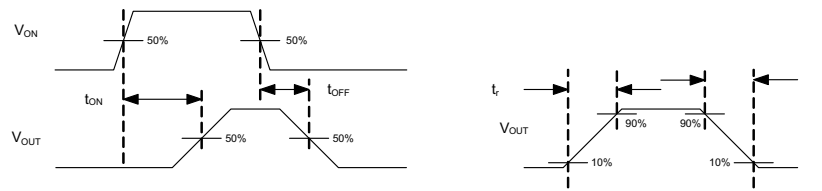

**Figure 21.  $T_{ON}/T_{OFF}$  Waveforms**

## 9 Detailed Description

### 9.1 Overview

The TPS22929D is a single channel, 1.8-A load switch in a small, space-saving 6-pin SOT23-6 package. This device implements a low resistance P-channel MOSFET with a controlled rise time for applications that need to limit the inrush current.

This device is also designed to have very low leakage current during off state. This prevents downstream circuits from pulling high standby current from the supply. Integrated control logic, driver, power supply, and output discharge FET eliminates the need for additional external components, which reduces solution size and bill of materials (BOM) count.

### 9.2 Functional Block Diagram

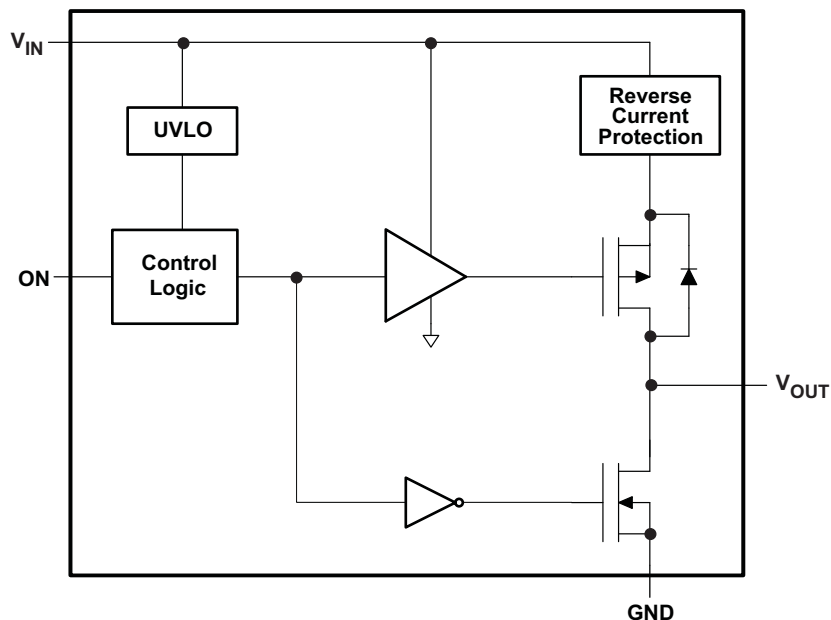

### 9.3 Feature Description

#### 9.3.1 On/Off Control

The ON pin controls the state of the switch. Asserting ON high enables the switch. ON is active high and has a low threshold, making it capable of interfacing with low-voltage signals. The ON pin is compatible with standard GPIO logic threshold. It can be used with any microcontroller with 1.2-V, 1.8-V, 2.5-V or 3.3-V GPIOs.

#### 9.3.2 Output Pull-Down

The output pull-down is active when the user is turning off the main pass FET. The pull-down discharges the output rail to approximately 10% of the rail, and then the output pull-down is automatically disconnected to optimize the shutdown current.

#### 9.3.3 Under-Voltage Lockout

The under-voltage lockout turns-off the switch if the input voltage drops below the under-voltage lockout threshold. During under-voltage lockout (UVLO), if the voltage level at  $V_{OUT}$  exceeds the voltage level at  $V_{IN}$  by the Reverse Current Voltage Threshold ( $V_{RVP}$ ), the body diode will be disengaged to prevent any current flow to  $V_{IN}$ . With the ON pin active the input voltage rising above the under-voltage lockout threshold will cause a controlled turn-on of the switch which limits current over-shoots.

## Feature Description (continued)

### 9.3.4 Reverse Current Protection

In a scenario where  $V_{OUT}$  is greater than  $V_{IN}$ , there is potential for reverse current through the pass FET or the body diode. The TPS22929D monitors  $V_{IN}$  and  $V_{OUT}$  voltage levels. When the reverse current voltage threshold ( $V_{RVP}$ ) is exceeded, the switch is disabled (within 10  $\mu$ s typ). Additionally, the body diode is disengaged so as to prevent any reverse current flow to  $V_{IN}$ . The FET, and the output ( $V_{OUT}$ ), will resume normal operation when the reverse voltage scenario is no longer present.

Use the following formula to calculate the amount of reverse current required to activate the protection circuit for a particular application:

$$I_{RC} = \frac{0.077V}{R_{ON(VIN)}}$$

Where,

$I_{RC}$  is the amount of reverse current,

$R_{ON(VIN)}$  is the on-resistance as determined by the input voltage.

## 9.4 Device Functional Modes

**Table 1. Function Table**

ON	VIN to VOUT	VOUT to GND <sup>(1)</sup>
L	OFF	ON
H	ON	OFF

(1) See [Output Pull-Down](#) section.

## 10 Application and Implementation

### 10.1 Application Information

#### 10.1.1 VIN to VOUT Voltage Drop

The VIN to VOUT voltage drop in the device is determined by the  $R_{ON}$  of the device and the load current. The  $R_{ON}$  of the device depends upon the VIN condition of the device. Refer to the  $R_{ON}$  specification of the device in the Electrical Characteristics table of this datasheet. Once the  $R_{ON}$  of the device is determined based upon the VIN conditions, use [Equation 1](#) to calculate the VIN to VOUT voltage drop:

$$\Delta V = I_{LOAD} \times R_{ON} \quad (1)$$

Where,

$\Delta V$  = Voltage drop from VIN to VOUT

$I_{LOAD}$  = Load current

$R_{ON}$  = On-resistance of the device for a specific  $V_{IN}$

An appropriate  $I_{LOAD}$  must be chosen such that the  $I_{MAX}$  specification of the device is not violated.

#### 10.1.2 Input Capacitor

To limit the voltage drop on the input supply caused by transient inrush currents, when the switch turns on into a discharged load capacitor or short-circuit, a capacitor needs to be placed between VIN and GND. A 1- $\mu$ F ceramic capacitor,  $C_{IN}$ , placed close to the pins is usually sufficient. Higher values of  $C_{IN}$  can be used to further reduce the voltage drop.

#### 10.1.3 Output Capacitor

A  $C_{IN}$  to  $C_L$  ratio of 10 to 1 is recommended for minimizing  $V_{IN}$  dip caused by inrush currents during startup.

## 10.2 Typical Application

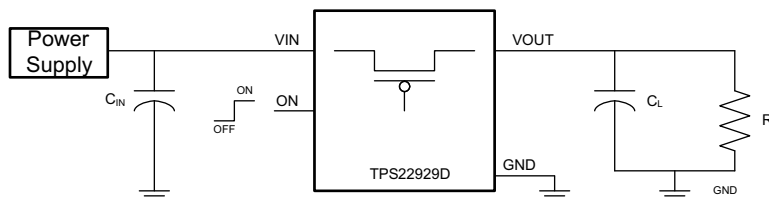

**Figure 22. Typical Application Schematic**

### 10.2.1 Design Requirements

Design Parameter	Example Value
VIN	1.5 V to 5 V
CL	0.1 $\mu$ F to 1 $\mu$ F
Maximum Acceptable Inrush Current	10 mA

## 10.2.2 Detailed Design Procedure

### 10.2.2.1 Managing Inrush Current

When the switch is enabled, the output capacitors must be charged up from 0-V to VIN voltage. This charge arrives in the form of inrush current. Inrush current can be calculated using the following equation:

$$\text{Inrush Current} = C \times \frac{dv}{dt} \quad (2)$$

Where,

C = Output capacitance

$\frac{dv}{dt}$  = Output slew rate

The TPS22929D offers a very slow controlled rise time for minimizing inrush current. This device can be selected based upon the maximum acceptable slew rate which can be calculated using the design requirements and the inrush current equation. An output capacitance of 1.0  $\mu\text{F}$  will be used since the amount of inrush increases with output capacitance:

$$10 \text{ mA} = 1.0 \mu\text{F} \times \frac{dv}{dt} \quad (3)$$

$$\frac{dv}{dt} = 10 \text{ V/ms} \quad (4)$$

To ensure an inrush current of less than 10 mA, a device with a slew rate less than 10 V/ms must be used.

The TPS22929D has a typical rise time of 4500  $\mu\text{s}$  at 3.3 V . This results in a slew rate of 733 mV/ms which meets the above design requirements.

### 10.2.3 Application Curves

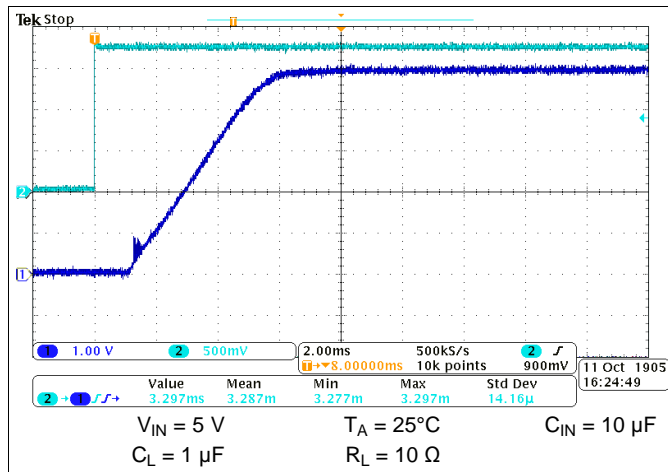

Figure 23. Turn-On Response

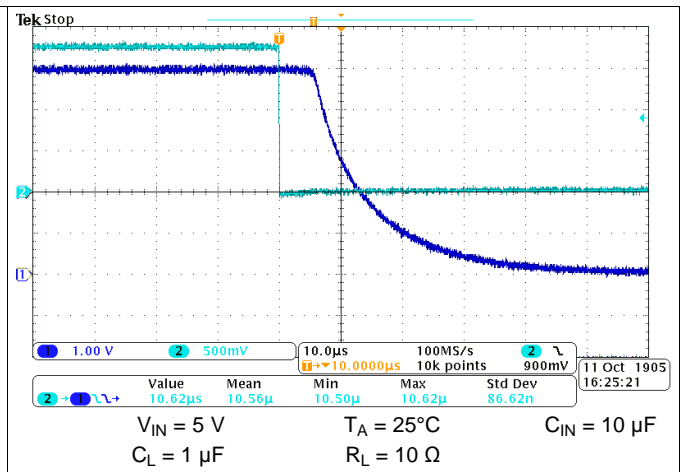

Figure 24. Turn-Off Response

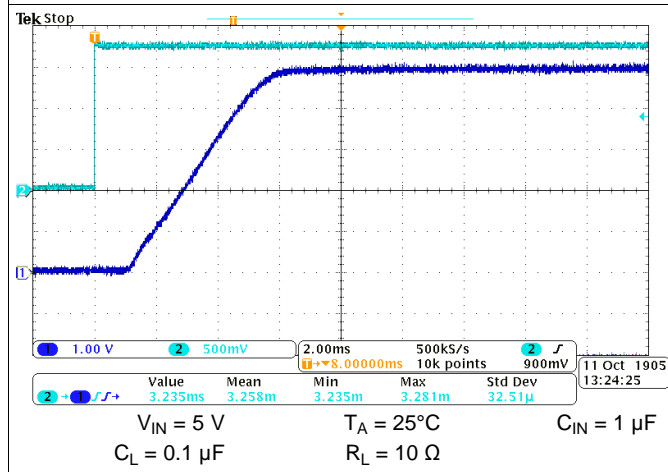

Figure 25. Turn-On Response Time

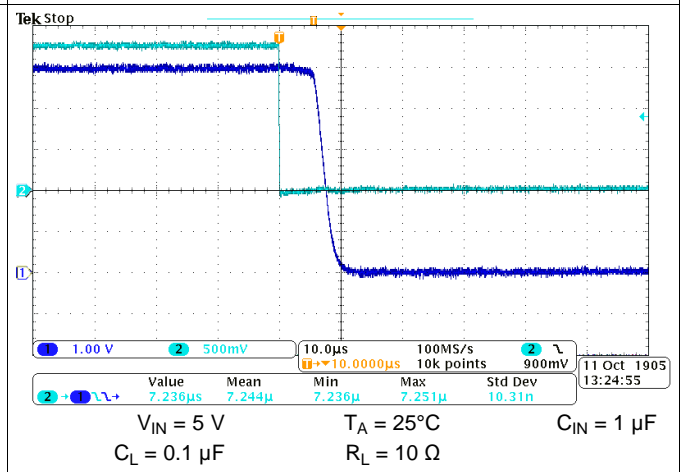

Figure 26. Turn-Off Response Time

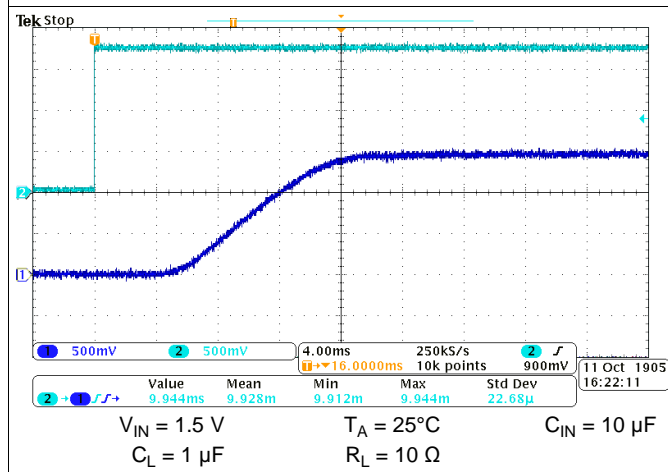

Figure 27. Turn-On Response Time

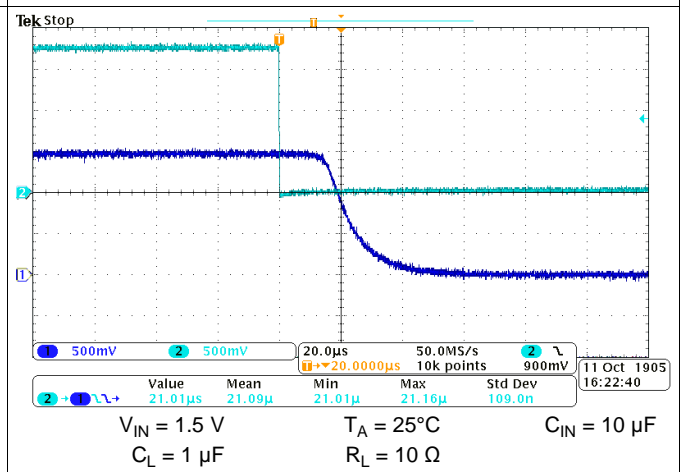
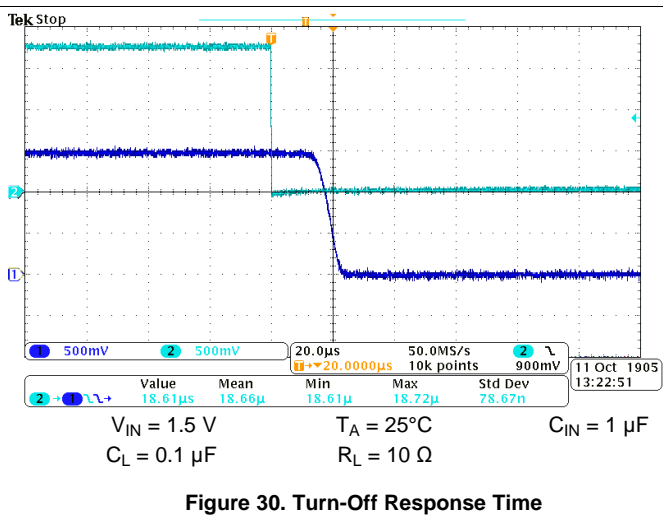
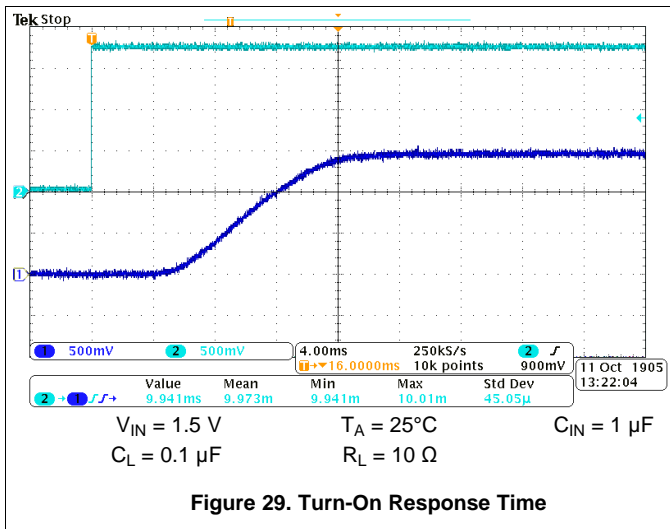

Figure 28. Turn-Off Response Time





## 11 Power Supply Recommendations

The device is designed to operate with a VIN range of 1.4 V to 5.5 V.

## 12 Layout

### 12.1 Layout Guidelines

For best performance, all traces should be as short as possible. To be most effective, the input and output capacitors should be placed close to the device to minimize the effects that parasitic trace inductances may have on normal operation. Using wide traces for VIN, VOUT, and GND helps minimize the parasitic electrical effects along with minimizing the case to ambient thermal impedance.

#### 12.1.1 Thermal Considerations

For best device performance, be sure to follow the thermal guidelines in the [Thermal Information](#) table. To calculate max allowable continuous current for your application for a specific VIN and ambient temperature, use the following formula:

$$I_{MAX} = \sqrt{\frac{T_J - T_A}{\theta_{JA} R_{ON}}}$$

Where:

I<sub>MAX</sub>= Max allowable continuous current

T<sub>J</sub>= Max thermal junction temperature (125°C)

T<sub>A</sub>= Ambient temperature of the application

θ<sub>JA</sub>= Junction-to-air thermal impedance (216°C/W)

R<sub>ON</sub>= R<sub>ON</sub> at a specified input voltage VIN (see [Electrical Characteristics](#))

## 12.2 Layout Example

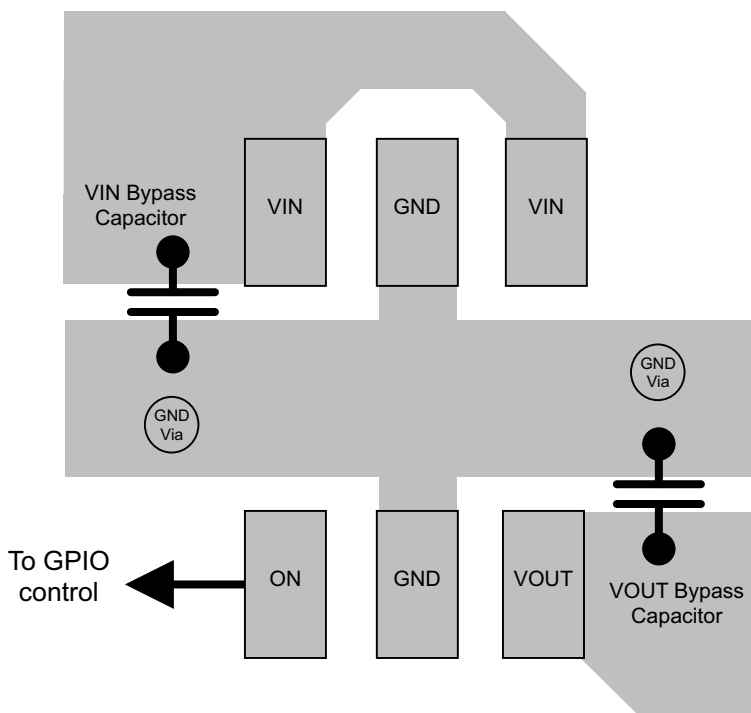

Figure 31. Layout Drawing

## 13 Device and Documentation Support

### 13.1 Trademarks

All trademarks are the property of their respective owners.

### 13.2 Electrostatic Discharge Caution



These devices have limited built-in ESD protection. The leads should be shorted together or the device placed in conductive foam during storage or handling to prevent electrostatic damage to the MOS gates.

### 13.3 Glossary

[SLYZ022](#) — *TI Glossary*.

This glossary lists and explains terms, acronyms, and definitions.

## 14 Mechanical, Packaging, and Orderable Information

The following pages include mechanical, packaging, and orderable information. This information is the most current data available for the designated devices. This data is subject to change without notice and revision of this document. For browser-based versions of this data sheet, refer to the left-hand navigation.

**PACKAGING INFORMATION**

Orderable Device	Status (1)	Package Type	Package Drawing	Pins	Package Qty	Eco Plan (2)	Lead/Ball Finish (6)	MSL Peak Temp (3)	Op Temp (°C)	Device Marking (4/5)	Samples
TPS22929DDBVR	ACTIVE	SOT-23	DBV	6	3000	Green (RoHS & no Sb/Br)	CU NIPDAU	Level-1-260C-UNLIM	-40 to 85	NF4F	<a href="#">Samples</a>
TPS22929DDBVT	ACTIVE	SOT-23	DBV	6	250	Green (RoHS & no Sb/Br)	CU NIPDAU	Level-1-260C-UNLIM	-40 to 85	NF4F	<a href="#">Samples</a>

(1) The marketing status values are defined as follows:

**ACTIVE:** Product device recommended for new designs.

**LIFEBUY:** TI has announced that the device will be discontinued, and a lifetime-buy period is in effect.

**NRND:** Not recommended for new designs. Device is in production to support existing customers, but TI does not recommend using this part in a new design.

**PREVIEW:** Device has been announced but is not in production. Samples may or may not be available.

**OBSOLETE:** TI has discontinued the production of the device.

(2) Eco Plan - The planned eco-friendly classification: Pb-Free (RoHS), Pb-Free (RoHS Exempt), or Green (RoHS & no Sb/Br) - please check <http://www.ti.com/productcontent> for the latest availability information and additional product content details.

**TBD:** The Pb-Free/Green conversion plan has not been defined.

**Pb-Free (RoHS):** TI's terms "Lead-Free" or "Pb-Free" mean semiconductor products that are compatible with the current RoHS requirements for all 6 substances, including the requirement that lead not exceed 0.1% by weight in homogeneous materials. Where designed to be soldered at high temperatures, TI Pb-Free products are suitable for use in specified lead-free processes.

**Pb-Free (RoHS Exempt):** This component has a RoHS exemption for either 1) lead-based flip-chip solder bumps used between the die and package, or 2) lead-based die adhesive used between the die and leadframe. The component is otherwise considered Pb-Free (RoHS compatible) as defined above.

**Green (RoHS & no Sb/Br):** TI defines "Green" to mean Pb-Free (RoHS compatible), and free of Bromine (Br) and Antimony (Sb) based flame retardants (Br or Sb do not exceed 0.1% by weight in homogeneous material)

(3) MSL, Peak Temp. - The Moisture Sensitivity Level rating according to the JEDEC industry standard classifications, and peak solder temperature.

(4) There may be additional marking, which relates to the logo, the lot trace code information, or the environmental category on the device.

(5) Multiple Device Markings will be inside parentheses. Only one Device Marking contained in parentheses and separated by a "~" will appear on a device. If a line is indented then it is a continuation of the previous line and the two combined represent the entire Device Marking for that device.

(6) Lead/Ball Finish - Orderable Devices may have multiple material finish options. Finish options are separated by a vertical ruled line. Lead/Ball Finish values may wrap to two lines if the finish value exceeds the maximum column width.

**Important Information and Disclaimer:** The information provided on this page represents TI's knowledge and belief as of the date that it is provided. TI bases its knowledge and belief on information provided by third parties, and makes no representation or warranty as to the accuracy of such information. Efforts are underway to better integrate information from third parties. TI has taken and continues to take reasonable steps to provide representative and accurate information but may not have conducted destructive testing or chemical analysis on incoming materials and chemicals. TI and TI suppliers consider certain information to be proprietary, and thus CAS numbers and other limited information may not be available for release.

In no event shall TI's liability arising out of such information exceed the total purchase price of the TI part(s) at issue in this document sold by TI to Customer on an annual basis.

## TAPE AND REEL INFORMATION



### QUADRANT ASSIGNMENTS FOR PIN 1 ORIENTATION IN TAPE



\*All dimensions are nominal

Device	Package Type	Package Drawing	Pins	SPQ	Reel Diameter (mm)	Reel Width W1 (mm)	A0 (mm)	B0 (mm)	K0 (mm)	P1 (mm)	W (mm)	Pin1 Quadrant
TPS22929DDBVR	SOT-23	DBV	6	3000	178.0	9.0	3.23	3.17	1.37	4.0	8.0	Q3
TPS22929DDBVT	SOT-23	DBV	6	250	178.0	9.0	3.23	3.17	1.37	4.0	8.0	Q3

**TAPE AND REEL BOX DIMENSIONS**



\*All dimensions are nominal

Device	Package Type	Package Drawing	Pins	SPQ	Length (mm)	Width (mm)	Height (mm)
TPS22929DDBVR	SOT-23	DBV	6	3000	180.0	180.0	18.0
TPS22929DDBVT	SOT-23	DBV	6	250	180.0	180.0	18.0

# MECHANICAL DATA

DBV (R-PDSO-G6)

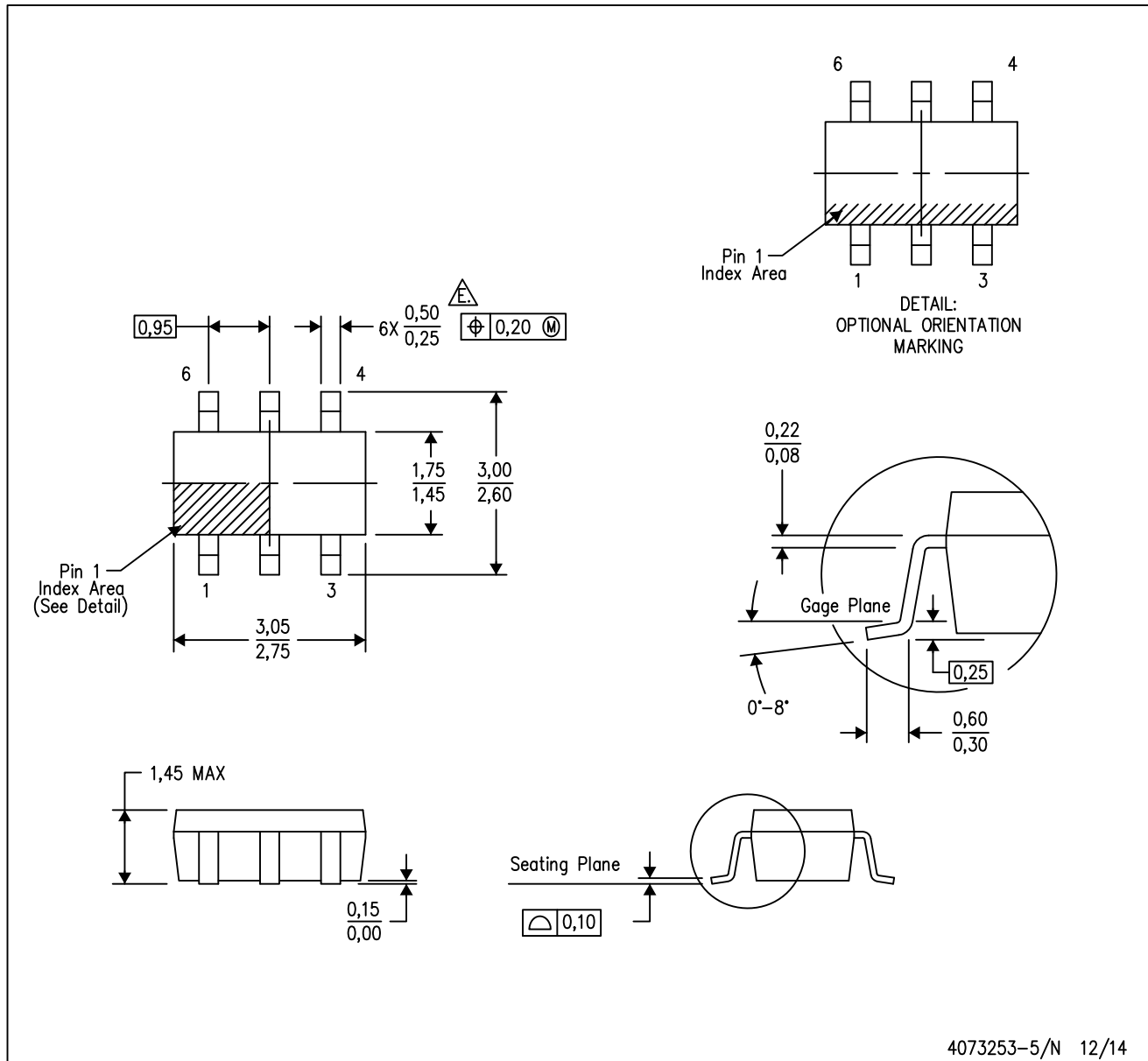
PLASTIC SMALL-OUTLINE PACKAGE



- NOTES:
- A. All linear dimensions are in millimeters.
  - B. This drawing is subject to change without notice.
  - C. Body dimensions do not include mold flash or protrusion. Mold flash and protrusion shall not exceed 0.15 per side.
  - D. Leads 1,2,3 may be wider than leads 4,5,6 for package orientation.
-  Falls within JEDEC MO-178 Variation AB, except minimum lead width.



DBV (R-PDSO-G6)

PLASTIC SMALL OUTLINE

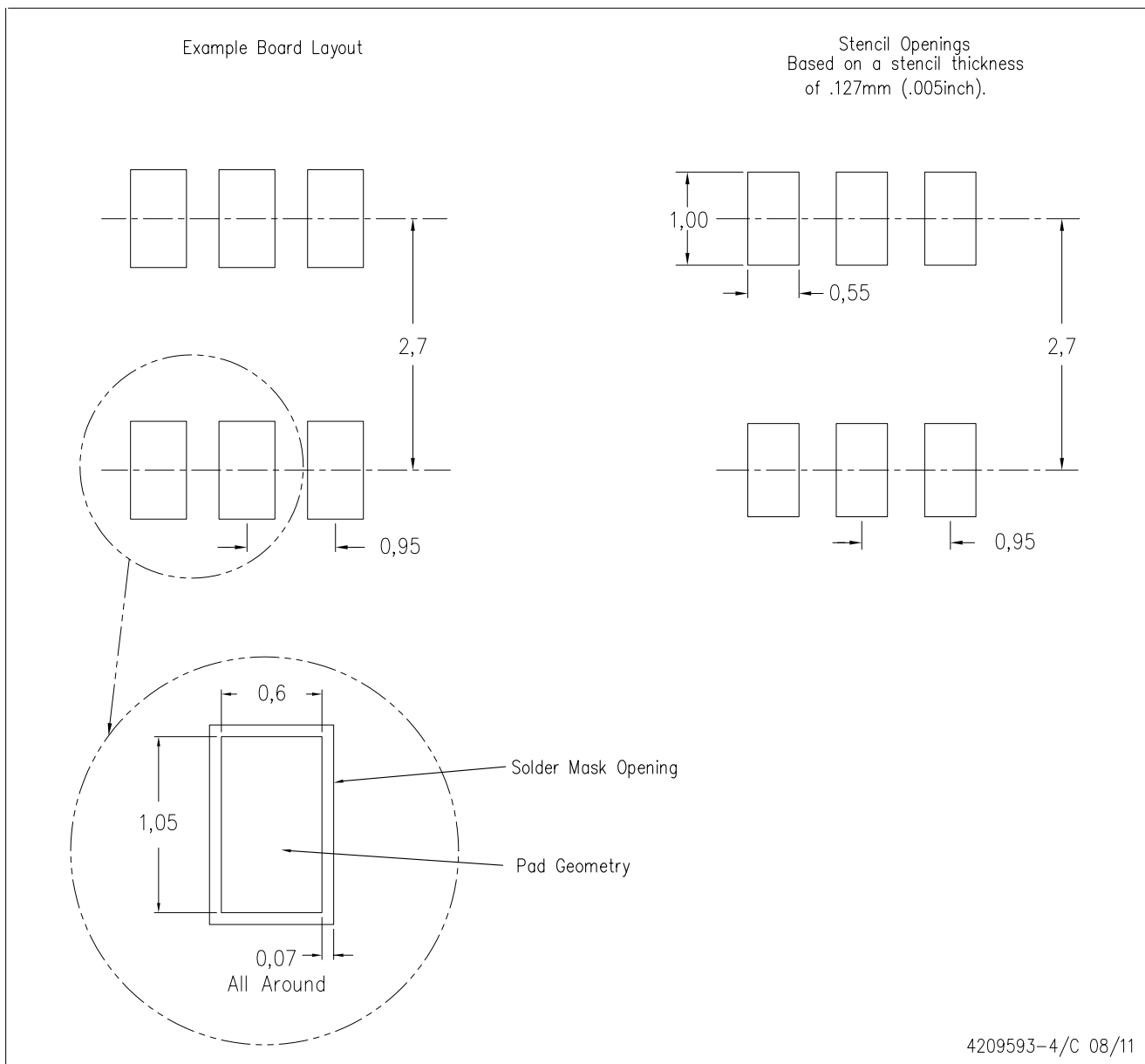

- NOTES:
- A. All linear dimensions are in millimeters.
  - B. This drawing is subject to change without notice.
  - C. Customers should place a note on the circuit board fabrication drawing not to alter the center solder mask defined pad.
  - D. Publication IPC-7351 is recommended for alternate designs.
  - E. Laser cutting apertures with trapezoidal walls and also rounding corners will offer better paste release. Customers should contact their board assembly site for stencil design recommendations. Example stencil design based on a 50% volumetric metal load solder paste. Refer to IPC-7525 for other stencil recommendations.

## IMPORTANT NOTICE

Texas Instruments Incorporated and its subsidiaries (TI) reserve the right to make corrections, enhancements, improvements and other changes to its semiconductor products and services per JESD46, latest issue, and to discontinue any product or service per JESD48, latest issue. Buyers should obtain the latest relevant information before placing orders and should verify that such information is current and complete. All semiconductor products (also referred to herein as "components") are sold subject to TI's terms and conditions of sale supplied at the time of order acknowledgment.

TI warrants performance of its components to the specifications applicable at the time of sale, in accordance with the warranty in TI's terms and conditions of sale of semiconductor products. Testing and other quality control techniques are used to the extent TI deems necessary to support this warranty. Except where mandated by applicable law, testing of all parameters of each component is not necessarily performed.

TI assumes no liability for applications assistance or the design of Buyers' products. Buyers are responsible for their products and applications using TI components. To minimize the risks associated with Buyers' products and applications, Buyers should provide adequate design and operating safeguards.

TI does not warrant or represent that any license, either express or implied, is granted under any patent right, copyright, mask work right, or other intellectual property right relating to any combination, machine, or process in which TI components or services are used. Information published by TI regarding third-party products or services does not constitute a license to use such products or services or a warranty or endorsement thereof. Use of such information may require a license from a third party under the patents or other intellectual property of the third party, or a license from TI under the patents or other intellectual property of TI.

Reproduction of significant portions of TI information in TI data books or data sheets is permissible only if reproduction is without alteration and is accompanied by all associated warranties, conditions, limitations, and notices. TI is not responsible or liable for such altered documentation. Information of third parties may be subject to additional restrictions.

Resale of TI components or services with statements different from or beyond the parameters stated by TI for that component or service voids all express and any implied warranties for the associated TI component or service and is an unfair and deceptive business practice. TI is not responsible or liable for any such statements.

Buyer acknowledges and agrees that it is solely responsible for compliance with all legal, regulatory and safety-related requirements concerning its products, and any use of TI components in its applications, notwithstanding any applications-related information or support that may be provided by TI. Buyer represents and agrees that it has all the necessary expertise to create and implement safeguards which anticipate dangerous consequences of failures, monitor failures and their consequences, lessen the likelihood of failures that might cause harm and take appropriate remedial actions. Buyer will fully indemnify TI and its representatives against any damages arising out of the use of any TI components in safety-critical applications.

In some cases, TI components may be promoted specifically to facilitate safety-related applications. With such components, TI's goal is to help enable customers to design and create their own end-product solutions that meet applicable functional safety standards and requirements. Nonetheless, such components are subject to these terms.

No TI components are authorized for use in FDA Class III (or similar life-critical medical equipment) unless authorized officers of the parties have executed a special agreement specifically governing such use.

Only those TI components which TI has specifically designated as military grade or "enhanced plastic" are designed and intended for use in military/aerospace applications or environments. Buyer acknowledges and agrees that any military or aerospace use of TI components which have **not** been so designated is solely at the Buyer's risk, and that Buyer is solely responsible for compliance with all legal and regulatory requirements in connection with such use.

TI has specifically designated certain components as meeting ISO/TS16949 requirements, mainly for automotive use. In any case of use of non-designated products, TI will not be responsible for any failure to meet ISO/TS16949.

### Products

Audio	<a href="http://www.ti.com/audio">www.ti.com/audio</a>
Amplifiers	<a href="http://amplifier.ti.com">amplifier.ti.com</a>
Data Converters	<a href="http://dataconverter.ti.com">dataconverter.ti.com</a>
DLP® Products	<a href="http://www.dlp.com">www.dlp.com</a>
DSP	<a href="http://dsp.ti.com">dsp.ti.com</a>
Clocks and Timers	<a href="http://www.ti.com/clocks">www.ti.com/clocks</a>
Interface	<a href="http://interface.ti.com">interface.ti.com</a>
Logic	<a href="http://logic.ti.com">logic.ti.com</a>
Power Mgmt	<a href="http://power.ti.com">power.ti.com</a>
Microcontrollers	<a href="http://microcontroller.ti.com">microcontroller.ti.com</a>
RFID	<a href="http://www.ti-rfid.com">www.ti-rfid.com</a>
OMAP Applications Processors	<a href="http://www.ti.com/omap">www.ti.com/omap</a>
Wireless Connectivity	<a href="http://www.ti.com/wirelessconnectivity">www.ti.com/wirelessconnectivity</a>

### Applications

Automotive and Transportation	<a href="http://www.ti.com/automotive">www.ti.com/automotive</a>
Communications and Telecom	<a href="http://www.ti.com/communications">www.ti.com/communications</a>
Computers and Peripherals	<a href="http://www.ti.com/computers">www.ti.com/computers</a>
Consumer Electronics	<a href="http://www.ti.com/consumer-apps">www.ti.com/consumer-apps</a>
Energy and Lighting	<a href="http://www.ti.com/energy">www.ti.com/energy</a>
Industrial	<a href="http://www.ti.com/industrial">www.ti.com/industrial</a>
Medical	<a href="http://www.ti.com/medical">www.ti.com/medical</a>
Security	<a href="http://www.ti.com/security">www.ti.com/security</a>
Space, Avionics and Defense	<a href="http://www.ti.com/space-avionics-defense">www.ti.com/space-avionics-defense</a>
Video and Imaging	<a href="http://www.ti.com/video">www.ti.com/video</a>

### TI E2E Community

[e2e.ti.com](http://e2e.ti.com)