

Low Noise, High Gain

# Monolithic Amplifier

PMA3-63GLN+

50Ω 1.8 to 6.0 GHz

## The Big Deal

- Flat gain over wideband
- Low noise figure, 0.6 dB typ.
- High Gain, up to 29.7 dB typ.



CASE STYLE: DQ1225

## Product Overview

The PMA3-63GLN+ is a PHEMT based wideband, low noise MMIC amplifier with a unique combination of low noise, high IP3, and flat gain over wideband making it ideal for sensitive, high-dynamic-range S-band receiver applications. This design operates on a single 5V supply, is well matched for 50Ω and comes in a tiny, low profile package (3 x 3 x 0.89mm), accommodating dense circuit board layouts.

## Key Features

Feature	Advantages
Low noise, 0.6 dB at 2.5 GHz	Enables lower system noise figure performance.
Wide bandwidth with flat gain • ±1.6 dB over 2.5 to 5 GHz	Enables a single amplifier to be used in many wideband applications including defense, instrumentation and more.
High Gain, 29.7 dB at 2.5 GHz	Enables signal amplification without the need for multiple gain stage. Thus minimize effect of subsequent stages on noise figure.
High IP3 • +28.6 dBm at 2.5 GHz	Combination of low noise and high IP3 makes this MMIC amplifier ideal for use in low noise receiver front end (RFE) as it gives the user advantages of sensitivity and two-tone IM performance at both ends of the dynamic range.
3 x 3mm 12-lead MCLP package	Tiny footprint saves space in dense layouts while providing low inductance, repeatable transitions, and excellent thermal contact to the PCB.



Low Noise, High Gain

# Monolithic Amplifier

1.8-6.0 GHz

## Product Features

- Low Noise figure, 0.6 dB typ.
- High IP3, 28.6 dBm typ.
- Excellent Gain flatness,  $\pm 1.6$  dB over 2.5 to 5 GHz
- High Gain, 29.7 dB typ.



Generic photo used for illustration purposes only

## PMA3-63GLN+

CASE STYLE: DQ1225

## Typical Applications

- 5G
- WiFi
- WLAN
- UMTS
- LTE
- WiMAX
- S-band Radar
- C-band Satcom

**+RoHS Compliant**

The +Suffix identifies RoHS Compliance. See our web site for RoHS Compliance methodologies and qualifications

## General Description

The PMA3-63GLN+ is a PHEMT based wideband, low noise MMIC amplifier with a unique combination of low noise, high IP3, and flat gain over wideband making it ideal for sensitive, high-dynamic-range S-band receiver applications. This design operates on a single 5V supply, is well matched for 50Ω and comes in a tiny, low profile package (3 x 3 x 0.89mm), accommodating dense circuit board layouts.

## Simplified schematic & pad description

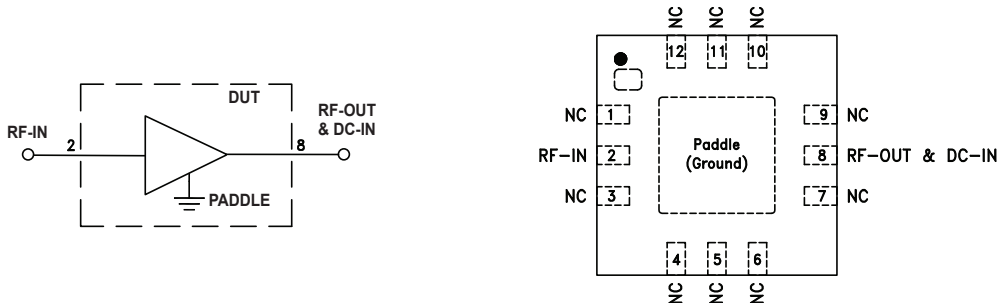

Function	Pad Number	Description (See Figure 1)
RF-IN	2	Connects to RF input via C1
RF-OUT & DC-IN	8	Connects to RF output via C2 and $V_{DD}$ via L1
Ground	Paddle	Connects to ground
No Connection	1,3 to 7, 9 to 12	Not used internally. Connected to ground on test board

Electrical Specifications<sup>1</sup> at 25°C and 5V, unless noted

Parameter	Condition (GHz)	V <sub>DD</sub> =5.0V			Units
		Min.	Typ.	Max.	
Frequency Range		1.8		6.0	GHz
Noise Figure	1.8	—	0.8	—	dB
	2.5	—	0.6	—	
	3.5	—	0.7	1.5	
	5	—	0.9	—	
	6	—	1.1	—	
Gain	1.8	28.5	31.7	34.8	dB
	2.5	—	29.7	—	
	3.5	25	27.9	30.6	
	5	—	26.5	—	
	6	22	24.9	26.9	
Input Return Loss	1.8	—	7	—	dB
	2.5	—	10	—	
	3.5	—	11	—	
	5	—	10	—	
	6	—	12	—	
Output Return Loss	1.8	—	10	—	dB
	2.5	—	10	—	
	3.5	—	10	—	
	5	—	16	—	
	6	—	22	—	
Output Power at 1dB Compression	1.8	—	15.2	—	dBm
	2.5	—	14.8	—	
	3.5	12.4	14.1	—	
	5	—	11.5	—	
	6	—	10.7	—	
Output IP3	1.8	—	28.8	—	dBm
	2.5	—	28.6	—	
	3.5	22.1	26.6	—	
	5	—	23.4	—	
	6	—	22.3	—	
Device Operating Voltage (V <sub>DD</sub> )			5.0		V
Device Operating Current (I <sub>DD</sub> )		—	69	80	mA
Device Current Variation vs. Temperature <sup>2</sup>			-26.9		μA/°C
Device Current Variation vs. Voltage			0.006		mA/mV
Thermal Resistance, junction-to-ground lead			57.3		°C/W

1. Measured on Mini-Circuits Characterization test board TB-PMA3-63GLN+ with tested board loss being deducted. See Characterization Test Circuit (Fig. 1)

2. (Current at 85°C - Current at -45°C)/130

Absolute Maximum Ratings<sup>3</sup>

Parameter	Ratings
Operating Temperature (ground lead)	-40°C to 85°C
Storage Temperature	-65°C to 150°C
Junction Temperature	150°C
Total Power Dissipation	1.0W
Input Power (CW), V <sub>d</sub> =5V	+29 dBm (5 minutes max.) +10 dBm (continuous)
DC Voltage	8.5V

3. Permanent damage may occur if any of these limits are exceeded.  
Electrical maximum ratings are not intended for continuous normal operation.



**Recommended Application and Characterization Test Circuit**

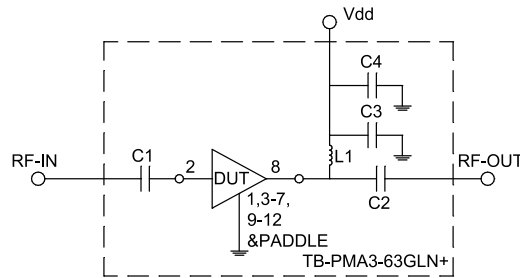

Component	Size	Value	P/N	Manufacturer
C1	0402	22pF	GRM1555C1H220JA01	Murata
C2	0402	22pF	GRM1555C1H220JA01	Murata
C3	0402	100pF	GRM1555C1H101JA01	Murata
C4	1206	22uF	GRM31CR61H106KA12	Murata
L1	0402	10nH	LQG15HSIONJD2	Murata

Fig 1. Application and Characterization Circuit

Note: This block diagram is used for characterization. (DUT soldered on Mini-Circuits Characterization test board TB-PMA3-63GLN+) Gain, Return loss, Output power at 1dB compression (P1 dB), output IP3 (OIP3) and noise figure measured using Agilent's N5242A PNA-X microwave network analyzer.

Conditions:

1. Gain and Return loss: Pin= -35dBm
2. Output IP3 (OIP3): Two tones, spaced 1 MHz apart, 0 dBm/tone at output.

**Product Marking**



Marking may contain other features or characters for internal lot control

<b>Additional Detailed Technical Information</b> <i>additional information is available on our dash board. To access this information <a href="#">click here</a></i>	
<b>Performance Data</b>	Data Table
	Swept Graphs
	S-Parameter (S2P Files) Data Set (.zip file)
<b>Case Style</b>	DQ1225 <i>Plastic package, exposed paddle, lead finish: Matte Tin</i>
<b>Tape &amp; Reel</b> Standard quantities available on reel	F66 <i>7" reels with 20, 50, 100, 200, 500, 1K or 2K devices</i>
<b>Suggested Layout for PCB Design</b>	PL-611
<b>Evaluation Board</b>	TB-PMA3-63GLN+
<b>Environmental Ratings</b>	ENV08T1

**ESD Rating**

Human Body Model (HBM): Class 1C (1000 to <2000V) in accordance with ANSI/ESD STM 5.1 - 2001

**MSL Test Flow Chart**

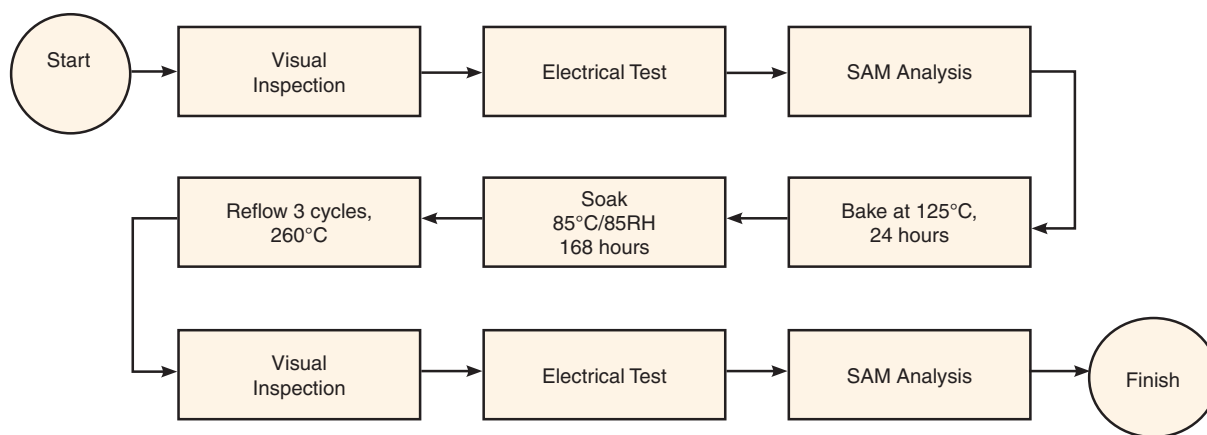

**Additional Notes**

- A. Performance and quality attributes and conditions not expressly stated in this specification document are intended to be excluded and do not form a part of this specification document.
- B. Electrical specifications and performance data contained in this specification document are based on Mini-Circuit's applicable established test performance criteria and measurement instructions.
- C. The parts covered by this specification document are subject to Mini-Circuits standard limited warranty and terms and conditions (collectively, "Standard Terms"); Purchasers of this part are entitled to the rights and benefits contained therein. For a full statement of the Standard Terms and the exclusive rights and remedies thereunder, please visit Mini-Circuits' website at [www.minicircuits.com/MCLStore/terms.jsp](http://www.minicircuits.com/MCLStore/terms.jsp)

## Typical Performance Data

### Definitions:

Input Return Loss = -S11 (dB)

Gain(Power Gain) = S21 (dB)

Reverse Isolation = -S12 (dB)

Output Return Loss = -S22 (dB)

TEST CONDITIONS: Vd = 5.00V, Id = 68mA @ Temperature = +25°C

FREQ	Gain	Isolation	Input Return Loss	Output Return Loss	Stability		IP-3 Output	1dB Comp. Output	Noise Figure
					K	Measure			
(MHz)	(dB)	(dB)	(dB)	(dB)	K	Measure	(dBm)	(dBm)	(dB)
1000	28.96	52.36	3.95	17.77	4.35	1.38	24.83	13.28	1.87
1100	30.17	49.93	3.89	17.90	2.90	1.37	25.66	14.05	1.58
1200	31.06	50.25	3.97	15.68	2.72	1.35	26.81	14.41	1.40
1300	31.61	48.01	4.16	13.71	2.08	1.29	27.06	14.57	1.22
1400	31.91	45.64	4.51	12.28	1.61	1.22	27.77	14.88	1.11
1500	32.01	44.30	4.92	11.39	1.44	1.15	28.17	15.25	0.99
1600	31.99	45.26	5.39	10.76	1.64	1.12	28.44	15.44	0.90
1700	31.81	43.30	5.93	10.41	1.43	1.05	28.49	15.28	0.84
1800	31.62	43.07	6.47	10.21	1.45	1.03	28.73	15.17	0.78
1900	31.36	41.74	6.97	10.16	1.37	0.98	28.97	15.32	0.72
2000	31.11	43.55	7.44	10.07	1.68	1.00	29.10	15.39	0.68
2100	30.83	42.11	7.87	10.09	1.53	0.97	29.28	15.06	0.69
2200	30.55	40.72	8.40	10.15	1.41	0.93	29.09	15.15	0.61
2300	30.29	40.83	8.76	10.16	1.48	0.93	29.42	15.50	0.63
2400	30.02	40.80	9.14	10.25	1.53	0.93	28.97	15.30	0.62
2500	29.76	39.29	9.49	10.29	1.39	0.89	28.67	14.82	0.59
2600	29.52	39.60	9.75	10.35	1.46	0.90	28.17	14.76	0.63
2700	29.27	40.10	10.02	10.37	1.58	0.91	28.06	14.98	0.65
2800	29.07	39.90	10.23	10.38	1.59	0.90	27.77	14.79	0.64
2900	28.86	39.09	10.41	10.41	1.50	0.89	28.04	15.00	0.65
3000	28.68	39.60	10.65	10.47	1.62	0.90	27.72	14.82	0.71
3100	28.52	39.17	10.80	10.43	1.58	0.89	27.41	14.57	0.64
3200	28.37	39.19	10.95	10.51	1.61	0.90	27.13	14.12	0.69
3300	28.24	38.70	10.98	10.50	1.56	0.89	27.28	14.28	0.65
3400	28.14	39.21	10.98	10.54	1.65	0.90	26.89	14.27	0.68
3500	28.01	39.04	10.92	10.62	1.65	0.90	26.42	14.12	0.69
3600	27.89	38.83	10.90	10.66	1.63	0.90	26.42	13.75	0.73
3700	27.76	38.34	10.87	10.81	1.59	0.90	26.11	13.60	0.70
3800	27.66	39.69	10.75	10.88	1.82	0.93	25.68	13.19	0.71
3900	27.56	39.09	10.71	11.08	1.74	0.92	25.62	12.97	0.68
4000	27.47	38.47	10.63	11.28	1.66	0.92	25.60	13.25	0.73
4100	27.38	39.42	10.59	11.48	1.84	0.94	25.04	12.88	0.73
4200	27.30	38.73	10.45	11.68	1.73	0.93	24.80	12.64	0.75
4300	27.23	39.19	10.30	11.99	1.83	0.95	24.91	12.64	0.76
4400	27.13	38.61	10.27	12.38	1.75	0.95	24.32	12.30	0.78
4500	27.06	39.32	10.12	12.78	1.90	0.97	23.97	12.00	0.81
4600	26.96	38.69	10.11	13.26	1.81	0.97	23.95	12.04	0.82
4700	26.87	39.07	10.08	13.78	1.90	0.98	23.35	11.51	0.83
4800	26.77	38.87	10.09	14.39	1.90	0.99	23.77	11.58	0.83
4900	26.68	38.81	10.01	15.19	1.91	0.99	23.62	11.53	0.84
5000	26.54	38.49	9.99	16.13	1.89	1.00	23.36	11.52	0.88
5100	26.43	38.54	10.04	17.13	1.93	1.01	22.68	11.05	0.92
5200	26.29	38.60	10.09	18.57	1.98	1.01	23.28	11.53	0.94
5300	26.13	38.46	10.21	20.04	1.99	1.02	22.98	11.30	0.94
5400	25.96	39.01	10.37	21.54	2.16	1.03	22.39	10.99	0.97
5500	25.78	39.05	10.55	23.14	2.22	1.03	21.78	10.34	1.00
5600	25.62	38.94	10.70	25.36	2.24	1.03	22.53	10.89	1.04
5700	25.42	38.40	10.96	27.43	2.17	1.02	22.31	10.62	1.05
5800	25.21	38.89	11.29	26.02	2.34	1.03	22.20	10.63	1.11
5900	24.99	38.67	11.60	23.91	2.35	1.02	22.50	10.92	1.10
6000	24.75	39.74	12.01	21.44	2.71	1.02	22.08	10.67	1.16

## Typical Performance Data

### Definitions:

Input Return Loss = -S11 (dB)  
 Gain(Power Gain) = S21 (dB)  
 Reverse Isolation = -S12 (dB)  
 Output Return Loss = -S22 (dB)

TEST CONDITIONS: Vd = 4.75V, Id = 65mA @ Temperature = +25°C

FREQ	Gain	Isolation	Input Return Loss	Output Return Loss	Stability		IP-3 Output	1dB Comp. Output	Noise Figure
					K	Measure			
(MHz)	(dB)	(dB)	(dB)	(dB)	K	Measure	(dBm)	(dBm)	(dB)
1000	28.74	50.70	3.90	17.77	3.66	1.38	24.22	12.91	1.89
1100	29.97	50.83	3.85	17.93	3.25	1.38	25.04	13.57	1.58
1200	30.87	48.66	3.90	15.68	2.29	1.36	26.18	14.05	1.40
1300	31.44	48.74	4.09	13.70	2.22	1.31	26.35	14.20	1.24
1400	31.75	46.32	4.40	12.28	1.74	1.23	27.05	14.41	1.13
1500	31.86	46.05	4.83	11.37	1.71	1.19	27.58	14.79	1.00
1600	31.84	44.25	5.27	10.78	1.48	1.12	27.92	14.86	0.90
1700	31.67	43.61	5.82	10.43	1.45	1.08	27.87	14.82	0.84
1800	31.48	42.19	6.35	10.26	1.33	1.03	28.03	14.71	0.80
1900	31.23	41.45	6.82	10.19	1.35	0.98	28.40	14.86	0.72
2000	30.98	41.19	7.35	10.16	1.35	0.97	28.34	14.93	0.68
2100	30.70	40.73	7.76	10.16	1.36	0.95	28.70	14.60	0.68
2200	30.42	41.15	8.28	10.27	1.49	0.95	28.30	14.69	0.62
2300	30.16	39.75	8.58	10.26	1.35	0.92	28.46	14.92	0.63
2400	29.90	40.26	9.01	10.37	1.45	0.93	28.11	14.72	0.59
2500	29.63	39.64	9.39	10.41	1.45	0.91	27.65	14.36	0.61
2600	29.40	40.60	9.61	10.49	1.62	0.93	27.28	14.30	0.64
2700	29.14	40.11	9.92	10.53	1.60	0.92	27.63	14.51	0.65
2800	28.93	39.52	10.13	10.50	1.55	0.91	26.60	14.21	0.66
2900	28.72	39.05	10.34	10.55	1.53	0.89	27.40	14.42	0.66
3000	28.55	39.44	10.54	10.65	1.62	0.90	27.16	14.35	0.71
3100	28.39	39.00	10.71	10.62	1.58	0.90	26.71	13.98	0.65
3200	28.23	39.31	10.87	10.66	1.65	0.91	26.44	13.65	0.71
3300	28.10	39.28	10.90	10.66	1.67	0.91	26.66	13.81	0.65
3400	27.99	38.84	10.90	10.71	1.62	0.90	26.11	13.79	0.70
3500	27.87	38.81	10.93	10.82	1.65	0.90	25.79	13.52	0.71
3600	27.74	39.14	10.83	10.83	1.71	0.91	25.71	13.15	0.73
3700	27.61	39.29	10.82	10.98	1.77	0.92	25.43	13.00	0.70
3800	27.51	38.78	10.72	11.13	1.70	0.92	24.96	12.82	0.71
3900	27.40	38.95	10.68	11.32	1.75	0.92	24.71	12.48	0.70
4000	27.32	39.49	10.62	11.48	1.86	0.94	24.81	12.75	0.72
4100	27.22	38.48	10.57	11.71	1.71	0.93	24.44	12.39	0.75
4200	27.14	38.71	10.44	11.91	1.76	0.94	24.18	12.14	0.76
4300	27.06	39.16	10.31	12.21	1.86	0.96	24.22	12.03	0.77
4400	26.95	38.55	10.30	12.58	1.79	0.95	23.72	11.69	0.80
4500	26.88	38.93	10.18	12.98	1.87	0.96	23.27	11.50	0.79
4600	26.78	38.76	10.14	13.51	1.87	0.97	23.35	11.53	0.81
4700	26.69	39.02	10.14	14.02	1.94	0.98	22.78	11.11	0.83
4800	26.58	38.37	10.10	14.67	1.85	0.98	23.20	11.08	0.83
4900	26.48	38.66	10.08	15.47	1.93	0.99	23.04	11.02	0.87
5000	26.34	39.25	10.09	16.30	2.09	1.01	22.80	11.01	0.89
5100	26.22	38.77	10.16	17.41	2.02	1.01	22.13	10.42	0.91
5200	26.07	38.79	10.22	18.66	2.07	1.02	22.72	11.00	0.98
5300	25.91	38.84	10.34	20.09	2.13	1.02	22.45	10.88	0.98
5400	25.74	39.05	10.52	21.46	2.22	1.03	21.88	10.47	0.98
5500	25.56	38.33	10.74	22.82	2.12	1.02	21.39	9.81	1.01
5600	25.39	38.99	10.91	24.15	2.31	1.03	22.08	10.48	1.02
5700	25.19	38.67	11.10	25.43	2.29	1.02	21.80	10.31	1.06
5800	24.98	39.03	11.44	24.24	2.44	1.02	21.68	10.10	1.12
5900	24.76	39.06	11.83	22.45	2.51	1.02	22.00	10.61	1.12
6000	24.52	39.01	12.24	20.62	2.57	1.01	21.69	10.24	1.17

## Typical Performance Data

### Definitions:

Input Return Loss = -S11 (dB)

Gain(Power Gain) = S21 (dB)

Reverse Isolation = -S12 (dB)

Output Return Loss = -S22 (dB)

TEST CONDITIONS: Vd = 5.25V, Id = 70mA @ Temperature = +25°C

FREQ	Gain	Isolation	Input Return Loss	Output Return Loss	Stability		IP-3 Output	1dB Comp. Output	Noise Figure
					K	Measure			
(MHz)	(dB)	(dB)	(dB)	(dB)	K	Measure	(dBm)	(dBm)	(dB)
1000	29.14	51.73	3.97	17.70	4.00	1.37	25.35	13.77	1.86
1100	30.35	50.27	3.96	17.95	2.97	1.37	26.11	14.43	1.57
1200	31.22	49.83	4.05	15.71	2.59	1.34	27.22	14.89	1.38
1300	31.77	48.89	4.24	13.74	2.25	1.29	27.42	15.03	1.21
1400	32.05	45.72	4.60	12.29	1.60	1.22	28.01	15.34	1.11
1500	32.14	45.44	5.04	11.36	1.60	1.16	28.52	15.71	1.00
1600	32.11	42.90	5.51	10.82	1.31	1.08	28.91	15.78	0.89
1700	31.93	43.98	6.05	10.42	1.50	1.07	28.82	15.73	0.82
1800	31.73	42.29	6.56	10.17	1.36	1.00	29.13	15.72	0.78
1900	31.47	41.88	7.08	10.08	1.36	0.98	29.46	15.77	0.72
2000	31.22	41.92	7.59	10.03	1.44	0.96	29.52	15.83	0.66
2100	30.94	41.32	8.01	10.02	1.42	0.94	29.82	15.50	0.69
2200	30.66	41.24	8.51	10.11	1.46	0.94	29.47	15.59	0.61
2300	30.39	41.15	8.89	10.10	1.52	0.93	30.01	15.94	0.62
2400	30.13	40.60	9.23	10.17	1.48	0.92	29.57	15.74	0.61
2500	29.87	39.70	9.62	10.23	1.42	0.89	28.94	15.26	0.57
2600	29.64	39.40	9.90	10.24	1.43	0.88	28.64	15.31	0.62
2700	29.38	39.80	10.13	10.27	1.52	0.90	28.07	15.54	0.64
2800	29.18	39.72	10.34	10.28	1.54	0.90	28.75	15.23	0.63
2900	28.97	39.30	10.48	10.30	1.52	0.89	28.57	15.45	0.64
3000	28.80	39.83	10.72	10.38	1.63	0.90	28.28	15.27	0.69
3100	28.64	39.42	10.85	10.33	1.59	0.89	28.07	15.01	0.63
3200	28.48	39.47	11.04	10.37	1.63	0.90	27.92	14.69	0.69
3300	28.36	38.86	11.07	10.38	1.57	0.88	27.94	14.85	0.64
3400	28.26	39.87	11.05	10.42	1.74	0.90	27.62	14.96	0.66
3500	28.13	39.88	11.01	10.48	1.76	0.91	27.01	14.46	0.68
3600	28.01	39.08	10.93	10.52	1.65	0.90	26.96	14.20	0.72
3700	27.89	38.86	10.88	10.65	1.64	0.90	26.75	14.06	0.71
3800	27.79	38.73	10.81	10.82	1.64	0.90	26.38	13.65	0.70
3900	27.69	39.03	10.74	10.94	1.70	0.92	26.08	13.55	0.68
4000	27.61	38.69	10.65	11.10	1.67	0.91	26.24	13.83	0.70
4100	27.52	38.96	10.60	11.32	1.74	0.92	25.71	13.35	0.72
4200	27.45	38.96	10.47	11.53	1.74	0.93	25.47	13.11	0.73
4300	27.38	39.78	10.31	11.84	1.90	0.96	25.62	13.01	0.75
4400	27.28	38.85	10.25	12.18	1.76	0.95	25.07	12.78	0.79
4500	27.21	38.37	10.16	12.57	1.70	0.95	24.60	12.48	0.81
4600	27.11	39.03	10.11	13.12	1.84	0.97	24.65	12.52	0.80
4700	27.03	38.73	10.06	13.62	1.81	0.97	24.13	12.12	0.81
4800	26.93	38.78	10.02	14.22	1.84	0.98	24.39	12.06	0.81
4900	26.84	38.32	9.96	15.04	1.79	0.98	24.31	12.02	0.85
5000	26.72	38.48	9.92	15.97	1.84	1.00	24.07	12.02	0.87
5100	26.61	39.04	9.98	16.95	1.98	1.01	23.38	11.44	0.91
5200	26.47	38.42	10.00	18.38	1.90	1.01	23.95	11.92	0.93
5300	26.31	38.17	10.14	19.97	1.90	1.01	23.67	11.80	0.95
5400	26.14	38.13	10.28	21.62	1.93	1.01	23.04	11.38	0.95
5500	25.97	39.01	10.45	23.49	2.16	1.03	22.44	10.71	0.97
5600	25.81	39.03	10.61	26.19	2.21	1.03	23.25	11.38	1.00
5700	25.62	38.53	10.83	29.09	2.15	1.03	22.98	11.24	1.04
5800	25.41	38.97	11.11	27.87	2.31	1.03	22.83	11.02	1.08
5900	25.19	38.86	11.50	24.91	2.34	1.02	23.10	11.42	1.09
6000	24.95	39.16	11.86	22.09	2.48	1.02	22.73	11.05	1.15



## Typical Performance Data

## Definitions:

Input Return Loss = -S11 (dB)

Gain(Power Gain) = S21 (dB)

Reverse Isolation = -S12 (dB)

Output Return Loss = -S22 (dB)

TEST CONDITIONS: Vd = 5.00V, Id = 69mA @ Temperature = -45°C

FREQ	Gain	Isolation	Input Return Loss	Output Return Loss	Stability		IP-3 Output	1dB Comp. Output	Noise Figure
					K	Measure			
(MHz)	(dB)	(dB)	(dB)	(dB)	K	Measure	(dBm)	(dBm)	(dB)
1000	30.37	52.75	3.44	18.26	3.55	1.43	26.20	13.85	1.23
1100	31.54	51.62	3.55	18.88	2.80	1.42	26.80	14.48	1.03
1200	32.36	51.44	3.76	16.28	2.63	1.37	27.71	14.88	0.90
1300	32.83	48.49	4.13	13.94	1.91	1.29	27.89	14.96	0.78
1400	33.04	47.54	4.60	12.36	1.75	1.22	28.42	15.19	0.70
1500	33.06	43.94	5.15	11.44	1.29	1.12	28.90	15.51	0.61
1600	32.96	45.08	5.74	10.75	1.51	1.08	29.25	15.63	0.51
1700	32.72	43.14	6.35	10.36	1.34	1.01	29.32	15.50	0.47
1800	32.47	43.19	6.89	10.12	1.41	0.98	29.35	15.33	0.47
1900	32.17	42.25	7.47	9.98	1.34	0.96	29.69	15.46	0.39
2000	31.89	41.86	8.01	9.90	1.36	0.93	29.72	15.48	0.35
2100	31.58	42.36	8.43	9.82	1.48	0.94	29.91	15.13	0.36
2200	31.28	41.12	8.97	9.84	1.38	0.90	29.83	15.18	0.29
2300	31.00	41.05	9.31	9.77	1.43	0.89	30.20	15.39	0.32
2400	30.73	41.23	9.64	9.81	1.49	0.90	29.96	15.20	0.28
2500	30.45	40.34	10.03	9.81	1.42	0.88	29.39	14.68	0.29
2600	30.21	40.07	10.20	9.79	1.43	0.87	29.17	14.74	0.33
2700	29.95	40.35	10.47	9.78	1.50	0.88	28.46	14.96	0.34
2800	29.74	39.89	10.68	9.72	1.47	0.87	28.67	14.63	0.34
2900	29.53	40.07	10.91	9.75	1.53	0.88	28.40	14.72	0.33
3000	29.35	39.85	11.05	9.78	1.54	0.87	28.24	14.65	0.38
3100	29.19	39.86	11.24	9.66	1.56	0.87	27.99	14.28	0.34
3200	29.04	39.31	11.38	9.66	1.52	0.85	27.85	13.94	0.39
3300	28.93	39.46	11.47	9.62	1.55	0.86	27.97	14.12	0.35
3400	28.84	39.69	11.49	9.62	1.59	0.87	27.52	14.11	0.38
3500	28.72	39.20	11.40	9.65	1.53	0.87	27.03	13.85	0.38
3600	28.60	39.09	11.33	9.69	1.53	0.87	26.93	13.60	0.40
3700	28.48	39.51	11.25	9.71	1.62	0.88	26.76	13.34	0.37
3800	28.37	39.00	11.13	9.79	1.56	0.87	26.25	12.93	0.37
3900	28.27	38.86	11.07	9.90	1.56	0.87	26.01	12.72	0.36
4000	28.20	39.62	10.92	10.00	1.69	0.90	26.23	13.11	0.38
4100	28.12	38.79	10.76	10.11	1.57	0.89	25.69	12.64	0.39
4200	28.05	40.03	10.62	10.23	1.79	0.91	25.41	12.37	0.40
4300	27.98	39.42	10.36	10.40	1.68	0.92	25.55	12.28	0.42
4400	27.89	39.26	10.29	10.68	1.68	0.92	25.02	12.08	0.45
4500	27.83	38.62	10.13	10.91	1.60	0.91	24.68	11.78	0.44
4600	27.75	38.67	9.95	11.23	1.62	0.93	24.64	11.85	0.44
4700	27.68	37.99	9.88	11.61	1.54	0.92	24.06	11.46	0.45
4800	27.60	38.72	9.79	11.99	1.67	0.95	24.42	11.39	0.45
4900	27.53	38.38	9.67	12.59	1.64	0.95	24.22	11.38	0.46
5000	27.42	38.74	9.59	13.19	1.72	0.97	23.99	11.30	0.49
5100	27.34	38.74	9.58	13.97	1.74	0.98	23.27	10.85	0.51
5200	27.23	38.11	9.48	14.96	1.66	0.99	23.93	11.35	0.55
5300	27.09	38.35	9.56	15.95	1.74	1.00	23.54	11.24	0.54
5400	26.95	38.43	9.65	17.14	1.79	1.00	22.91	10.74	0.54
5500	26.81	38.32	9.77	18.43	1.81	1.01	22.37	10.07	0.57
5600	26.67	38.08	9.92	20.20	1.80	1.01	23.16	10.75	0.57
5700	26.52	38.01	10.06	23.07	1.83	1.02	22.83	10.64	0.60
5800	26.34	38.57	10.26	27.75	1.98	1.03	22.71	10.44	0.64
5900	26.14	38.31	10.51	32.26	1.98	1.02	23.05	10.88	0.62
6000	25.92	38.32	10.82	31.79	2.03	1.02	22.64	10.65	0.66

## Typical Performance Data

### Definitions:

Input Return Loss = -S11 (dB)

Gain(Power Gain) = S21 (dB)

Reverse Isolation = -S12 (dB)

Output Return Loss = -S22 (dB)

TEST CONDITIONS: Vd = 4.75V, Id = 66mA @ Temperature = -45°C

FREQ	Gain	Isolation	Input Return Loss	Output Return Loss	Stability		IP-3 Output	1dB Comp. Output	Noise Figure
					K	Measure			
(MHz)	(dB)	(dB)	(dB)	(dB)			(dBm)	(dBm)	(dB)
1000	30.19	52.42	3.40	18.26	3.46	1.44	24.22	13.37	1.24
1100	31.38	51.51	3.49	18.79	2.81	1.42	25.04	14.11	1.03
1200	32.21	48.89	3.69	16.12	1.98	1.37	26.18	14.41	0.90
1300	32.70	49.58	4.02	13.94	2.11	1.31	26.35	14.50	0.78
1400	32.92	45.91	4.50	12.39	1.49	1.22	27.05	14.73	0.69
1500	32.94	45.26	5.07	11.41	1.47	1.14	27.58	15.04	0.61
1600	32.85	46.20	5.59	10.72	1.65	1.12	27.92	15.17	0.52
1700	32.61	43.05	6.22	10.39	1.30	1.03	27.87	14.94	0.48
1800	32.37	43.03	6.79	10.15	1.38	1.00	28.03	14.88	0.44
1900	32.07	42.48	7.37	10.02	1.39	0.96	28.40	14.89	0.39
2000	31.79	40.75	7.92	9.95	1.24	0.91	28.34	14.91	0.35
2100	31.49	40.34	8.33	9.88	1.26	0.88	28.70	14.56	0.35
2200	31.18	40.94	8.79	9.90	1.37	0.91	28.30	14.61	0.30
2300	30.90	40.51	9.15	9.86	1.37	0.89	28.46	14.82	0.31
2400	30.63	40.58	9.53	9.86	1.42	0.89	28.11	14.61	0.28
2500	30.35	40.38	9.85	9.86	1.45	0.88	27.65	14.10	0.32
2600	30.12	39.94	10.12	9.89	1.42	0.88	27.28	14.15	0.32
2700	29.86	40.21	10.38	9.84	1.50	0.88	27.63	14.26	0.32
2800	29.65	39.62	10.59	9.82	1.45	0.87	26.60	13.91	0.32
2900	29.43	39.97	10.77	9.84	1.54	0.88	27.40	13.99	0.34
3000	29.25	39.89	10.97	9.88	1.55	0.88	27.16	14.05	0.38
3100	29.09	39.82	11.14	9.75	1.57	0.87	26.71	13.67	0.33
3200	28.93	39.65	11.30	9.76	1.58	0.87	26.44	13.20	0.38
3300	28.82	39.39	11.40	9.71	1.55	0.87	26.66	13.38	0.34
3400	28.73	39.03	11.43	9.73	1.52	0.86	26.11	13.49	0.37
3500	28.61	39.45	11.37	9.76	1.60	0.87	25.79	13.10	0.38
3600	28.49	39.74	11.23	9.76	1.66	0.88	25.71	12.85	0.40
3700	28.36	38.90	11.22	9.85	1.55	0.87	25.43	12.59	0.37
3800	28.26	39.77	11.08	9.88	1.70	0.89	24.96	12.30	0.39
3900	28.16	39.00	10.99	10.01	1.60	0.88	24.71	12.08	0.35
4000	28.08	38.60	10.84	10.14	1.55	0.88	24.81	12.35	0.38
4100	28.00	38.82	10.72	10.24	1.60	0.89	24.44	12.00	0.39
4200	27.92	39.23	10.57	10.34	1.67	0.90	24.18	11.74	0.40
4300	27.86	38.30	10.36	10.53	1.54	0.90	24.22	11.52	0.41
4400	27.76	38.99	10.27	10.78	1.66	0.92	23.72	11.44	0.44
4500	27.70	38.92	10.10	11.02	1.67	0.92	23.27	11.14	0.44
4600	27.62	38.70	10.00	11.41	1.66	0.93	23.35	11.21	0.44
4700	27.55	39.02	9.88	11.75	1.72	0.95	22.78	10.81	0.44
4800	27.46	38.74	9.77	12.13	1.70	0.95	23.20	10.77	0.45
4900	27.38	39.13	9.70	12.70	1.79	0.97	23.04	10.75	0.46
5000	27.28	38.24	9.63	13.37	1.67	0.96	22.80	10.77	0.47
5100	27.19	38.82	9.60	14.07	1.78	0.99	22.13	10.32	0.52
5200	27.08	38.44	9.58	15.07	1.75	0.99	22.72	10.70	0.54
5300	26.94	38.77	9.64	16.14	1.85	1.00	22.45	10.58	0.54
5400	26.80	38.25	9.74	17.26	1.79	1.00	21.88	10.20	0.53
5500	26.64	38.61	9.84	18.51	1.90	1.01	21.39	9.54	0.55
5600	26.50	38.38	9.99	20.16	1.89	1.02	22.08	10.10	0.57
5700	26.35	38.14	10.15	23.10	1.89	1.02	21.80	9.99	0.58
5800	26.16	38.47	10.36	27.05	2.00	1.03	21.68	9.89	0.62
5900	25.97	38.65	10.63	29.97	2.09	1.03	22.00	10.34	0.64
6000	25.74	38.92	10.94	29.36	2.21	1.03	21.69	10.10	0.66

## Typical Performance Data

## Definitions:

Input Return Loss = -S11 (dB)

Gain(Power Gain) = S21 (dB)

Reverse Isolation = -S12 (dB)

Output Return Loss = -S22 (dB)

TEST CONDITIONS: Vd = 5.25V, Id = 72mA @ Temperature = -45°C

FREQ	Gain	Isolation	Input Return Loss	Output Return Loss	Stability		IP-3 Output	1dB Comp. Output	Noise Figure
					K	Measure			
(MHz)	(dB)	(dB)	(dB)	(dB)	K	Measure	(dBm)	(dBm)	(dB)
1000	30.52	51.89	3.51	18.24	3.20	1.42	26.55	14.20	1.24
1100	31.68	53.55	3.61	18.94	3.49	1.41	27.20	14.94	1.00
1200	32.49	51.43	3.83	16.34	2.60	1.36	28.06	15.22	0.90
1300	32.95	48.58	4.21	14.02	1.93	1.28	28.31	15.40	0.78
1400	33.15	45.60	4.70	12.41	1.46	1.19	28.93	15.63	0.68
1500	33.16	44.42	5.28	11.46	1.37	1.11	29.43	16.05	0.60
1600	33.05	43.82	5.85	10.82	1.35	1.05	29.80	16.06	0.51
1700	32.80	45.19	6.47	10.32	1.61	1.04	29.73	15.94	0.46
1800	32.56	43.49	7.07	10.15	1.42	1.00	29.86	15.77	0.44
1900	32.26	42.83	7.61	9.98	1.43	0.95	30.13	15.90	0.40
2000	31.97	41.61	8.15	9.86	1.32	0.92	30.24	15.80	0.35
2100	31.66	41.75	8.58	9.79	1.38	0.92	30.33	15.56	0.36
2200	31.36	41.98	9.05	9.86	1.48	0.92	30.54	15.61	0.30
2300	31.08	40.47	9.38	9.72	1.34	0.87	30.61	15.83	0.32
2400	30.81	40.69	9.75	9.76	1.42	0.88	30.61	15.64	0.28
2500	30.53	40.90	10.15	9.75	1.48	0.89	29.97	15.23	0.29
2600	30.29	40.97	10.33	9.76	1.54	0.89	29.74	15.18	0.32
2700	30.03	40.21	10.63	9.76	1.48	0.87	29.73	15.41	0.34
2800	29.83	40.38	10.77	9.69	1.53	0.88	28.85	15.20	0.33
2900	29.62	39.58	10.96	9.66	1.45	0.86	29.26	15.17	0.35
3000	29.44	39.27	11.13	9.68	1.44	0.86	29.05	15.23	0.38
3100	29.28	40.24	11.33	9.63	1.59	0.88	28.60	14.86	0.33
3200	29.12	40.05	11.53	9.60	1.60	0.87	28.46	14.53	0.39
3300	29.01	39.35	11.56	9.54	1.52	0.85	28.66	14.82	0.35
3400	28.92	38.93	11.55	9.54	1.47	0.85	28.29	14.70	0.37
3500	28.81	39.13	11.48	9.58	1.52	0.86	27.90	14.44	0.39
3600	28.69	39.66	11.38	9.58	1.61	0.87	27.49	14.07	0.41
3700	28.56	39.72	11.35	9.65	1.64	0.88	27.48	13.94	0.36
3800	28.47	38.93	11.22	9.73	1.53	0.87	26.96	13.64	0.36
3900	28.37	39.04	11.09	9.82	1.57	0.87	26.71	13.44	0.36
4000	28.29	39.57	10.94	9.95	1.66	0.89	26.89	13.71	0.38
4100	28.21	38.87	10.81	10.06	1.56	0.89	26.41	13.24	0.37
4200	28.14	39.34	10.64	10.17	1.65	0.90	26.21	12.98	0.39
4300	28.08	38.80	10.40	10.30	1.57	0.90	26.24	12.89	0.40
4400	27.99	39.00	10.29	10.60	1.62	0.91	25.73	12.68	0.43
4500	27.94	38.76	10.13	10.81	1.60	0.91	25.40	12.40	0.45
4600	27.86	38.72	10.00	11.16	1.61	0.93	25.30	12.45	0.44
4700	27.79	38.90	9.88	11.52	1.65	0.94	24.77	12.07	0.44
4800	27.71	38.87	9.77	11.93	1.67	0.95	25.02	11.90	0.43
4900	27.64	38.78	9.68	12.49	1.67	0.96	24.85	11.88	0.44
5000	27.54	39.45	9.56	13.06	1.81	0.98	24.66	11.90	0.47
5100	27.46	38.13	9.53	13.89	1.63	0.97	24.01	11.47	0.50
5200	27.35	38.49	9.49	14.88	1.70	0.99	24.59	11.96	0.52
5300	27.21	38.35	9.51	15.89	1.71	1.00	24.24	11.75	0.53
5400	27.08	38.58	9.63	17.07	1.79	1.01	23.58	11.36	0.53
5500	26.93	38.65	9.72	18.38	1.84	1.01	23.04	10.69	0.55
5600	26.79	38.56	9.86	20.06	1.86	1.02	23.85	11.37	0.54
5700	26.65	38.78	9.98	23.04	1.94	1.03	23.46	11.15	0.58
5800	26.47	38.23	10.17	27.74	1.88	1.02	23.45	11.05	0.62
5900	26.27	38.48	10.45	33.87	1.98	1.03	23.79	11.49	0.61
6000	26.05	38.80	10.74	34.73	2.10	1.03	23.30	11.14	0.65

## Typical Performance Data

### Definitions:

Input Return Loss = -S11 (dB)

Gain(Power Gain) = S21 (dB)

Reverse Isolation = -S12 (dB)

Output Return Loss = -S22 (dB)

TEST CONDITIONS: Vd = 5.00V, Id = 66mA @ Temperature = +85°C

FREQ	Gain	Isolation	Input Return Loss	Output Return Loss	Stability		IP-3 Output	1dB Comp. Output	Noise Figure
					K	Measure			
(MHz)	(dB)	(dB)	(dB)	(dB)	K	Measure	(dBm)	(dBm)	(dB)
1000	27.91	50.09	4.34	17.42	4.02	1.34	24.05	13.26	2.42
1100	29.14	49.13	4.22	17.61	3.10	1.34	24.71	13.93	2.06
1200	30.06	48.54	4.19	15.58	2.60	1.32	25.83	14.33	1.83
1300	30.67	47.10	4.30	13.66	2.09	1.28	26.45	14.53	1.63
1400	31.03	46.86	4.51	12.36	1.97	1.25	27.14	14.90	1.49
1500	31.19	45.31	4.85	11.46	1.69	1.19	27.54	15.20	1.35
1600	31.22	43.98	5.21	10.92	1.51	1.14	27.85	15.32	1.24
1700	31.09	43.47	5.71	10.57	1.52	1.10	27.76	15.21	1.15
1800	30.94	42.35	6.20	10.40	1.42	1.05	27.97	15.25	1.09
1900	30.72	42.18	6.67	10.34	1.48	1.03	28.19	15.42	1.03
2000	30.50	41.45	7.16	10.37	1.44	1.00	28.14	15.40	0.97
2100	30.24	40.52	7.59	10.40	1.39	0.97	28.39	15.21	0.97
2200	29.98	40.01	8.07	10.56	1.38	0.95	27.99	15.20	0.89
2300	29.73	41.15	8.47	10.61	1.61	0.96	28.19	15.46	0.91
2400	29.48	40.62	8.81	10.69	1.59	0.95	27.71	15.38	0.86
2500	29.22	39.54	9.18	10.80	1.49	0.93	27.58	15.02	0.87
2600	28.99	39.35	9.49	10.95	1.50	0.93	27.30	14.96	0.90
2700	28.74	39.15	9.78	11.01	1.53	0.92	26.73	15.05	0.92
2800	28.54	39.54	9.99	11.08	1.63	0.92	27.27	14.88	0.93
2900	28.33	38.78	10.18	11.11	1.55	0.91	27.37	14.98	0.92
3000	28.16	38.97	10.40	11.24	1.62	0.92	27.12	14.91	0.97
3100	28.00	38.83	10.61	11.29	1.62	0.92	26.78	14.66	0.91
3200	27.84	38.87	10.73	11.38	1.67	0.92	26.55	14.21	0.96
3300	27.71	39.46	10.81	11.42	1.79	0.93	26.69	14.47	0.94
3400	27.59	39.29	10.83	11.52	1.78	0.93	26.10	14.45	0.97
3500	27.46	38.45	10.80	11.61	1.67	0.92	25.80	14.18	1.01
3600	27.33	38.53	10.75	11.71	1.71	0.93	25.73	13.80	1.01
3700	27.19	38.67	10.75	11.89	1.76	0.93	25.42	13.65	1.00
3800	27.09	39.07	10.65	12.05	1.84	0.95	25.00	13.34	1.00
3900	26.97	38.72	10.60	12.28	1.81	0.95	24.93	13.11	0.99
4000	26.88	39.14	10.58	12.54	1.90	0.96	24.88	13.26	1.02
4100	26.78	39.03	10.51	12.82	1.91	0.96	24.48	12.89	1.05
4200	26.69	38.47	10.43	13.16	1.83	0.96	24.22	12.65	1.06
4300	26.60	38.23	10.31	13.54	1.80	0.97	24.17	12.51	1.08
4400	26.48	38.79	10.31	13.97	1.94	0.98	23.78	12.26	1.13
4500	26.40	39.34	10.21	14.54	2.08	0.99	23.32	11.95	1.14
4600	26.28	38.59	10.22	15.15	1.96	0.99	23.42	11.97	1.15
4700	26.18	38.80	10.24	15.80	2.03	1.00	22.85	11.54	1.17
4800	26.05	38.16	10.22	16.57	1.93	1.00	23.25	11.62	1.19
4900	25.94	38.55	10.22	17.52	2.04	1.01	23.05	11.55	1.20
5000	25.79	38.53	10.27	18.60	2.08	1.01	22.77	11.40	1.24
5100	25.65	38.66	10.34	19.83	2.14	1.02	22.17	10.90	1.29
5200	25.48	38.53	10.45	21.33	2.16	1.02	22.73	11.47	1.34
5300	25.30	38.76	10.60	22.62	2.26	1.03	22.47	11.21	1.37
5400	25.11	38.81	10.81	23.50	2.33	1.03	21.93	10.77	1.36
5500	24.92	39.64	10.99	23.69	2.60	1.03	21.42	10.23	1.41
5600	24.73	39.03	11.24	23.88	2.50	1.03	22.08	10.77	1.43
5700	24.51	38.84	11.53	22.74	2.51	1.02	21.78	10.59	1.46
5800	24.29	39.62	11.88	20.80	2.80	1.02	21.70	10.36	1.54
5900	24.05	39.17	12.35	19.31	2.75	1.01	22.06	10.73	1.55
6000	23.80	39.17	12.79	17.80	2.82	1.01	21.63	10.46	1.60

## Typical Performance Data

### Definitions:

Input Return Loss = -S11 (dB)

Gain(Power Gain) = S21 (dB)

Reverse Isolation = -S12 (dB)

Output Return Loss = -S22 (dB)

TEST CONDITIONS: Vd = 4.75V, Id = 63mA @ Temperature = +85°C

FREQ	Gain	Isolation	Input Return Loss	Output Return Loss	Stability		IP-3 Output	1dB Comp. Output	Noise Figure
					K	Measure			
(MHz)	(dB)	(dB)	(dB)	(dB)	K	Measure	(dBm)	(dBm)	(dB)
1000	27.69	50.64	4.30	17.48	4.34	1.35	23.45	12.70	2.41
1100	28.94	50.82	4.16	17.64	3.80	1.35	24.15	13.51	2.07
1200	29.87	48.05	4.12	15.60	2.48	1.33	25.39	13.90	1.81
1300	30.49	47.41	4.21	13.69	2.17	1.30	25.90	14.11	1.63
1400	30.86	45.42	4.43	12.37	1.74	1.23	26.44	14.36	1.47
1500	31.03	43.46	4.76	11.49	1.44	1.17	26.92	14.67	1.35
1600	31.07	43.26	5.12	10.96	1.42	1.14	27.36	14.90	1.21
1700	30.95	42.99	5.61	10.63	1.46	1.10	27.19	14.79	1.13
1800	30.80	42.29	6.09	10.47	1.43	1.06	27.46	14.71	1.10
1900	30.58	40.59	6.55	10.46	1.28	1.01	27.71	14.88	1.03
2000	30.36	41.30	7.02	10.47	1.44	1.00	27.52	14.86	0.96
2100	30.11	41.67	7.45	10.48	1.54	1.01	27.63	14.68	0.97
2200	29.84	40.54	7.92	10.67	1.47	0.97	27.33	14.78	0.89
2300	29.59	40.12	8.32	10.69	1.48	0.95	27.72	14.92	0.91
2400	29.34	39.76	8.69	10.81	1.49	0.94	27.37	14.83	0.88
2500	29.08	39.58	9.12	10.94	1.52	0.93	26.78	14.48	0.88
2600	28.85	39.02	9.38	11.05	1.48	0.92	26.72	14.42	0.91
2700	28.60	39.47	9.67	11.13	1.59	0.94	26.88	14.63	0.91
2800	28.40	39.57	9.92	11.23	1.65	0.94	26.32	14.34	0.92
2900	28.19	38.87	10.12	11.33	1.60	0.92	26.62	14.55	0.93
3000	28.01	39.82	10.36	11.48	1.78	0.94	26.50	14.36	0.97
3100	27.85	39.53	10.50	11.47	1.77	0.93	26.21	14.10	0.93
3200	27.68	38.88	10.69	11.59	1.70	0.93	25.81	13.90	0.98
3300	27.55	39.39	10.74	11.63	1.81	0.93	25.93	13.92	0.95
3400	27.43	39.14	10.77	11.70	1.79	0.94	25.52	14.02	0.97
3500	27.30	38.27	10.77	11.82	1.67	0.93	25.12	13.62	0.99
3600	27.16	38.78	10.71	11.93	1.79	0.93	24.98	13.24	1.02
3700	27.03	38.80	10.72	12.14	1.82	0.94	24.81	13.08	1.00
3800	26.92	38.85	10.63	12.33	1.84	0.95	24.27	12.78	1.00
3900	26.80	38.56	10.63	12.56	1.82	0.95	24.18	12.55	0.99
4000	26.70	39.17	10.58	12.78	1.95	0.96	24.21	12.81	1.03
4100	26.60	37.96	10.50	13.07	1.76	0.95	23.78	12.32	1.06
4200	26.50	39.19	10.46	13.39	2.01	0.97	23.46	12.08	1.06
4300	26.41	39.13	10.39	13.76	2.02	0.98	23.57	11.93	1.09
4400	26.29	38.64	10.38	14.26	1.97	0.98	23.00	11.68	1.14
4500	26.19	39.35	10.27	14.75	2.13	1.00	22.58	11.36	1.14
4600	26.07	39.06	10.29	15.39	2.10	1.00	22.65	11.50	1.16
4700	25.96	38.62	10.29	16.04	2.04	1.00	22.10	11.07	1.17
4800	25.83	38.83	10.35	16.84	2.12	1.01	22.51	11.03	1.20
4900	25.71	38.88	10.32	17.76	2.17	1.02	22.33	11.07	1.21
5000	25.56	38.45	10.36	18.72	2.12	1.01	22.09	10.91	1.26
5100	25.41	38.68	10.48	19.86	2.21	1.02	21.44	10.41	1.32
5200	25.25	38.54	10.59	20.98	2.22	1.02	22.02	10.87	1.34
5300	25.06	38.86	10.73	22.08	2.35	1.03	21.77	10.61	1.36
5400	24.87	38.74	10.96	22.37	2.38	1.02	21.20	10.29	1.38
5500	24.67	38.73	11.21	22.37	2.44	1.02	20.70	9.63	1.41
5600	24.48	38.73	11.40	22.39	2.49	1.02	21.45	10.18	1.43
5700	24.26	39.14	11.71	21.48	2.67	1.02	21.15	10.00	1.48
5800	24.03	39.04	12.06	19.87	2.71	1.02	21.09	9.77	1.54
5900	23.80	39.78	12.53	18.57	3.02	1.01	21.34	10.26	1.55
6000	23.54	39.59	13.03	17.29	3.04	1.00	21.01	10.00	1.60

## Typical Performance Data

### Definitions:

Input Return Loss = -S11 (dB)

Gain(Power Gain) = S21 (dB)

Reverse Isolation = -S12 (dB)

Output Return Loss = -S22 (dB)

TEST CONDITIONS: Vd = 5.25V, Id = 69mA @ Temperature = +85°C

FREQ	Gain	Isolation	Input Return Loss	Output Return Loss	Stability		IP-3 Output	1dB Comp. Output	Noise Figure
					K	Measure			
(MHz)	(dB)	(dB)	(dB)	(dB)	K	Measure	(dBm)	(dBm)	(dB)
1000	28.09	50.61	4.38	17.38	4.20	1.34	24.64	13.64	2.40
1100	29.32	51.75	4.27	17.54	4.11	1.34	25.28	14.42	2.06
1200	30.23	50.29	4.25	15.56	3.10	1.33	26.26	14.80	1.81
1300	30.83	47.39	4.37	13.64	2.13	1.28	26.79	15.00	1.63
1400	31.18	46.90	4.61	12.34	1.98	1.24	27.38	15.35	1.47
1500	31.33	46.27	4.94	11.45	1.87	1.19	27.91	15.66	1.34
1600	31.35	43.72	5.32	10.87	1.48	1.12	28.21	15.88	1.23
1700	31.22	43.07	5.82	10.52	1.46	1.07	28.09	15.77	1.14
1800	31.07	43.27	6.30	10.37	1.55	1.06	28.33	15.68	1.08
1900	30.84	41.63	6.76	10.33	1.41	1.00	28.72	15.86	1.02
2000	30.61	41.50	7.25	10.28	1.44	0.99	28.66	15.96	0.96
2100	30.36	39.96	7.69	10.32	1.31	0.94	28.99	15.65	0.96
2200	30.09	40.35	8.15	10.46	1.43	0.94	28.40	15.64	0.89
2300	29.84	40.02	8.53	10.48	1.43	0.93	28.62	16.01	0.89
2400	29.59	40.04	8.91	10.58	1.49	0.93	28.36	15.81	0.85
2500	29.34	40.15	9.29	10.69	1.56	0.93	28.15	15.46	0.88
2600	29.11	40.16	9.60	10.78	1.60	0.94	27.79	15.40	0.91
2700	28.86	39.51	9.87	10.86	1.57	0.92	28.21	15.62	0.91
2800	28.66	40.21	10.07	10.93	1.71	0.93	27.32	15.33	0.91
2900	28.45	39.24	10.30	11.01	1.60	0.92	27.99	15.55	0.91
3000	28.28	39.12	10.48	11.09	1.62	0.92	27.79	15.37	0.96
3100	28.13	39.16	10.67	11.10	1.65	0.92	27.49	15.10	0.93
3200	27.96	39.80	10.82	11.18	1.80	0.93	27.07	14.78	0.97
3300	27.83	39.74	10.84	11.26	1.81	0.93	27.27	14.93	0.92
3400	27.72	39.11	10.87	11.31	1.73	0.92	26.91	14.91	0.96
3500	27.59	38.87	10.85	11.43	1.71	0.92	26.55	14.63	0.98
3600	27.47	39.56	10.81	11.54	1.86	0.94	26.42	14.38	1.01
3700	27.33	38.10	10.80	11.72	1.64	0.92	26.19	14.11	0.98
3800	27.23	39.27	10.66	11.90	1.86	0.94	25.76	13.81	1.00
3900	27.12	38.36	10.67	12.11	1.72	0.93	25.54	13.47	0.98
4000	27.03	39.07	10.57	12.34	1.86	0.95	25.65	13.74	1.01
4100	26.93	38.81	10.53	12.62	1.84	0.95	25.24	13.48	1.04
4200	26.84	38.27	10.39	12.94	1.76	0.95	24.91	13.25	1.05
4300	26.76	38.82	10.31	13.32	1.88	0.97	25.00	12.99	1.07
4400	26.65	38.99	10.27	13.74	1.94	0.98	24.48	12.75	1.12
4500	26.56	38.11	10.23	14.23	1.80	0.97	23.98	12.44	1.13
4600	26.45	39.01	10.16	14.90	1.99	1.00	24.09	12.47	1.13
4700	26.35	38.59	10.17	15.61	1.94	1.00	23.54	12.15	1.16
4800	26.23	38.95	10.21	16.41	2.05	1.01	23.88	12.12	1.18
4900	26.12	38.55	10.16	17.43	2.00	1.01	23.70	12.05	1.20
5000	25.97	38.31	10.15	18.51	1.99	1.01	23.45	11.91	1.24
5100	25.84	38.69	10.24	19.89	2.10	1.02	22.80	11.41	1.28
5200	25.68	38.36	10.31	21.46	2.07	1.02	23.45	11.87	1.32
5300	25.50	38.42	10.47	23.08	2.14	1.02	23.16	11.72	1.33
5400	25.32	38.41	10.68	24.35	2.18	1.02	22.54	11.28	1.35
5500	25.12	38.70	10.91	24.99	2.31	1.03	22.08	10.74	1.39
5600	24.93	38.66	11.06	25.22	2.35	1.03	22.78	11.16	1.41
5700	24.72	39.05	11.38	23.80	2.51	1.03	22.47	11.11	1.45
5800	24.49	39.92	11.74	21.58	2.83	1.03	22.33	10.87	1.51
5900	24.26	39.00	12.18	19.90	2.63	1.01	22.69	11.36	1.53
6000	24.01	38.82	12.62	18.30	2.65	1.01	22.26	10.98	1.58

## Typical Performance Curves

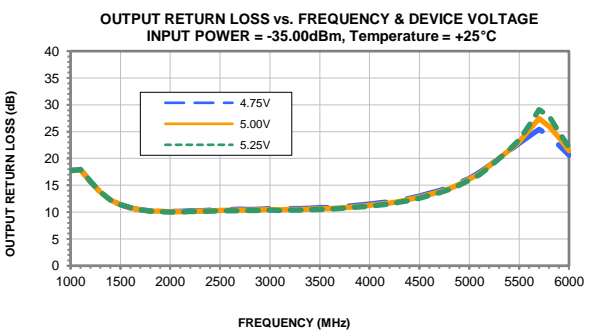
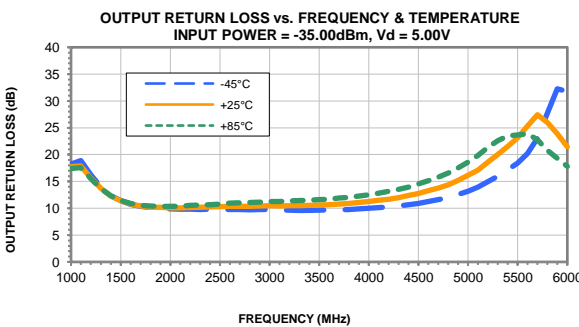
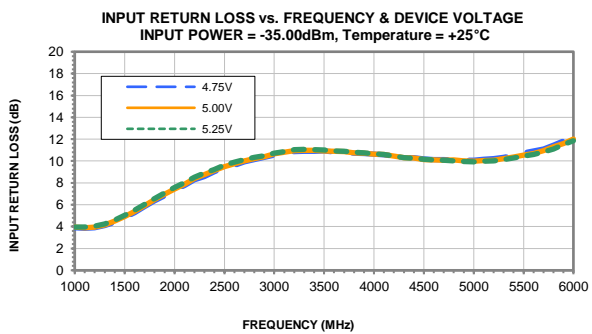
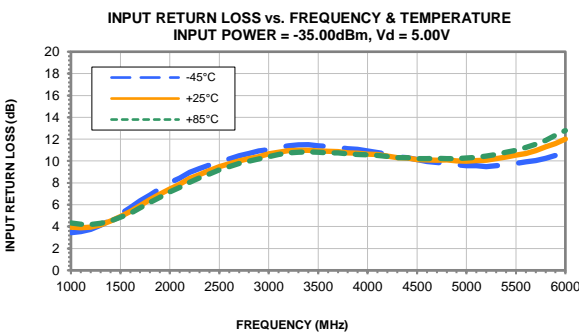
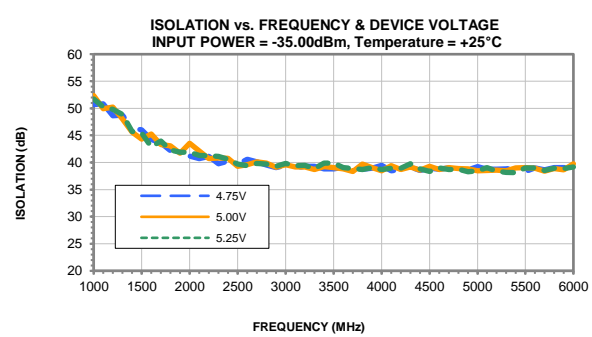
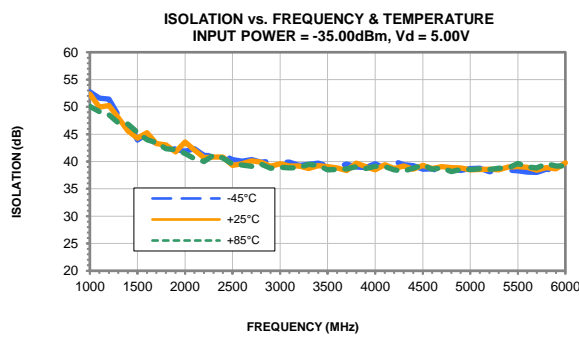
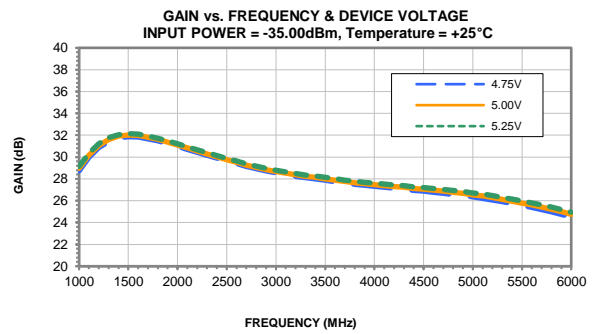
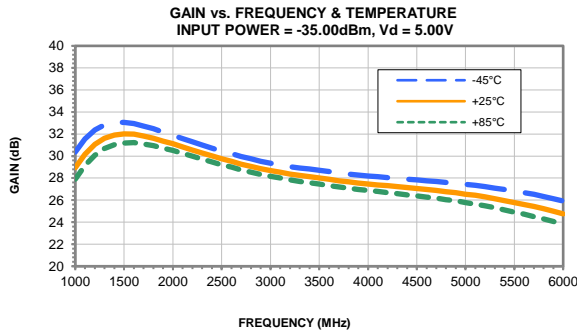

## Typical Performance Curves

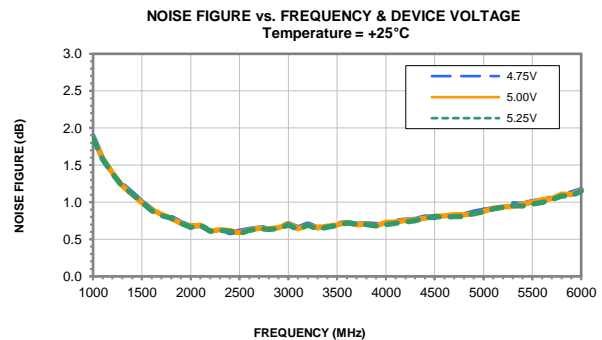
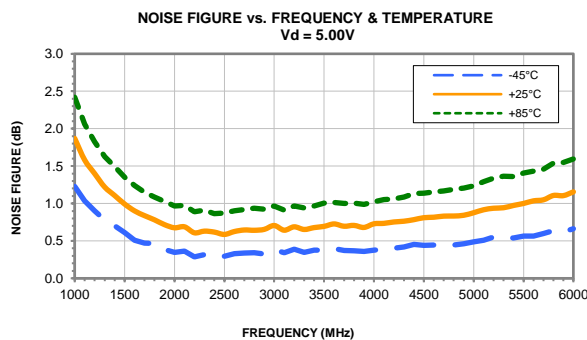
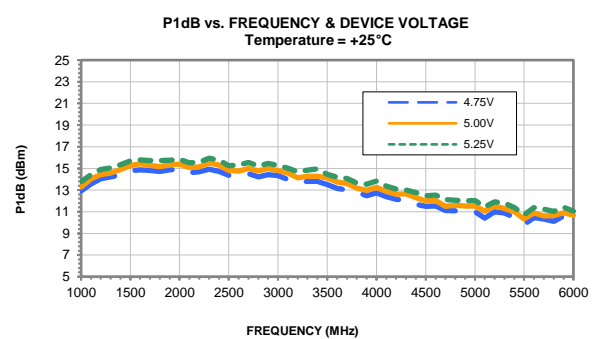
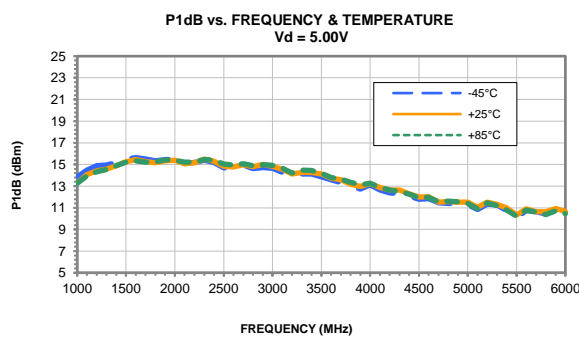
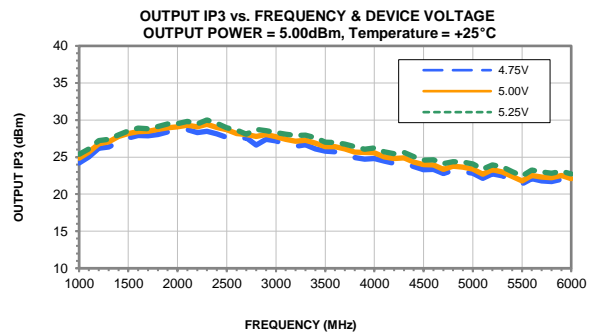
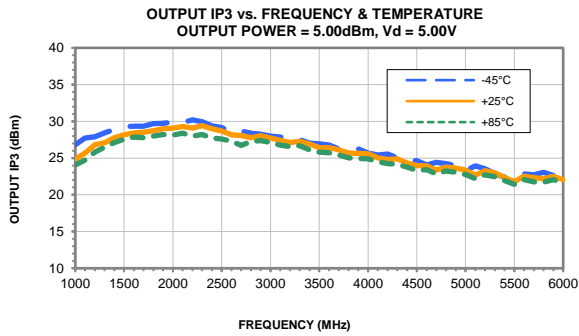



### Outline Dimensions

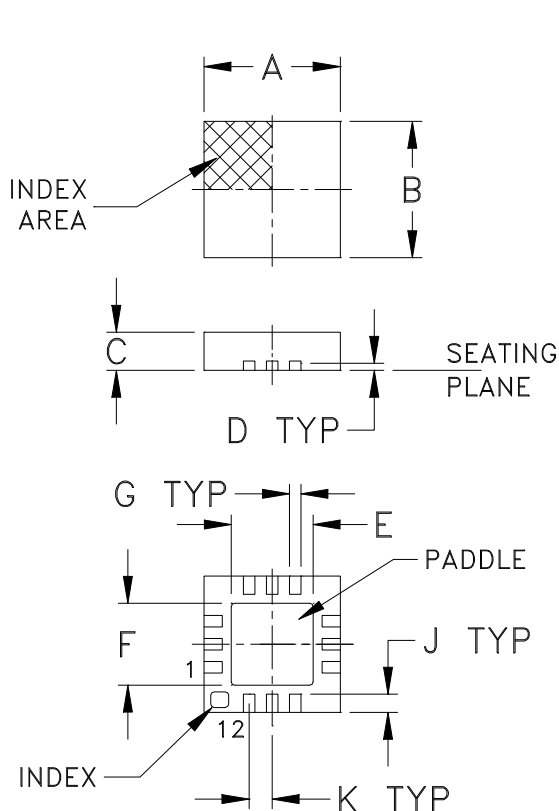

### PCB Land Pattern

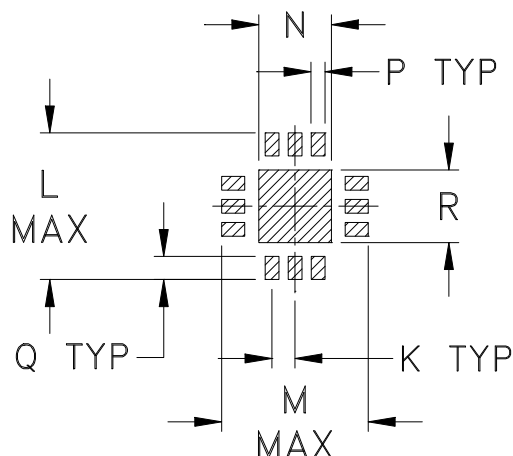

Suggested Layout,  
Tolerance to be within  $\pm .002$

CASE #	A	B	C	D	E	F	G	H	J	K	L	M	N
DQ1225	.118 (3.00)	.118 (3.00)	.035 (0.89)	.008 (0.20)	.057 (1.45)	.057 (1.45)	.009 (0.23)	-- --	.016 (0.41)	.020 (0.51)	.127 (3.22)	.127 (3.22)	.049 (1.25)

CASE #	P	Q	R	S	T	WT. GRAM
DQ1225	.010 (0.25)	.020 (0.51)	.049 (1.25)	-- --	-- --	.02

Dimensions are in inches (mm). Tolerances: 2Pl.  $\pm .01$ ; 3 Pl.  $\pm .004$

#### Notes:

- Case material: Plastic.
- Termination finish:
  - For RoHS Case Styles: Tin-Silver alloy plate over Nickel barrier or Matte-Tin. All models, (+) suffix. See Data sheet.
  - For RoHS-5 Case Styles: Tin-Lead plate. All models, no (+) suffix.



Distribution Centers NORTH AMERICA 800-654-7949 • 417-335-5935 • Fax 417-335-5945 • EUROPE 44-1252-832600 • Fax 44-1252-837010

Mini-Circuits ISO 9001 & ISO 14001 Certified

INTERNET <http://www.minicircuits.com>

P.O. Box 350166, Brooklyn, New York 11235-0003 (718) 934-4500 Fax (718) 332-4661

# Tape & Reel Packaging TR-F66

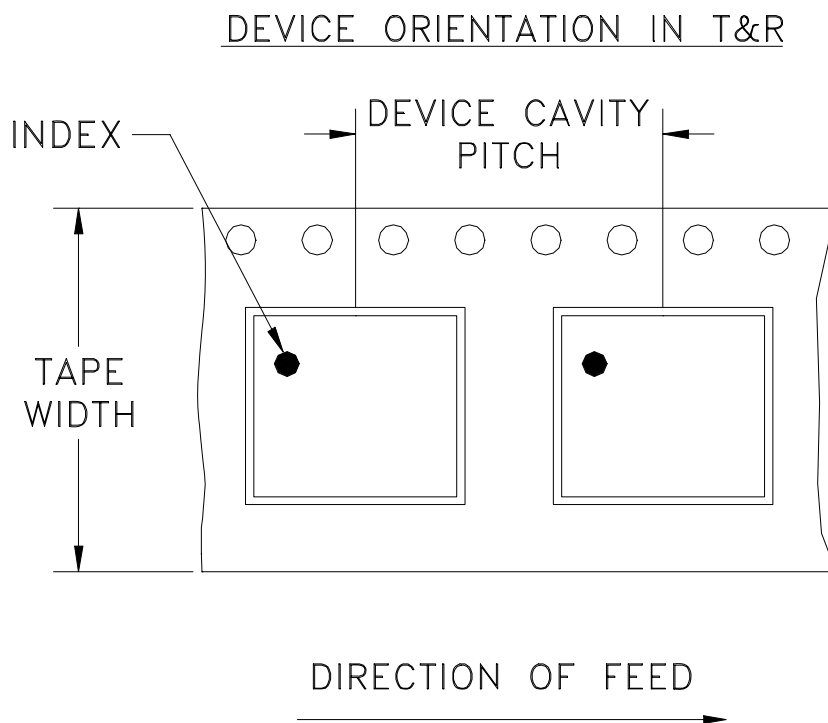

Tape Width, mm	Device Cavity Pitch, mm	Reel Size, inches	Devices per Reel see note	
8	4	7	Small quantity standard	20
				50
				100
				200
				500
		7	Standard	1000, 2000

Note: Please consult individual model data sheet to determine device per reel availability.

Mini-Circuits carrier tape materials provide protection from ESD (Electro-Static Discharge) during handling and transportation. Tapes are static dissipative and comply with industry standards EIA-481/EIA-541.

Go to: [www.minicircuits.com/pages/pdfs/tape.pdf](http://www.minicircuits.com/pages/pdfs/tape.pdf)



INTERNET <http://www.minicircuits.com>

P.O. Box 350166, Brooklyn, New York 11235-0003 (718) 934-4500 Fax (718) 332-4661

Distribution Centers NORTH AMERICA 800-654-7949 • 417-335-5935 • Fax 417-335-5945 • EUROPE 44-1252-832600 • Fax 44-1252-837010

Mini-Circuits ISO 9001 & ISO 14001 Certified

THIRD ANGLE PROJECTION

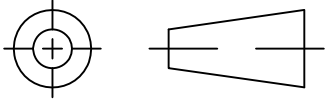

REVISIONS

REV	ECN No.	DESCRIPTION	DATE	DR	AUTH
OR	M170202	NEW RELEASE	10/02/18	GF	GH
A	M171004	UPDATED TEST BOARDS	11/15/18	ITG	GH

SUGGESTED MOUNTING CONFIGURATION FOR  
DQ1225 CASE STYLE, "12AM02" PIN CODE

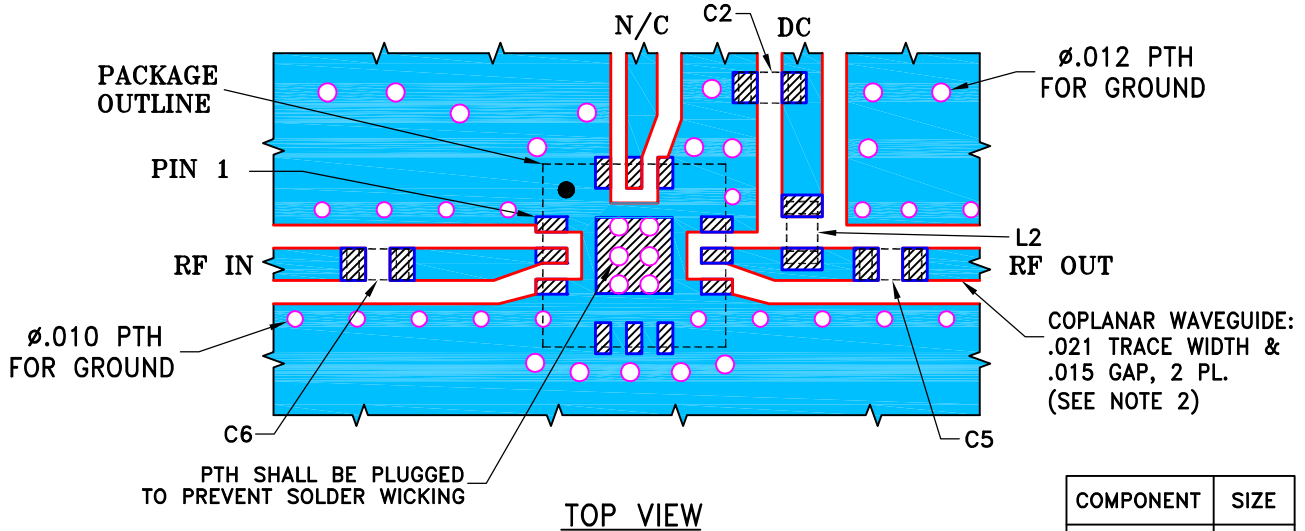

STACK-UP DIAGRAM

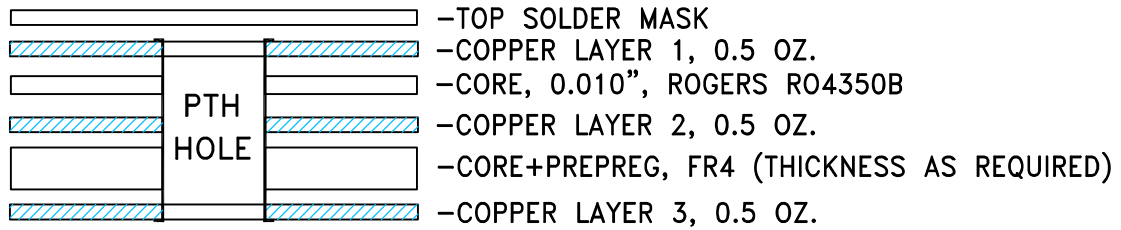

1. TOTAL FINISHED THICKNESS 0.065" ± 10%.
2. PTH HOLES PRESENT FROM COPPER LAYER 1 TO 3.

NOTES:

1. PCB IS MULTILAYER PCB, SEE STACK-UP DIAGRAM.
2. TRACE WIDTH & GAP PARAMETERS ARE SHOWN FOR ROGERS R04350B WITH DIELECTRIC THICKNESS .010" ± .001"; COPPER: 1/2 OZ. FOR OTHER MATERIALS TRACE WIDTH AND GAP MAY NEED TO BE MODIFIED.
3. CHIP COMPONENT FOOT PRINTS SHOWN FOR REFERENCE. FOR COMPONENT VALUES REFER TO TB-PMA3-63GLN+ OR TB-PMA3-352GLN+.
4. COPPER LAYERS L2 & L3 OF THE PCB ARE CONTINUOUS GROUND PLANES.

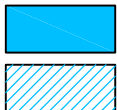

DENOTES PCB COPPER LAYOUT WITH SMOBC (SOLDER MASK OVER BARE COPPER)

DENOTES COPPER LAND PATTERN FREE OF SOLDER MASK

UNLESS OTHERWISE SPECIFIED	INITIALS	DATE
DIMENSIONS ARE IN INCHES	DRAWN GF	09/26/18
TOLERANCES ON:	CHECKED IL	09/26/18
2 PL DECIMALS ±	APPROVED GH	10/02/18
3 PL DECIMALS ± .005		
ANGLES ±		
FRACTIONS ±		



Mini-Circuits®

13 Neptune Avenue  
Brooklyn NY 11235

PL, 12AM02, DQ1225, TB-PMA3-XXXGLN+

SIZE	CODE IDENT	DRAWING NO:	REV:
A	15542	98-PL-611	A
FILE:	98PL611	SCALE: 8:1	SHEET: 1 OF 1

Mini-Circuits®

THIS DOCUMENT AND ITS CONTENTS ARE THE PROPERTY OF MINI-CIRCUITS. EXCEPT FOR USE EXPRESSLY GRANTED, IN WRITING, TO ITS VENDORS, VENDEE AND THE UNITED STATES GOVERNMENT, MINI-CIRCUITS RESERVES ALL PROPRIETARY DESIGN, USE, MANUFACTURING AND REPRODUCTION RIGHTS THERETO. THESE CONTENTS SHALL NOT BE USED, DUPLICATED OR DISCLOSED TO ANY OUTSIDE PARTY, IN WHOLE OR IN PART, WITHOUT WRITTEN PERMISSION OF MINI-CIRCUITS.

# Evaluation Board and Circuit

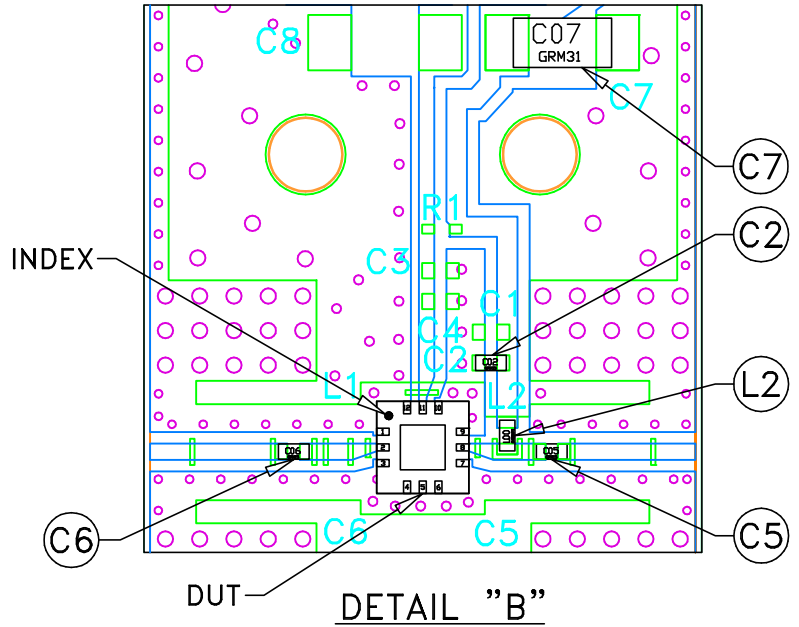
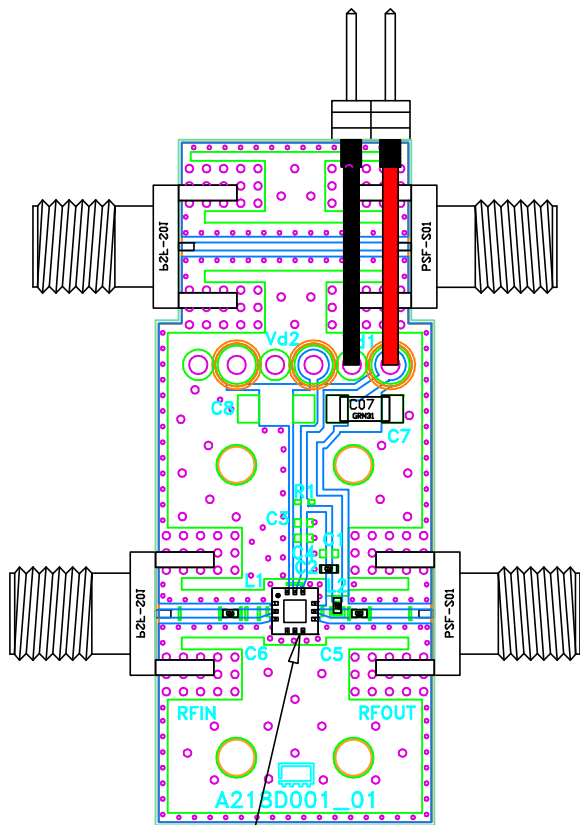

SEE DETAL "B"

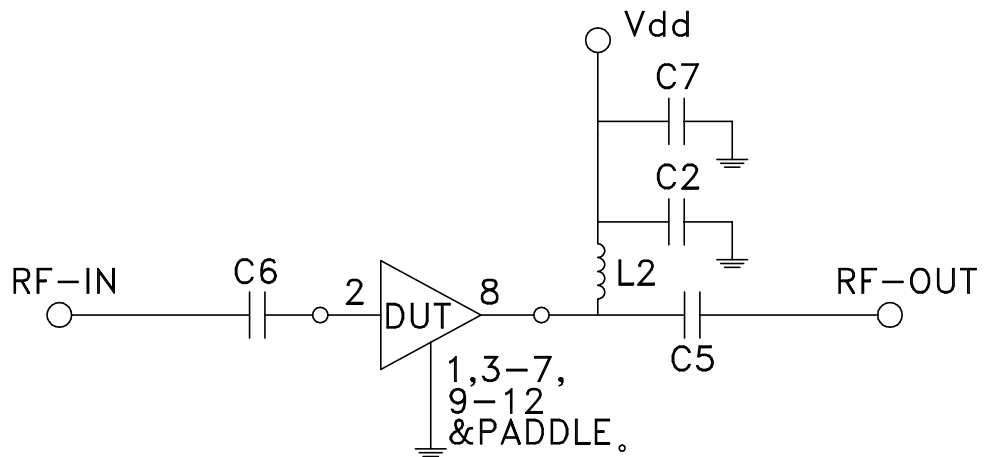

Schematic Diagram

Component	Size	Value	Part Number	Manufacturer
C2	0402	100pF	GRM1555C1H101JA01D	Murata
C5	0402	22pF	GRM1555C1H220JA01D	Murata
C6	0402	22pF	GRM1555C1H220JA01D	Murata
C7	1206	10uF	GRM31CR61H106KA12L	Murata
L2	0402	10nH	LQG15HS10NJ02D	Murata

## NOTES:

1. SMA Female Connectors.
2. PCB Material: Roger R04350B or equivalent, Dielectric constant=3.5, Thickness=0.01 inch

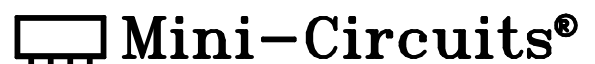

All Mini-Circuits products are manufactured under exacting quality assurance and control standards, and are capable of meeting published specifications after being subjected to any or all of the following physical and environmental test.

Specification	Test/Inspection Condition	Reference/Spec
Operating Temperature	-40° to 85°C Ambient Environment	Individual Model Data Sheet
Storage Temperature	-55° to 100° C or -65° to 150° Ambient Environment	Individual Model Data Sheet
Thermal Shock	-55° to 100°C, 100 cycles	MIL-STD-202, Method 107, Condition A-3, except +100°C
Mechanical Shock	1.5Kg, 0.5 ms, 5 shock pulses, Y1 direction only	MIL-STD-883, Method 2002, Condition B, except Y1 direction only
Vibration (Variable Frequency)	50g peak	MIL-STD-883, Method 2007, Condition B
Autoclave	15 psig, 100% RH, 121°C, 96 hours	JESD22-A102, Condition C
HAST	130°C, 85% RH, 96 hours	JESD22-A110
Solderability	10X Magnification	J-STD-002, Para 4.2.5, Test S, 95% Coverage
Solder Reflow Heat	Sn-Pb Eutetic Process: 240°C peak Pb-Free Process: 260°C peak	J-STD-020, Table 4-1, 4-2 and 5-2; Figure 5-1
Moisture Sensitivity: Level 1	Bake at 125°C for 24 hours Soak at 85°C/85% RH for 168 hours, Reflow 3 cycles at 260°C peak	J-STD-020
Marking Resistance to Solvents	Isopropyl alcohol + mineral spirits at 25°C; terpene defluxer at 25°C; distilled water + proylene glycol monomethyl ether +	MIL-STD-202, Method 215



All Mini-Circuits products are manufactured under exacting quality assurance and control standards, and are capable of meeting published specifications after being subjected to any or all of the following physical and environmental test.

Specification	Test/Inspection Condition	Reference/Spec
---------------	---------------------------	----------------

monoethanolamine at 63°C to 70°C